

30
60

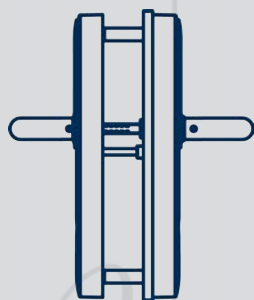

DE Kurzanleitung
EN Quick Guide
FR Guide abrégé
NL Korte handleiding
IT Guida breve
DK Kort vejledning
SE Snabbguide

BS25.990613
11.03.2024



SmartHandle AX Advanced Security fitting

Simons  **Voss**
technologies

Abbildungen/Images	3
deutsch	29
english	35
français	41
nederlands	47
italiano	53
dansk	59
svensk	65

4. Design

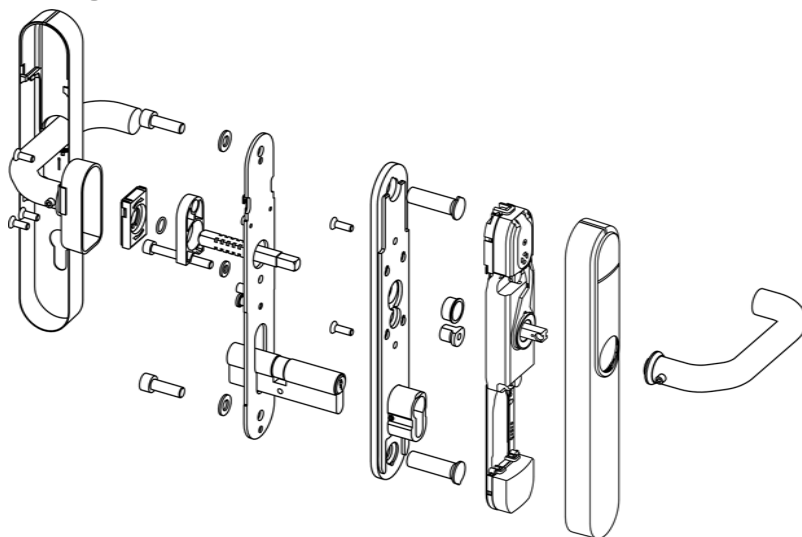

Inside

Outside

5. Prepare door (drilling template)



PH2



Ø13.0



2

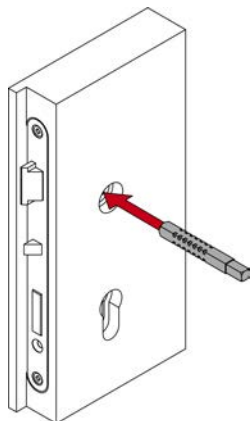

 3

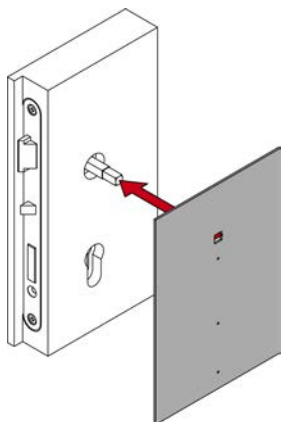

 4

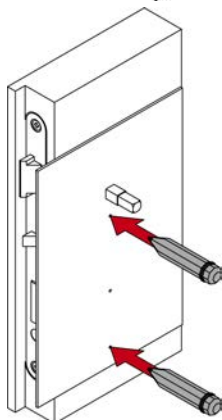

 5

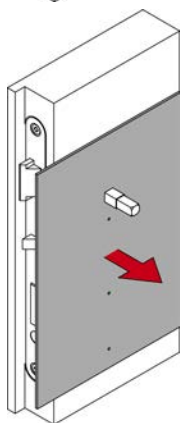

6

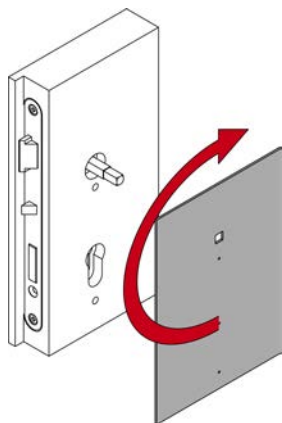

7

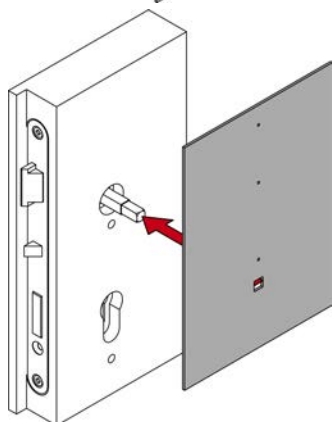

8

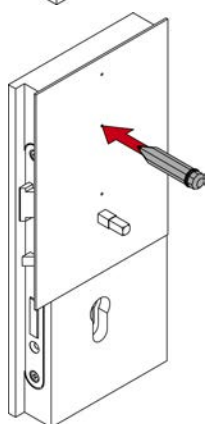

 9

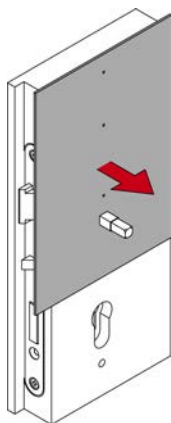

 10

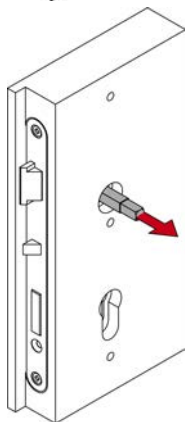

 11



PH2

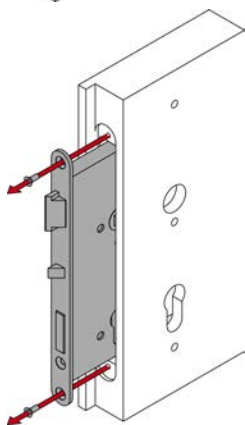

12

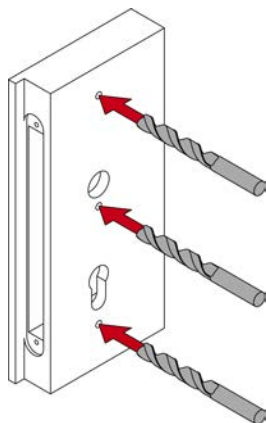
Ø13.0

13

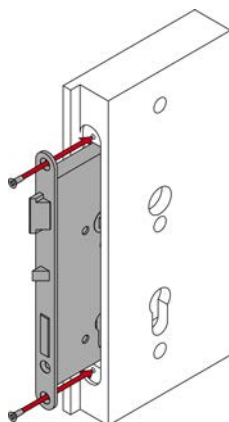
PH2

6. Installing the fitting



PH2



SW5



SW6



TX15

14

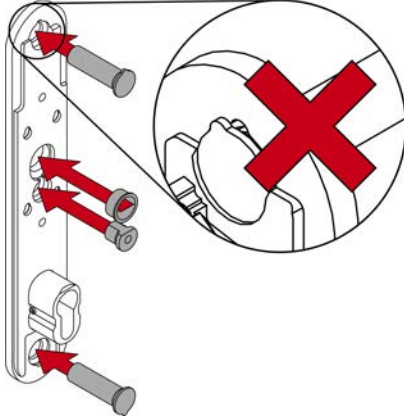

15

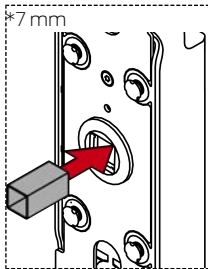

16

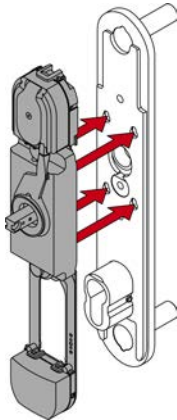

17

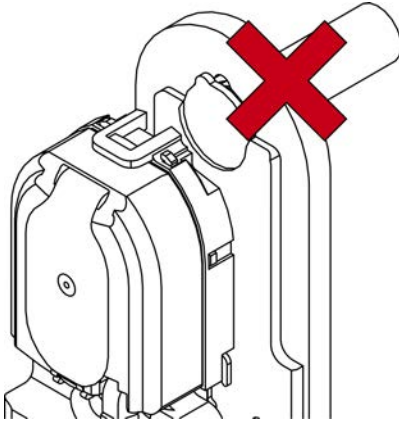

18

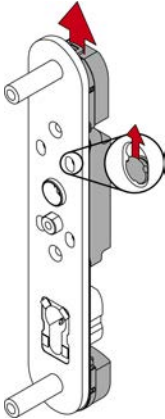

19



20



PH2

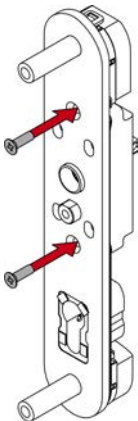

21

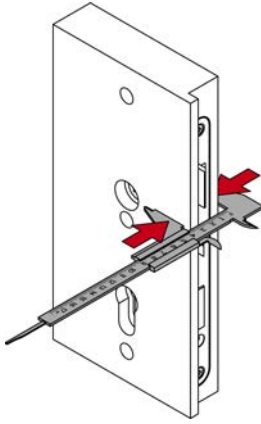

Size	Door thickness (mm)	Screws (M8)	Screw (M6)
S	39 - <45	25	50
S	45 - <47.5	25	55
S	47.5 - <50	35	55
S	50 - <55	35	60
M	54 - <60	40	65
M	60 - <65	40	70
M	65 - <70	50	75
M	70 - <75	50	80
L	74 - <80	60	85
L	80 - <85	60	90
L	85 - <90	70	95
L	90 - <95	70	100

22

M8×25

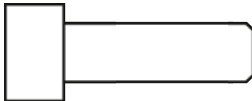

23

M8×35

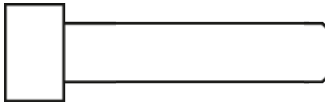

24

M8×40

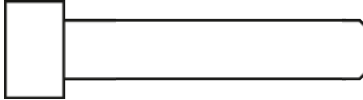

25

M8×50

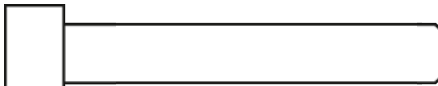

26

M8×60

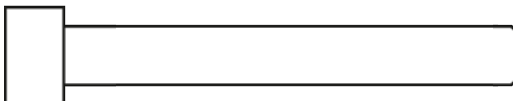

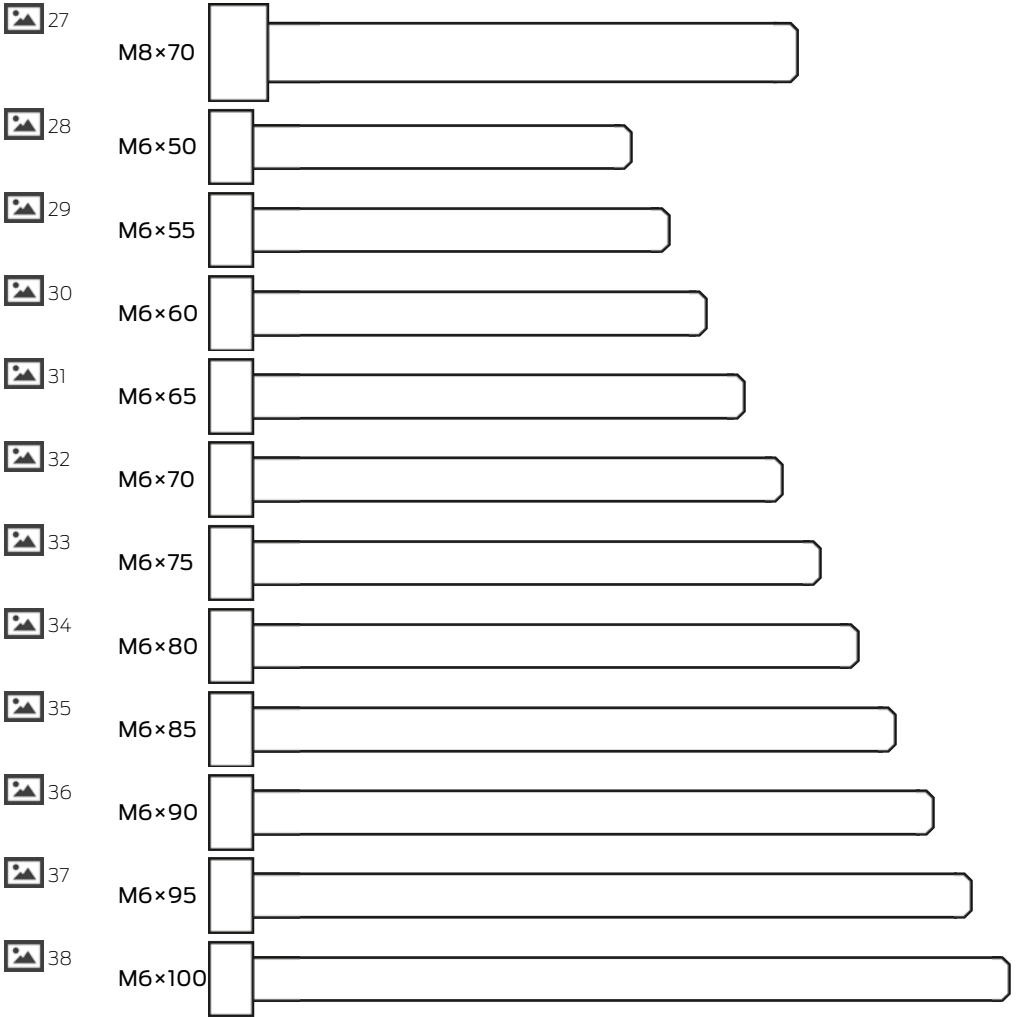

39

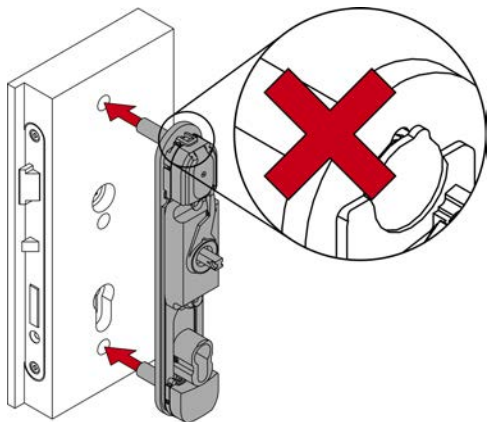

17

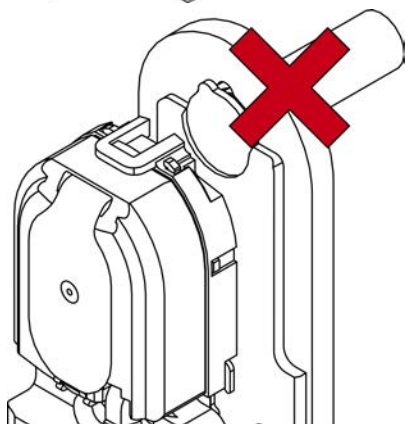

41



SW5



SW6

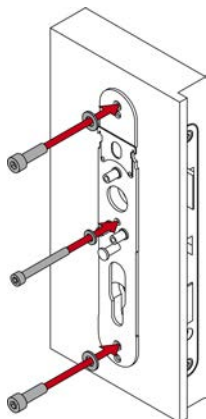

42

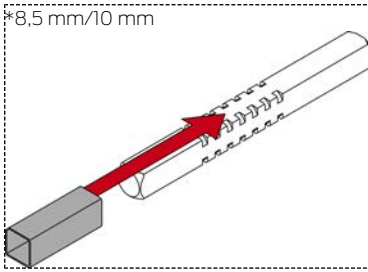

43

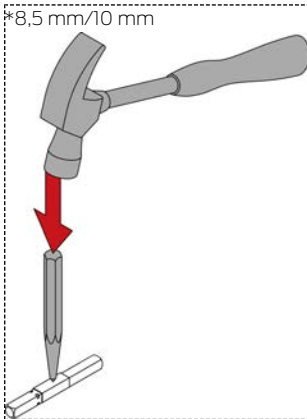

44

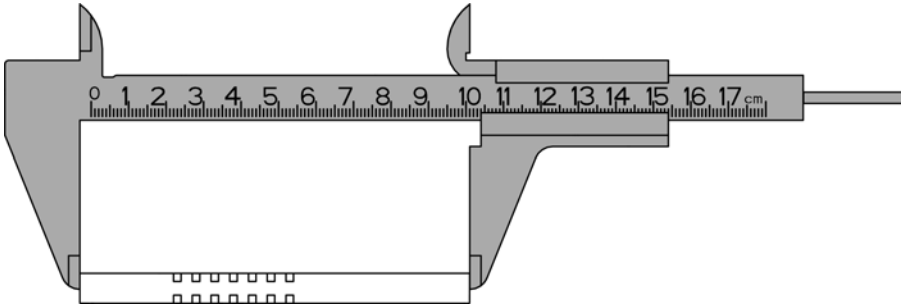

45

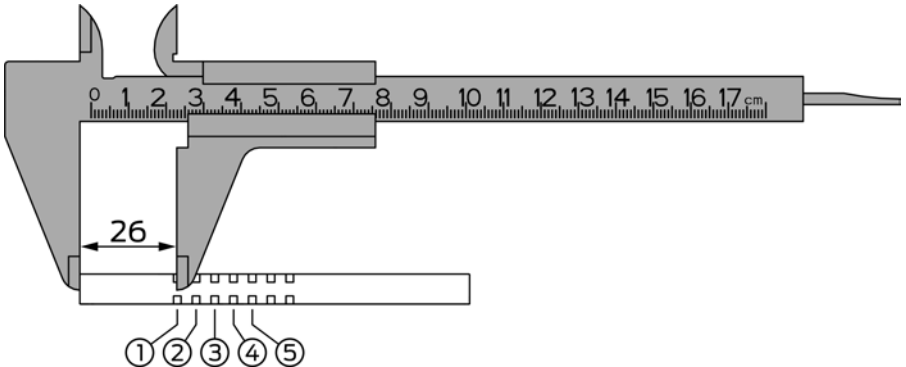

Area	Door thickness (mm)	Spindle length (mm)	Ring position
S	39 - <43	104	2
S	39 - <43	114	4
S	43 - <48	104	1
S	43 - <48	114	3
S	48 - <53	114	2
S	53 - 55	114	1
M	54 - <58	124	3
M	54 - <58	134	5
M	58 - <63	124	2
M	58 - <63	134	4
M	63 - <68	124	1
M	63 - <68	134	3
M	66 - <73	134	2
M	73 - 75	134	1
L	74 - <78	144	3
L	74 - <78	154	5
L	78 - <83	144	2
L	78 - <83	154	4
L	83 - <88	144	1
L	83 - <88	154	3
L	88 - <93	154	2
L	93 - 95	154	1



46

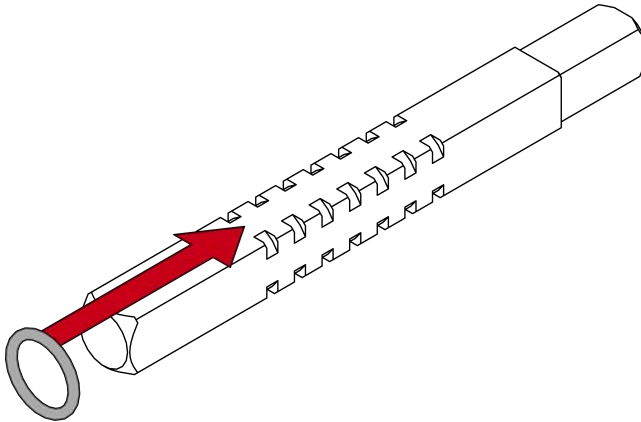

47

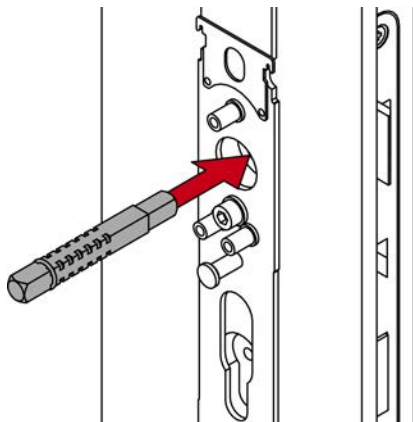

48

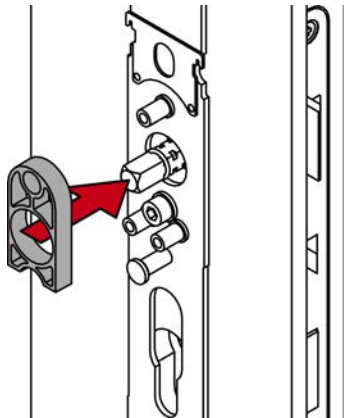

49

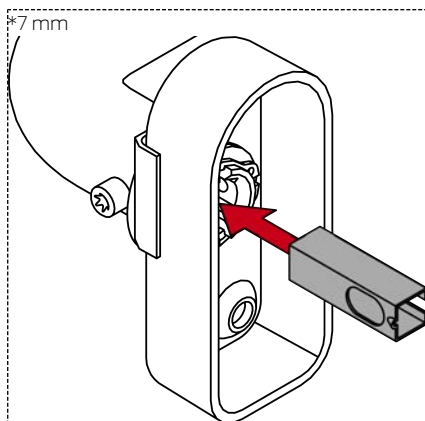

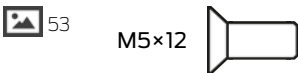
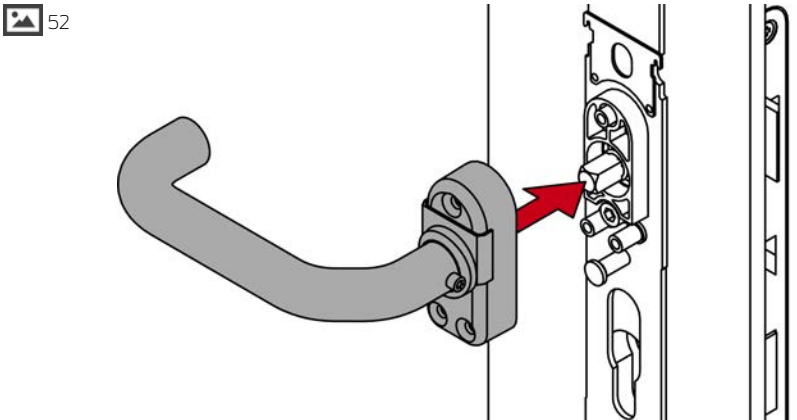
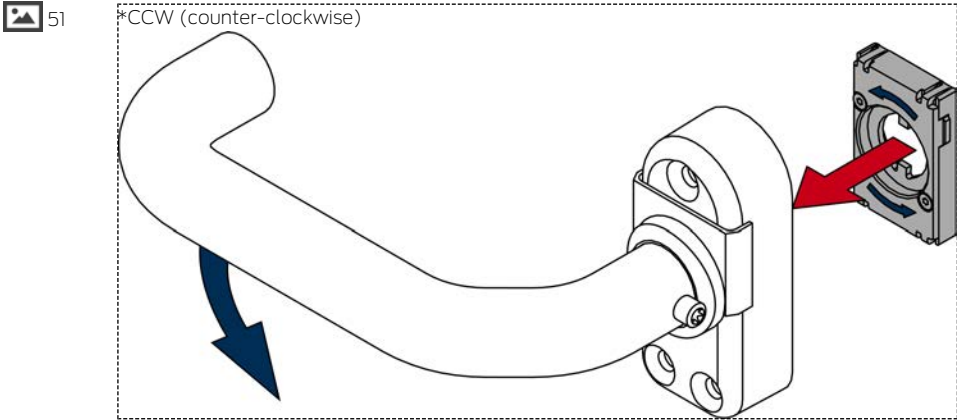
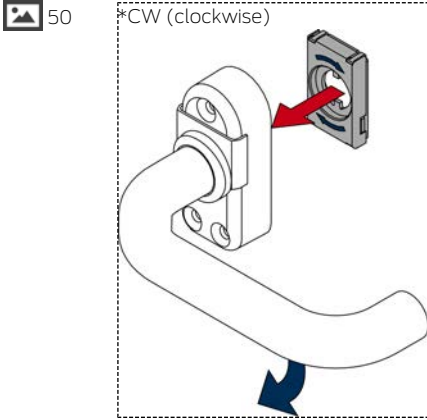

54



PH2

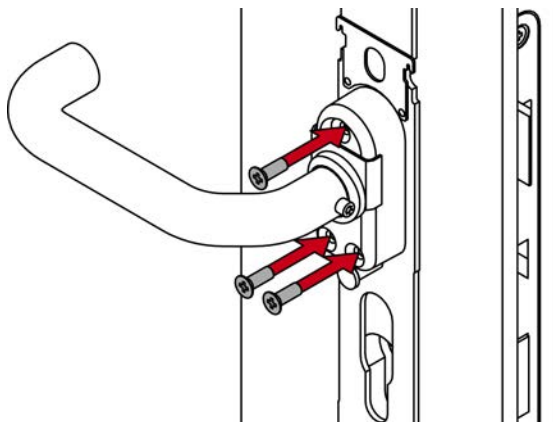

55

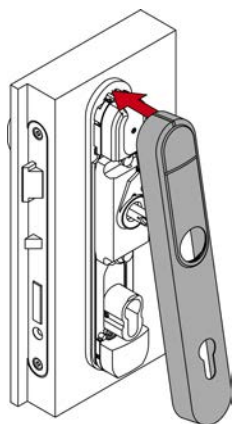

56

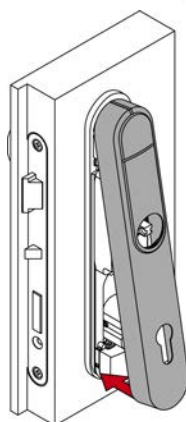

 57



 58



 59

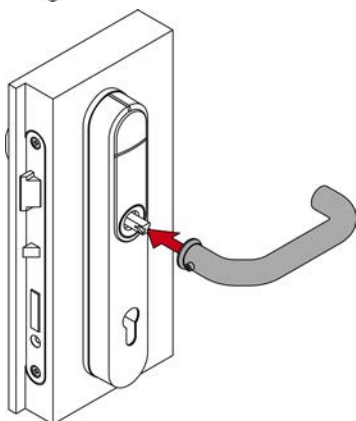

60



TX15

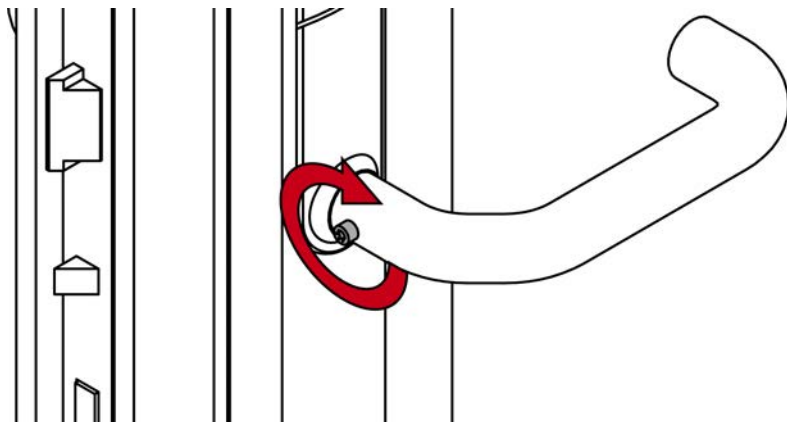

61



TX15

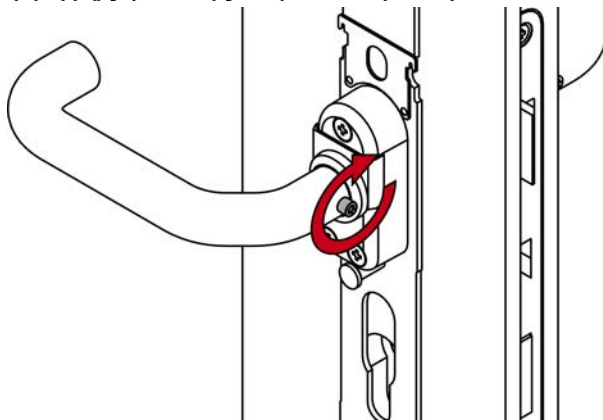

62

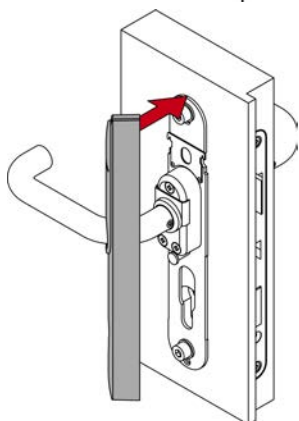

63

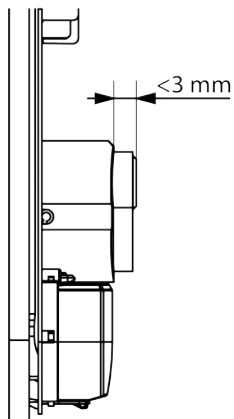

64

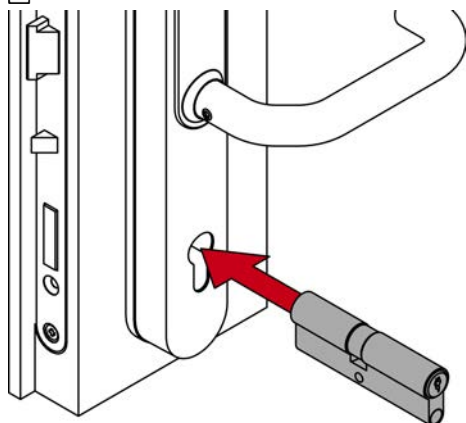

65



PH2

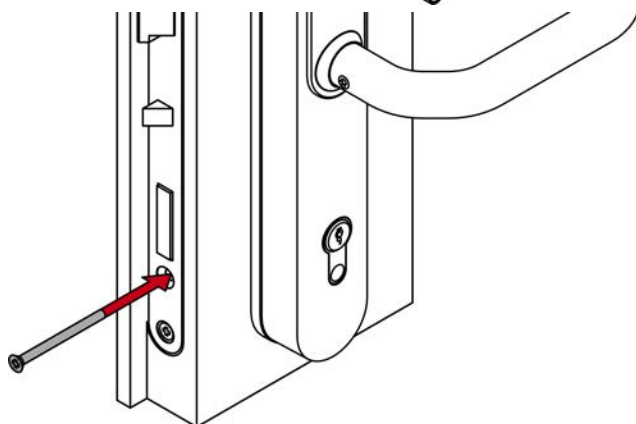

7. Removing the fitting (protective fitting)



SW1.5



66



SW1.5

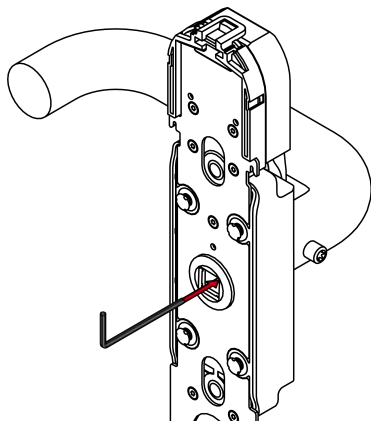

67



SW1.5

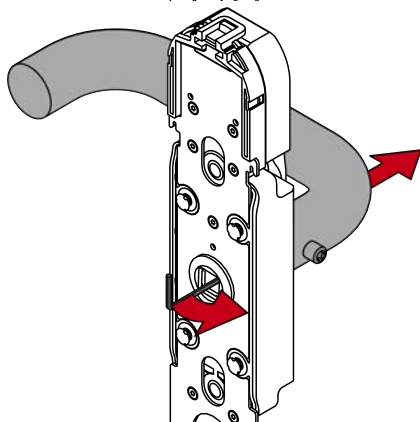

8. Replacing the batteries



68

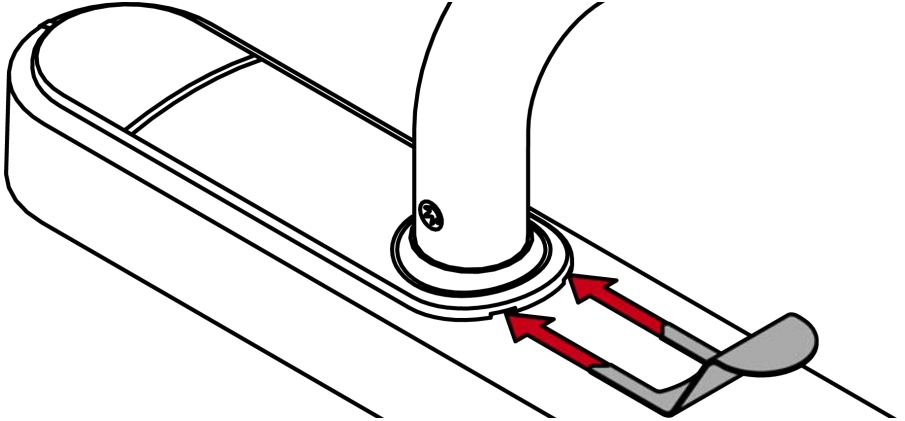

69

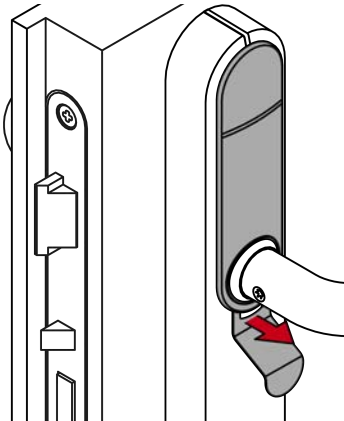

70

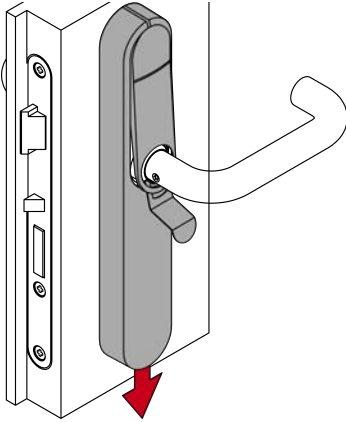

71

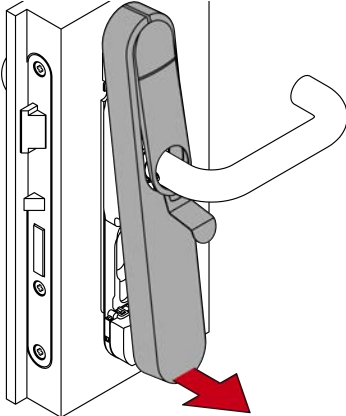

72

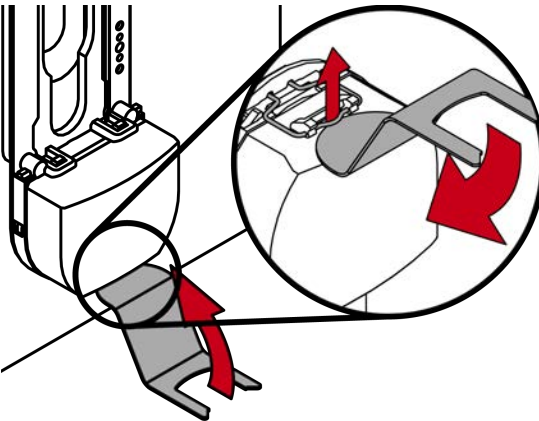

 73

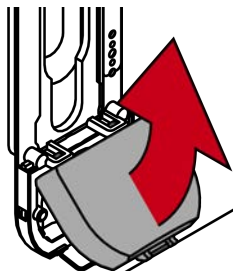

 74

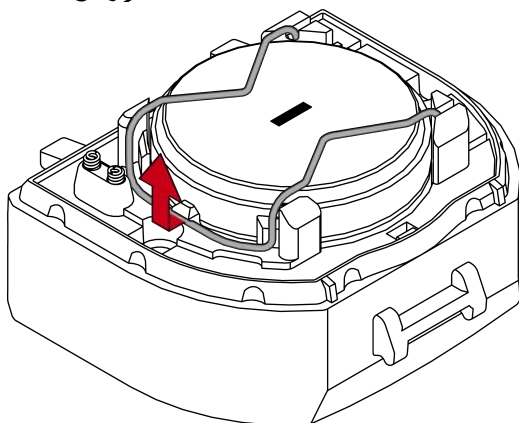

 75

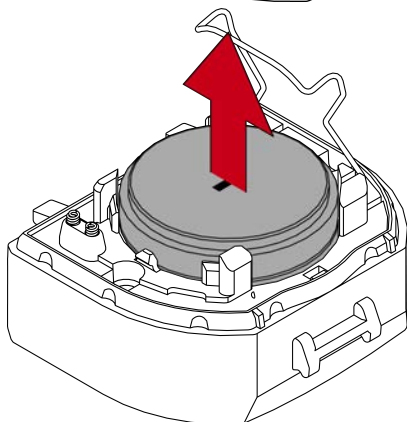

76

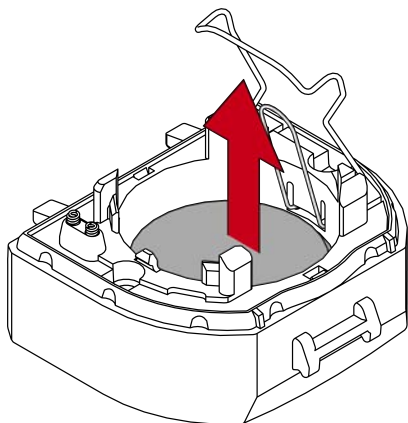

77

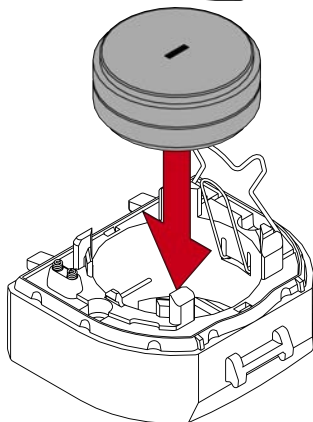

78

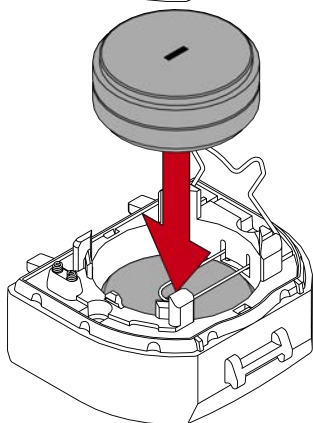

 79

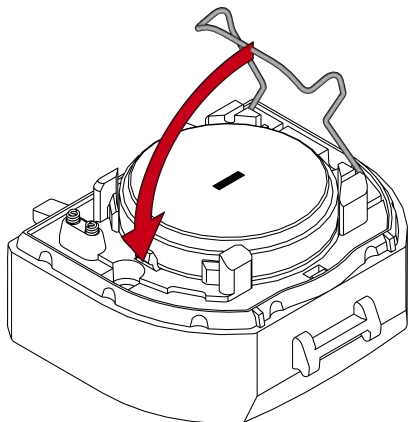

 80

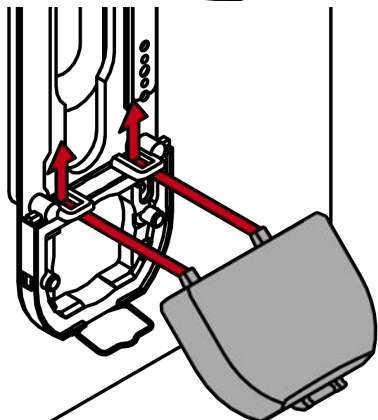

 81

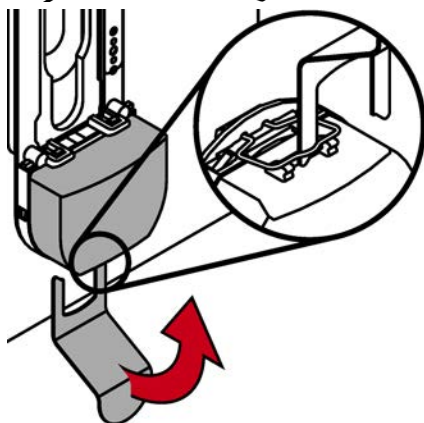

82

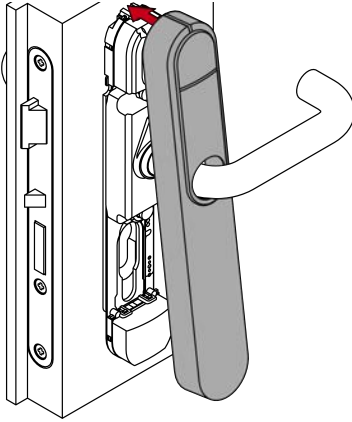

83

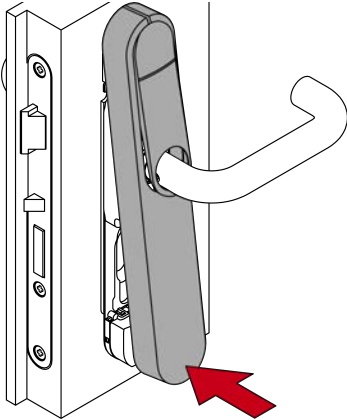

84

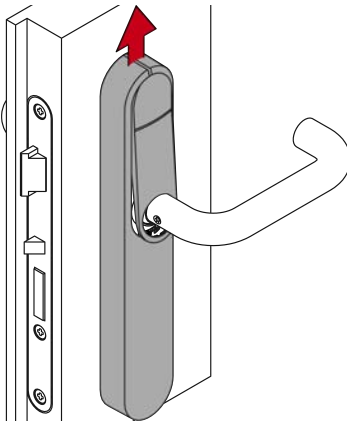

 85

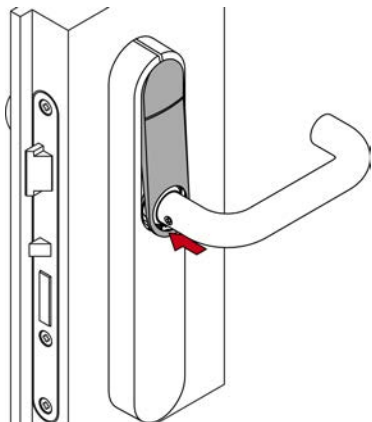

11. Help and other information

 86



Inhaltsverzeichnis

1.	Allgemeine Sicherheitshinweise.....	30
2.	Produktspezifische Sicherheitshinweise	31
3.	Lieferumfang.....	31
4.	Aufbau.....	31
5.	Tür vorbereiten (Bohrschablone).....	31
6.	Beschlag montieren.....	31
7.	Beschlag demontieren (Schutzbeschlag)	33
8.	Batterien wechseln	33
9.	Technische Daten.....	33
10.	Konformitätserklärung	34
11.	Hilfe und weitere Informationen	34

1. Allgemeine Sicherheitshinweise

Signalwort: Mögliche unmittelbare Auswirkungen bei Nichtbeachtung
WARNUNG: Tod oder schwere Verletzung (möglich, aber unwahrscheinlich),
VORSICHT: Leichte Verletzung, **ACHTUNG:** Sachschäden oder Fehlfunktionen, **HINWEIS:** Geringe oder keine



WARNUNG

Versperrter Zugang

Durch fehlerhaft montierte und/oder programmierte Komponenten kann der Zutritt durch eine Tür versperrt bleiben. Für Folgen eines versperrten Zutritts wie Zugang zu verletzten oder gefährdeten Personen, Sachschäden oder anderen Schäden haftet die SimonsVoss Technologies GmbH nicht!

Versperrter Zugang durch Manipulation des Produkts

Wenn Sie das Produkt eigenmächtig verändern, dann können Fehlfunktionen auftreten und der Zugang durch eine Tür versperrt werden.

- ❌ Verändern Sie das Produkt nur bei Bedarf und nur in der Dokumentation beschriebenen Art und Weise.

Batterie nicht einnehmen. Verbrennungsgefahr durch gefährliche Stoffe

Dieses Produkt enthält Lithium-Knopfzellen. Wenn die Knopfzelle verschluckt wird, können schwere innere Verbrennungen innerhalb von gerade einmal zwei Stunden auftreten und zum Tode führen.

1. Halten Sie neue und gebrauchte Batterien von Kindern fern.
2. Wenn das Batteriefach nicht sicher schließt, dann benutzen Sie das Produkt nicht mehr und halten Sie es von Kindern fern.
3. Wenn Sie meinen, dass Batterien verschluckt wurden oder sich in irgendeinem Körperteil befinden, suchen Sie unverzüglich medizinische Hilfe auf.

Explosionsgefahr durch falschen Batterietyp

Das Einsetzen falscher Batterietypen kann zu einer Explosion führen.

- ❌ Verwenden Sie ausschließlich die in den technischen Daten spezifizierten Batterien.



VORSICHT

Feuergefahr durch Batterien

Die eingesetzten Batterien können bei Fehlbehandlung eine Feuer- oder Verbrennungsgefahr darstellen.

1. Versuchen Sie nicht, die Batterien aufzuladen, zu öffnen, zu erhitzen oder zu verbrennen.
2. Schließen Sie die Batterien nicht kurz.

ACHTUNG

Beschädigung durch elektrostatische Entladung (ESD) bei geöffnetem Gehäuse

Dieses Produkt enthält elektronische Bauteile, die durch elektrostatische Entladungen beschädigt werden können.

1. Verwenden Sie ESD-gerechte Arbeitsmaterialien (z.B. Erdungsarmband).
2. Erden Sie sich vor Arbeiten, bei denen Sie mit der Elektronik in Kontakt kommen könnten. Fassen Sie dazu geerdete metallische Oberflächen an (z.B. Türzargen, Wasserrohre oder Heizungsventile).

Beschädigung durch Öle, Fette, Farben und Säuren

Dieses Produkt enthält elektronische und/oder mechanische Bauteile, die durch Flüssigkeiten aller Art beschädigt werden können.

- ❌ Halten Sie Öle, Fette, Farben und Säuren vom Produkt fern.

Beschädigung durch aggressive Reinigungsmittel

Die Oberfläche dieses Produkts kann durch ungeeignete Reinigungsmittel beschädigt werden.

- ❌ Verwenden Sie ausschließlich Reinigungsmittel, die für Kunststoff- bzw. Metalloberflächen geeignet sind.

Beschädigung durch mechanische Einwirkung

Dieses Produkt enthält elektronische Bauteile, die durch mechanische Einwirkung aller Art beschädigt werden können.

1. Vermeiden Sie das Anfassen der Elektronik.
2. Vermeiden Sie sonstige mechanische Einwirkungen auf die Elektronik.

Beschädigung durch Verpolung

Dieses Produkt enthält elektronische Bauteile, die durch die Verpolung der Spannungsquelle beschädigt werden können.

- ❌ Verpolen Sie die Spannungsquelle nicht (Batterien bzw. Netzteile).

Störung des Betriebs durch Funkstörung

Dieses Produkt kann unter Umständen durch elektromagnetische oder magnetische Störungen beeinflusst werden.

- ❌ Montieren bzw. platzieren Sie das Produkt nicht unmittelbar neben Geräten, die elektromagnetische oder magnetische Störungen verursachen können (Schaltnetzteile!).

Störung der Kommunikation durch metallische Oberflächen

Dieses Produkt kommuniziert drahtlos. Metallische Oberflächen können die Reichweite des Produkts erheblich reduzieren.

- ❌ Montieren bzw. platzieren Sie das Produkt nicht auf oder in der Nähe von metallischen Oberflächen.



HINWEIS

Bestimmungsgemäßer Gebrauch

SimonsVoss-Produkte sind ausschließlich für das Öffnen und Schließen von Türen und vergleichbaren Gegenständen bestimmt.

- ❌ Verwenden Sie SimonsVoss-Produkte nicht für andere Zwecke.

Funktionsstörungen durch schlechten Kontakt oder unterschiedliche Entladung

Zu kleine/verunreinigte Kontaktfächen oder unterschiedliche entladene Batterien können zu Funktionsstörungen führen.

1. Verwenden Sie nur Batterien, die von SimonsVoss freigegeben sind.
2. Berühren Sie die Kontakte der neuen Batterien nicht mit den Händen.
3. Verwenden Sie saubere und fettfreie Handschuhe.
4. Tauschen Sie immer alle Batterien gleichzeitig aus.

Abweichende Zeiten bei G2-Schließungen

Die interne Zeiteinheit der G2-Schließungen hat eine technisch bedingte Toleranz von bis zu ± 15 Minuten pro Jahr.

Qualifikationen erforderlich

Die Installation und Inbetriebnahme setzt Fachkenntnisse voraus.

- ❌ Nur geschultes Fachpersonal darf das Produkt installieren und in Betrieb nehmen.

Änderungen bzw. technische Weiterentwicklungen können nicht ausgeschlossen und ohne Ankündigung umgesetzt werden.

Die deutsche Sprachfassung ist die Originalbetriebsanleitung. Andere Sprachen (Abfassung in der Vertragssprache) sind Übersetzungen der Originalbetriebsanleitung.

Lesen Sie alle Anweisungen zur Installation, zum Einbau und zur Inbetriebnahme und befolgen Sie diese. Geben Sie diese Anweisungen und jegliche Anweisungen zur Wartung an den Benutzer weiter.

2. Produktspezifische Sicherheitshinweise

ACHTUNG

Erschwerte Montage durch herausgedrückte Gewindehülsen

Die Gewindehülsen im Beschlag sind mit einer Presspassung montiert. Übermäßiges Drücken beim Festschrauben des Beschlags auf der Fixierplatte kann dazu führen, dass die Gewindehülsen aus dem Beschlag rutschen.

1. Drücken Sie beim Verschrauben des Modulträgers nicht auf die Schrauben.
2. Verwenden Sie einen Finger an den Enden Gewindehülsen, um während des Verschraubens gegenzuhalten.

3. Lieferumfang













- SmartHandle AX Advanced Schutzbeschlag
 - Spezialwerkzeug
 - Kurzanleitung
- Je nach Variante:
- Adaptersatz 7-mm-Vierkant
 - Adapterhülse 8,5-mm-Vierkant
 - Adapterhülse 10-mm-Vierkant

4. Aufbau





5. Tür vorbereiten (Bohrschablone)

- ✓ Stift oder Anreißnadel vorhanden.
- ✓ Bohrmaschine vorhanden.
- ✓ Geeigneter Bohrer vorhanden (Ø 13 mm).
- ✓ PH2-Schraubendreher vorhanden.

1. Stecken Sie den Vierkant in das Einsteckschloss.
 
2. Stecken Sie die Bohrschablone auf den Vierkant.
 
3. Richten Sie die Bohrschablone mithilfe der aufgedruckten Skala senkrecht aus.
4. Markieren Sie die Bohrlöcher mit der Markierung 1.
 
5. Entfernen Sie die Bohrschablone und drehen Sie sie um 180 Grad.
 
6. Stecken Sie die Bohrschablone auf den Vierkant.
 
7. Richten Sie die Bohrschablone mithilfe der aufgedruckten Skala senkrecht aus.
 
8. Markieren Sie das Bohrloch mit der Markierung 2.
 
9. Entfernen Sie die Bohrschablone und den Vierkant.
 
10. Bauen Sie das Einsteckschloss aus.
 
11. Bohren Sie die benötigten Löcher.
 
12. Bauen Sie das Einsteckschloss ein.
 
13.
 

6. Beschlag montieren

- ✓ Tür vorgebohrt.
 - ✓ PH2-Schraubendreher vorhanden.
 - ✓ TX15-Schraubendreher vorhanden.
 - ✓ SW6-Sechskant-Schraubendreher vorhanden.
 - ✓ SW5-Sechskant-Schraubendreher vorhanden.
 - ✓ Messschieber vorhanden.
1. Setzen Sie das Vierkant-Schutzröhrchen und die Hülsenmutter in die Fixierplatte ein (kurze Hülsenmutter in der Mitte).
 
 2. Für 7-mm-Vierkant: Setzen Sie den Adapterschuh in die Vierkant-Aufnahme des Modulträgers.
 
 3. Stecken Sie den Modulträger in die Fixierplatte.
 





ACHTUNG

Beschädigung der Hülsenmutter durch unsauberes Einsetzen





Wenn die Nasen der Hülsenmutter nicht in den Aussparungen sitzen, dann können sie während der weiteren Montage beschädigt werden. In diesem Fall kann sich die Hülsenmutter mitdrehen und die Montage/Demontage wird erschwert.

- Achten Sie darauf, dass die Nasen der Hülsenmutter in den Aussparungen sitzen.



4. Schieben Sie den Modulträger nach oben.
 
5. Schrauben Sie mit den 16-mm-Schrauben den Modulträger an der Fixierplatte fest (PH2).
 
6. Messen Sie die Türdicke.
 
7.
 

Bereich	Türdicke (mm)	Schrauben (M8)	Schraube (M6)
S	39 - <45	25	50
S	45 - <47,5	25	55
S	47,5 - <50	35	55
S	50 - <55	35	60
M	54 - <60	40	65
M	60 - <65	40	70
M	65 - <70	50	75
M	70 - <75	50	80
L	74 - <80	60	85
L	80 - <85	60	90
L	85 - <90	70	95
L	90 - <95	70	100

7. Bestimmen Sie mit der gemessenen Türdicke die benötigten Schrauben.
 
- 
- 
- 



26



27



28



29



30



31



32



33



34



35



36



37



38

8. Stecken Sie den Modulträger mit der Fixierplatte in die Tür-Außenseite.



39

ACHTUNG**Beschädigung der Hülsenmuttern durch unsauberes Einsetzen**

Wenn die Nasen der Hülsenmuttern nicht in den Aussparungen sitzen, dann können sie während der weiteren Montage beschädigt werden. In diesem Fall kann sich die Hülsenmutter mitdrehen und die Montage/Demontage wird erschwert.

- Achten Sie darauf, dass die Nasen der Hülsenmuttern in den Aussparungen sitzen.



17

9. Schrauben Sie die Unterlegscheiben und die Innenplatte am Modulträger fest (kurze Schrauben SW6, lange Schraube in der Mitte SW5).



41

10. Für 8,5-mm- und 10-mm-Vierkant: Schieben Sie die Adapterhülse in die Mitte des Vierkants. Machen Sie mit Körner und Hammer eine Vertiefung in die Adapterhülse, um das Verrutschen zu verhindern.



42



43

11. Messen Sie die Gesamtlänge des Vierkants.



44

12. Ermitteln Sie die Innenseite des Vierkants (Vierkantende bis Mitte erster Rille = 26 mm).

13. Bestimmen Sie die Position des O-Rings mit der Tabelle.



45

Bereich	Türdicke (mm)	Vierkantlänge (mm)	Ringposition
S	39 - <43	104	2
S	39 - <43	114	4
S	43 - <48	104	1
S	43 - <48	114	3
S	48 - <53	114	2
S	53 - 55	114	1
M	54 - <58	124	3
M	54 - <58	134	5
M	58 - <63	124	2
M	58 - <63	134	4
M	63 - <68	124	1
M	63 - <68	134	3
M	66 - <73	134	2
M	73 - 75	134	1
L	74 - <78	144	3
L	74 - <78	154	5
L	78 - <83	144	2
L	78 - <83	154	4
L	83 - <88	144	1
L	83 - <88	154	3
L	88 - <93	154	2
L	93 - 95	154	1

14. Schieben Sie den O-Ring auf die berechnete Rille.



46

15. Stecken Sie den Vierkant mit der ringfreien Seite bis zum Anschlag in die Tür.



47

16. Stecken Sie das Auffüll-Profil auf die innenseitige Fixierplatte.



48

17. Für 7-mm-Vierkant: Setzen Sie die Adapterhülse so in den Innendrucker, dass die Aussparung zur Madenschraube zeigt.



49

18. Bestimmen Sie die gewünschte Drehrichtung Ihres Innendrückers.

19. Setzen Sie das Federelement entsprechend ein.



50



51

20. Stecken Sie die Innendrucker-Einheit auf den Vierkant.



52

21. Schrauben Sie mit den 12-mm-Schrauben die Innendrucker-Einheit auf die Fixierplatte (PH2).



53



54

22. Setzen Sie das Cover oben auf der Fixierplatte an.



55

23. Klappen Sie das Cover nach unten zu.



56

24. Schieben Sie das Cover nach oben.







57

25. Drücken Sie das Inlay fest.



58

26. Stecken Sie den Außendrücker auf.
 59
27. Schrauben Sie mit der Madenschraube den Außendrücker fest (TX15).
 60
28. Schrauben Sie mit der Madenschraube den Innendrücker fest (TX15).
 61
29. Montieren Sie ebenso das Cover für die Innenseite.
 62
30. Setzen Sie einen Schließzylinder ein.

**HINWEIS****Auflagen der Schutzbeschlag-Zulassung**

Die Zulassung des SmartHandle AX Advanced ist an Auflagen gebunden:

1. Achten Sie auf die Schutzklasse des Schließzylinders.
2. Das Gehäuse des Schließzylinders darf maximal 3 mm über das Zylinder-Schutzprofil überstehen.



63



64

31. Befestigen Sie den Schließzylinder mit einer Stulpschraube (PH2).



65

↳ SmartHandle AX Advanced fertig montiert.

7. Beschlag demontieren (Schutzbeschlag)

✓ 1,5-mm-Sechskantschlüssel vorhanden.

1. Demontieren Sie den Beschlag in umgekehrter Reihenfolge zur Montage.
2. Lösen Sie dabei das Cover, indem Sie mit dem Spezialwerkzeug das Inlay nach außen biegen.
3. Stecken Sie einen 1,5-mm-Sechskantschlüssel in das Loch der Vierkantaufnahme im Modulträger.



66

4. Biegen Sie den Sechskantschlüssel auf die Seite, auf der sich das Loch befindet und ziehen Sie gleichzeitig am Außendrücker.



67

↳ SmartHandle AX Advanced ist demontiert.

8. Batterien wechseln

**HINWEIS****Funktionsstörungen durch schlechten Kontakt oder unterschiedliche Entladung**

Zu kleine/verunreinigte Kontaktf lächen oder unterschiedliche entladene Batterien können zu Funktionsstörungen führen.

1. Verwenden Sie nur Batterien, die von SimonsVoss freigegeben sind.
2. Berühren Sie die Kontakte der neuen Batterien nicht mit den Händen.
3. Verwenden Sie saubere und fettfreie Handschuhe.
4. Tauschen Sie immer alle Batterien gleichzeitig aus.

✓ Spezialwerkzeug vorhanden.

✓ Handschuhe vorhanden.

1. Stecken Sie das Spezialwerkzeug in das Cover-Inlay der Elektronikseite.



68

2. Biegen Sie mit dem Spezialwerkzeug das Cover-Inlay vorsichtig auf.



69

3. Schieben Sie das Cover nach unten.



70

↳ Cover entriegelt.

4. Nehmen Sie das Cover ab.



71

5. Haken Sie mit dem Spezialwerkzeug die Klammer des Batteriemoduls aus.



72

6. Nehmen Sie das Batteriemodul ab.



73

7. Haken Sie mit dem Spezialwerkzeug die Batterie-Klammer aus.



74

8. Entnehmen Sie die oberen Batterien.



75

9. Biegen Sie die Zwischenfeder vorsichtig zur Seite.

10. Entnehmen Sie die unteren Batterien.



76

11. Setzen Sie zwei neue Batterien mit sich berührenden Pluspolen ein (Typ CR2450).



77

↳ Zwischenfeder sichtbar oberhalb der unteren Batterien.

12. Setzen Sie zwei neue Batterien mit sich berührenden Pluspolen ein (Typ CR2450).



78

13. Haken Sie die Batterie-Klammer wieder ein.



79

14. Setzen Sie das Batteriemodul wieder in den Modulträger ein.



80

15. Haken Sie mit dem Spezialwerkzeug die Klammer des Batteriemoduls wieder ein.



81

↳ SmartHandle AX Advanced piept dreimal.

16. Setzen Sie das Cover oben auf der Fixierplatte an.



82

17. Klappen Sie das Cover nach unten zu.



83

18. Drücken Sie das Cover gegen die Tür und schieben Sie es gleichzeitig nach oben.



84

↳ Cover rastet ein.

19. Drücken Sie das Inlay fest.



85

↳ Batterien sind gewechselt.

9. Technische Daten

Temperaturbereich (Betrieb)	-25 °C bis +60 °C
Batterietyp	4 × CR2450 3V Lithium
Batteriehersteller	<ul style="list-style-type: none"> ■ Murata ■ Panasonic ■ Varta
IP-Schutzklasse	Bis zu IP66 (WP-Variante)

Funkemissionen

15,24 kHz - 72,03 kHz Nur für Artikelnummern: SV-S3.*AM.G2*, SV-S3.*A.G2*, SJ-S3.*LN*	10 dBµA/m (3 m Entfernung)
--	----------------------------

13,560006 MHz - 13,560780 MHz Nur für Artikelnummern: SV-S3.*AM.G2*, SV-S3.*A.G2*, SI-S3.*M.WO*, SI-S3.*LN*	1,04 dBµA/m (3 m Entfernung)
868,000 MHz - 868,600 MHz / 869,700 MHz - 870,000 MHz Nur für Artikelnummern: SI-S3.*M.WO*, SI-S3.*LN*	<25 mW ERP
2402 MHz - 2480 MHz Nur für Artikelnummern: SV-S3.*AM.G2*, SV-S3.*A.G2*, SI-S3.*M.WO*, SI-S3.*LN*	2,5 mW

10. Konformitätserklärung

Hiermit erklärt die SimonsVoss Technologies GmbH, dass die Artikel (SI-S3.*M.VCN*, SV-S3.*M.G2*, SV-S3.*AM.G2*, SV-S3.*A.G2*, SI-S3.*M.WO*, SI-S3.*LN*) folgenden Richtlinien entsprechen:

- 2014/53/EU -Funkanlagen-
bzw. für UK: Rechtsverordnung 2017 Nr. 1206 -Funkanlagen-
- 2011/65/EU -RoHS-
bzw. für UK: Rechtsverordnung 2012 Nr. 3032 -RoHS-



Der vollständige Text der EU-Konformitätserklärung ist unter der folgenden Internetadresse verfügbar: www.simons-voss.com/de/zertifikate.html.
Der vollständige Text der UK-Konformitätserklärung ist unter der folgenden Internetadresse verfügbar: www.simons-voss.com/de/zertifikate.html.

11. Hilfe und weitere Informationen

Infomaterial/Dokumente

<https://www.simons-voss.com/de/dokumente.html>
<https://www.smartintego.com/de/home/infocenter/dokumentation>

Konformitätserklärungen und Zertifikate

<https://www.simons-voss.com/de/zertifikate.html>

Informationen zur Entsorgung

- Entsorgen Sie das Gerät (SI-S3.*M.VCN*, SV-S3.*M.G2*, SV-S3.*AM.G2*, SV-S3.*A.G2*, SI-S3.*M.WO*, SI-S3.*LN*) nicht mit dem Hausmüll, sondern gemäß der europäischen Richtlinie 2012/19/EU bei einer kommunalen Sammelstelle für Elektro-Sonderabfälle.
- Recyceln Sie defekte oder verbrauchte Batterien gemäß der europäischen Richtlinie 2006/66/EG.
- Beachten Sie örtliche Bestimmungen zur getrennten Entsorgung von Batterien.
- Führen Sie die Verpackung einer umweltgerechten Wiederverwertung zu.



Technischer Support

+49 (0) 89 / 99 228 333

E-Mail

support-simonsvoss@allegion.com
si-support-simonsvoss@allegion.com

FAQ

<https://faq.simons-voss.com/otrs/public.pl>

SimonsVoss Technologies GmbH, Feringastr. 4, D-85774 Unterfoehring, Deutschland

Contents

1.	General safety instructions	36
2.	Product-specific safety instructions	36
3.	Scope of delivery	36
4.	Design	37
5.	Prepare door (drilling template)	37
6.	Installing the fitting	37
7.	Removing the fitting (protective fitting)	38
8.	Replacing the batteries.....	39
9.	Technical data	39
10.	Declaration of conformity.....	39
11.	Help and other information	39

1. General safety instructions

Signal word: Possible immediate effects of non-compliance

WARNING: Death or serious injury (possible, but unlikely), CAUTION: Minor injury, IMPORTANT: Property damage or malfunction, NOTE: Low or none



WARNING

Blocked access

Access through a door may stay blocked due to incorrectly fitted and/or incorrectly programmed components. SimonsVoss Technologies GmbH is not liable for the consequences of blocked access such as access to injured or endangered persons, material damage or other damage!

Blocked access through manipulation of the product

If you change the product on your own, malfunctions can occur and access through a door can be blocked.

- Modify the product only when needed and only in the manner described in the documentation.

Do not swallow battery. Danger of burns from hazardous substances

This product contains lithium button cell batteries. Swallowing the button cell battery, in can result in severe internal burns leading to death in as little as two hours.

1. Keep new and used batteries away from children.
2. If the battery compartment does not close securely, cease using the product and keep it away from children.
3. If you think batteries have been swallowed or are in any part of the body, seek medical attention immediately.

Risk of explosion due to incorrect battery type

Inserting the wrong type of battery can cause an explosion.

- Only use the batteries specified in the technical data.



CAUTION

Fire hazard posed by batteries

The batteries used may pose a fire or burn hazard if handled incorrectly.

1. Do not try to charge, open, heat or burn the batteries.
2. Do not short-circuit the batteries.

IMPORTANT

Damage resulting from electrostatic discharge (ESD) when enclosure is open

This product contains electronic components that may be damaged by electrostatic discharges.

1. Use ESD-compliant working materials (e.g. Grounding strap).
2. Ground yourself before carrying out any work that could bring you into contact with the electronics. For this purpose, touch earthed metallic surfaces (e.g. door frames, water pipes or heating valves).

Damage resulting from liquids

This product contains electronic and/or mechanic components that may be damaged by liquids of any kind.

- Keep liquids away from the electronics.

Damage resulting from aggressive cleaning agents

The surface of this product may be damaged as a result of the use of unsuitable cleaning agents.

- Only use cleaning agents that are suitable for plastic or metal surfaces.

Damage as a result of mechanical impact

This product contains electronic components that may be damaged by mechanical impacts of any kind.

1. Avoid touching the electronics.
2. Avoid other mechanical influences on the electronics.

Damage due to polarity reversal

This product contains electronic components that may be damaged by reverse polarity of the power source.

- Do not reverse the polarity of the voltage source (batteries or mains adapters).

Operational malfunction due to radio interference

This product may be affected by electromagnetic or magnetic interference.

- Do not mount or place the product directly next to devices that could cause electromagnetic or magnetic interference (switching power supplies!).

Communication interference due to metallic surfaces

This product communicates wirelessly. Metallic surfaces can greatly reduce the range of the product.

- Do not mount or place the product on or near metallic surfaces.



NOTE

Intended use

SimonsVoss-products are designed exclusively for opening and closing doors and similar objects.

- Do not use SimonsVoss products for any other purposes.

Malfunctions due to poor contact or different discharge

Contact surfaces that are too small/contaminated or different discharged batteries can lead to malfunctions.

1. Only use batteries that are approved by SimonsVoss.
2. Do not touch the contacts of the new batteries with your hands.
3. Use clean and grease-free gloves.
4. Always replace all batteries at the same time.

Different times for G2 locks

The internal time unit of the G2 locks has a technical tolerance of up to ± 15 minutes per year.

Qualifications required

The installation and commissioning requires specialized knowledge.

- Only trained personnel may install and commission the product.

Modifications or further technical developments cannot be excluded and may be implemented without notice.

The German language version is the original instruction manual. Other languages (drafting in the contract language) are translations of the original instructions.

Read and follow all installation, installation, and commissioning instructions. Pass these instructions and any maintenance instructions to the user.

2. Product-specific safety instructions

IMPORTANT

Difficult installation due to threaded sleeves being pressed out

The threaded sleeves in the fitting are installed using a press fit. If you apply excessive pressure when screwing the fitting onto the fixing plate, this can lead to the threaded sleeves slipping out of the fitting.

1. Do not press on the screws when fastening the module support into place.
2. Place a finger on the ends of the threaded sleeves to hold them in place while screwing.

3. Scope of delivery

- SmartHandle AX Advanced Security fitting

- Special tool

- Quick guide

Depending on version:











- Adapter set, 7 mm spindle

- Adapter sleeve, 8.5 mm spindle
- Adapter sleeve, 10 mm spindle



4. Design



5. Prepare door (drilling template)

- ✓ Pin or scriber at hand.
 - ✓ Drill at hand.
 - ✓ Suitable drill available (\varnothing 13 mm).
 - ✓ PH2 screwdriver at hand.
1. Insert the spindle into the mortise lock.
 
 2. Place the drilling template on the spindle.
 
 3. Align the drill template vertically using the printed scale.
 4. Mark the drill holes with mark 1.
 
 5. Remove the drilling template and rotate it 180 degrees.
 
 6. Place the drilling template on the spindle.
 
 7. Align the drill template vertically using the printed scale.
 8. Mark the drill hole with mark 2.
 
 9. Remove the drilling template and spindle.
 

 10. Remove the mortise lock.
 
 11. Drill the required holes.
 
 12. Fit the mortise lock.
 

6. Installing the fitting

- ✓ Door pre-drilled.
 - ✓ PH2 screwdriver at hand.
 - ✓ TX15 screwdriver at hand.
 - ✓ Have an SW6 hex slotted-head screwdriver ready.
 - ✓ Have an SW5 hex slotted-head screwdriver ready.
 - ✓ Caliper gauge at hand.
1. Insert the spindle protective tube and the sleeve nuts into the fixing plate (short sleeve nut in the middle).
 
 2. For 7 mm spindle: Insert the adapter shoe into the spindle mount on the module support.
 
 3. Insert the module support into the fastening plate.
 

IMPORTANT

Damage to the sleeve nuts due to improper insertion

If the sleeve nut tabs are not located in the recesses, they can be damaged during further installation. In such cases, the sleeve nut can rotate unintentionally, which makes installation/removal difficult.

- Ensure that the sleeve nut tabs are located in the recesses.



4. Slide the module support upwards.



↳ Module support snaps into place.

5. Fasten the module support to the fixing plate (PH2) with the 16 mm screws.



6. Measure the door thickness.



Size	Door thickness (mm)	Screws (M8)	Screw (M6)
S	39 – <45	25	50
S	45 – <47.5	25	55
S	47.5 – <50	35	55
S	50 – <55	35	60
M	54 – <60	40	65
M	60 – <65	40	70
M	65 – <70	50	75
M	70 – <75	50	80
L	74 – <80	60	85
L	80 – <85	60	90
L	85 – <90	70	95
L	90 – <95	70	100

7. Determine what screws are required for the door thickness measured.



8. Insert the module support with the fastening plate into the outer side of the door.



IMPORTANT

Damage to the sleeve nuts due to improper insertion

If the sleeve nut tabs are not located in the recesses, they can be damaged during further installation. In such cases, the sleeve nut can rotate unintentionally, which makes installation/removal difficult.

- Ensure that the sleeve nut tabs are located in the recesses.



9. Screw the washers and the inner plate firmly onto the module support (SW6 short screws, SW5 long screw in the centre).



10. For 8.5 mm and 10 mm spindle: slide the adapter sleeve into the centre of the spindle. Use a punch and hammer to make an indent in the adapter sleeve to prevent it from slipping.



11. Measure the total length of the spindle.



12. Locate the inside of the spindle (four-edge end up to the centre of the first groove = 26 mm).

13. Use the table to determine the position of the O-ring.



Area	Door thickness (mm)	Spindle length (mm)	Ring position
S	39 - <43	104	2
S	39 - <43	114	4
S	43 - <48	104	1
S	43 - <48	114	3
S	48 - <53	114	2
S	53 - 55	114	1
M	54 - <58	124	3
M	54 - <58	134	5
M	58 - <63	124	2
M	58 - <63	134	4
M	63 - <68	124	1
M	63 - <68	134	3
M	66 - <73	134	2
M	73 - 75	134	1
L	74 - <78	144	3
L	74 - <78	154	5
L	78 - <83	144	2
L	78 - <83	154	4
L	83 - <88	144	1
L	83 - <88	154	3
L	88 - <93	154	2
L	93 - 95	154	1

14. Slide the O-ring onto the calculated groove.



15. Insert the spindle into the door with the ring-free side as far as it will go.



16. Insert the filling profile onto the inner fixing plate.



17. For 7 mm spindle: Place the adapter sleeve in the inside handle in such a way that the recess faces the grub screw.



18. Determine the required direction of rotation for your inside handle.

19. Insert the spring element appropriately.



20. Place the inside handle unit on the spindle.



21. Use the 12 mm screws to fasten the inner handle unit onto the fixing plate (PH2).



22. Place the cover on top of the fastening plate.



23. Fold down the cover.



24. Slide the cover upwards.



25. Press the inlay into place.



26. Fit the outside handle.



27. Use the grub screw to fasten the outer handle (TX15) into position.



28. Use the grub screw to fasten the inner handle (TX15) into position.



29. Fit the cover for the inner side as well.



30. Insert a locking cylinder.



NOTE

Requirements for the security fitting approval

The approval for the SmartHandle AX Advanced is subject to conditions:

- Observe the locking cylinder's protection class.
- The locking cylinder's housing may protrude a maximum of 3 mm above the cylinder protection profile.



31. Fasten the locking cylinder with a fastening screw (PH2).



- SmartHandle AX Advanced fully installed.

7. Removing the fitting (protective fitting)

- 1.5 mm hexagonal wrench available.

- Remove the fitting in the reverse order to installation.
- Loosen the cover by bending the inlay outwards using the special tool.
- Insert a 1.5 mm hex key into the hole in the spindle mount in the module support.



4. Bend the hex key to the side where the hole is located while pulling on the outside handle.



- ↳ SmartHandle AX Advanced is now removed.

8. Replacing the batteries



NOTE

Malfunctions due to poor contact or different discharge

Contact surfaces that are too small/contaminated or different discharged batteries can lead to malfunctions.

1. Only use batteries that are approved by SimonsVoss.
2. Do not touch the contacts of the new batteries with your hands.
3. Use clean and grease-free gloves.
4. Always replace all batteries at the same time.

- ✓ Special tool at hand.
- ✓ Gloves at hand.

1. Insert the special tool into the cover inlay on the electronics side.



2. Use the special tool to carefully bend the cover inlay upwards.



3. Slide the cover downwards.



- ↳ Cover unlocked.

4. Remove the cover.



5. Use the special tool to detach the battery module clip.



6. Remove the battery module.



7. Use the special tool to detach the battery clip.



8. Remove the upper batteries.



9. Carefully bend the intermediate spring to one side.

10. Remove the lower batteries.



11. Insert two new batteries with the positive terminals next to each other (type CR2450).



- ↳ Intermediate spring visible above the lower batteries.

12. Insert two new batteries with the positive terminals next to each other (type CR2450).



13. Reattach the battery clip.



14. Put the battery module back into the module support.



15. Use the special tool to reattach the battery module clip.



- ↳ SmartHandle AX Advanced will beep three times.

16. Place the cover on top of the fastening plate.



17. Fold down the cover.



18. Push the cover against the door, sliding it upwards at the same time.



- ↳ Cover snaps into place.

19. Press the inlay into place.



- ↳ Batteries are now replaced.

9. Technical data

Operating temperature range	-25 °C to +60 °C
Battery type	4x CR2450 3V lithium
Battery manufacturer	<ul style="list-style-type: none"> ■ Murata ■ Panasonic ■ Varta
IP protection rating	Up to IP66 (WP variant)

Radio emissions

15.24 kHz - 72.03 kHz Only for item numbers: SV-S3.*AM.G2*, SV-S3.*A.G2*, SI-S3.*LN*	10 dBµA/m (3 m distance)
13.560006 MHz - 13.560780 MHz Only for item numbers: SV-S3.*AM.G2*, SV-S3.*A.G2*, SI-S3.*M.WO*, SI-S3.*LN*	1.04 dBµA/m (3 m distance)
868.000 MHz - 868.600 MHz / 869.700 MHz - 870.000 MHz Only for item numbers: SI-S3.*M.WO*, SI-S3.*LN*	<25 mW ERP
2402 MHz - 2480 MHz Only for item numbers: SV-S3.*AM.G2*, SV-S3.*A.G2*, SI-S3.*M.WO*, SI-S3.*LN*	2.5 mW

10. Declaration of conformity

The company SimonsVoss Technologies GmbH hereby declares that the articles (SI-S3.*M.VCN*, SV-S3.*M.G2*, SV-S3.*AM.G2*, SV-S3.*A.G2*, SI-S3.*M.WO*, SI-S3.*LN*) comply with the following guidelines:

- 2014/53/EU -RED-
or for the UK: UK statutory 2017 No. 1206 -Radio equipment-
- 2011/65/EU -RoHS-
or for the UK: UK statutory 2012 No. 3032 -RoHS-



The full text of the EU Declaration of conformity is available at the following internet address: www.simons-voss.com/en/certificates.html.
The full text of the UK Declaration of conformity is available at the following internet address: www.simons-voss.com/en/certificates.html.

11. Help and other information

Information material/documents

<https://www.simons-voss.com/en/documents.html>

<https://www.smartintego.com/int/home/infocenter/documentation>

Declarations of conformity

<https://www.simons-voss.com/en/certificates.html>

Information on disposal

- Do not dispose the device (SI-S3.*M.VCN*, SV-S3.*M.G2*, SV-S3.*AM.G2*, SV-S3.*A.G2*, SI-S3.*M.WO*, SI-S3.*LN*) in the household waste. Dispose of it at a collection point for electronic waste as per European Directive 2012/19/EU.
- Recycle defective or used batteries in line with European Directive 2006/66/EC.

- Observe local regulations on separate disposal of batteries.
- Take the packaging to an environmentally responsible recycling point.



Technical support

+49 (0) 89 / 99 228 333

Email

support-simonsvoss@allegion.com

si-support-simonsvoss@allegion.com

FAQs

<https://faq.simons-voss.com/otrs/public.pl>

SimonsVoss Technologies GmbH, Feringastr. 4, D-85774 Unterfoehring,
Germany

Tables des matières

1.	Consignes de sécurité générales	42
2.	Consignes de sécurité propres au produit	43
3.	Fourniture	43
4.	Structure.....	43
5.	Préparer la porte (gabarit de perçage).....	43
6.	Monter la garniture.....	43
7.	Démonter la garniture (garniture de protection)	45
8.	Remplacer les piles	45
9.	Caractéristiques techniques	45
10.	Déclaration de conformité.....	46
11.	Aide et autres informations.....	46

1. Consignes de sécurité générales

Mot indicateur: Effets immédiats possibles du non-respect

AVERTISSEMENT: Mort ou blessure grave (possible, mais improbable), PRUDENCE: Blessure légère, ATTENTION: Dommages matériels ou dysfonctionnements, NOTE: Peu ou pas



AVERTISSEMENT

Accès bloqué

Toute erreur de montage et/ou de programmation d'un composant peut bloquer l'accès par une porte. La société SimonsVoss Technologies GmbH décline toute responsabilité quant aux conséquences d'un accès bloqué, par exemple, accès pour les personnes blessées ou en danger, dommages matériels ou autres dommages !

Accès bloqué par la manipulation du produit

Si vous modifiez vous-même le produit, des dysfonctionnements peuvent se produire et l'accès peut être bloqué par une porte.

- Ne changer le produit que lorsque cela est nécessaire et de la manière décrite dans la documentation.

Ne pas saisir la pile. Risque de brûlures dues à des substances dangereuses

Ce produit contient des piles au lithium. En cas d'ingestion de la pile, de graves brûlures internes peuvent se produire sous deux heures et entraîner la mort.

1. Conservez les piles neuves et usagées hors de portée des enfants.
2. Si le compartiment à piles ne ferme pas correctement, cessez d'utiliser le produit et conservez-le hors de portée des enfants.
3. En cas de suspicion d'ingestion des piles ou si celles-ci se trouvent dans une partie quelconque de votre corps, consultez immédiatement un médecin.

Risque d'explosion dû à un type de batterie incorrect

L'insertion d'un mauvais type de batterie peut provoquer une explosion.

- Utilisez uniquement les piles indiquées dans les données techniques.



PRUDENCE

Risque d'incendie dû aux piles

En cas de manipulation impropre, les piles insérées peuvent provoquer un incendie ou des brûlures.

1. Ne jamais essayer de recharger les piles, de les ouvrir, de les chauffer ou de les brûler.
2. Ne pas court-circuiter les piles.

ATTENTION

Endommagement lié à une décharge électrostatique (DES) lorsque le boîtier est ouvert

Ce produit contient des composants électroniques susceptibles d'être endommagés par des décharges électrostatiques.

1. Utilisez du matériel de travail adapté à la DES (par ex. un bracelet de mise à la terre).
2. Reliez-vous à la terre avant de commencer les travaux pendant lesquels vous pouvez être en contact avec le système électronique. Saisissez pour cela des surfaces métalliques mises à la terre (par ex. huisseries de porte, conduites d'eau ou vannes de chauffage).

Endommagement lié à des liquides

Ce produit contient des composants électroniques et/ou mécaniques susceptibles d'être endommagés par tout type de liquide.

- Tenez les liquides à l'écart du système électronique.

Endommagement lié à des nettoyants agressifs

La surface de ce produit peut être endommagée par des nettoyants inappropriés.

- Utilisez exclusivement des nettoyants adaptés aux surfaces plastiques ou métalliques.

Endommagement lié à une action mécanique

Ce produit contient des composants électroniques susceptibles d'être endommagés par une action mécanique quelconque.

1. Évitez de toucher le système électronique.
2. Évitez toute autre action mécanique sur le système électronique.

Endommagement lié à une inversion de polarité

Ce produit contient des composants électroniques susceptibles d'être endommagés par une inversion de polarité de la source de tension.

- N'inversez pas la polarité de la source de tension (piles ou blocs d'alimentation).

Défaillance du fonctionnement liée à une perturbation radioélectrique

Dans certaines circonstances, ce produit peut subir l'influence de perturbations électromagnétiques ou magnétiques.

- Ne montez pas et ne placez pas le produit à proximité immédiate d'appareils pouvant générer des perturbations électromagnétiques ou magnétiques (alimentations à découpage !).

Défaillance de la communication liée à des surfaces métalliques

Ce produit communique sans fil. Les surfaces métalliques peuvent réduire considérablement le rayon d'action du produit.

- Ne montez pas et ne placez pas le produit sur ou à proximité de surfaces métalliques.



NOTE

Utilisation conforme aux dispositions

Les produits SimonsVoss sont exclusivement destinés à l'ouverture et la fermeture de portes et d'objets similaires.

- N'utilisez pas les produits SimonsVoss à d'autres fins.

Horaires différents pour les fermetures G2

L'unité de temps interne des fermetures G2 présente une tolérance technique pouvant atteindre ± 15 minutes par an.

Qualifications requises

L'installation et la mise en service nécessitent des connaissances spécialisées.

- Seul le personnel qualifié peut installer et mettre en service le produit.

Dysfonctionnements dus à un mauvais contact ou à une décharge différente

Des surfaces de contact trop petites/contaminées ou différentes batteries déchargées peuvent entraîner des dysfonctionnements.

1. Utilisez uniquement des piles autorisées par la société SimonsVoss.
2. Ne touchez pas les contacts des piles neuves avec les mains.
3. Utilisez des gants propres et exempts de graisse.
4. Remplacez toujours toutes les piles à la fois.

Les modifications et nouveaux développements techniques ne peuvent pas être exclus et peuvent être mis en œuvre sans préavis.

La version allemande est le manuel d'instruction original. Les autres langues (rédaction dans la langue du contrat) sont des traductions des instructions originales.

Lisez et suivez toutes les instructions d'installation, d'installation et de mise en service. Transmettez ces instructions et toutes les instructions de maintenance à l'utilisateur.

2. Consignes de sécurité propres au produit

ATTENTION

Montage difficile en raison de douilles filetées expulsées

Les douilles filetées dans la garniture sont montées avec un ajustement serré. Une pression excessive lors du vissage de la garniture sur la plaque de fixation peut entraîner le glissement des douilles filetées hors de la garniture.

1. N'appuyez pas sur les vis lors du vissage du support de module.
2. Utilisez un doigt aux extrémités des douilles filetées pour exercer une résistance pendant le serrage.

3. Fourniture

- SmartHandle AX Advanced Garniture de protection
 - Outil spécial
 - Guide abrégé
- Selon la version :
- Kit d'adaptateur Carré de 7 mm
 - Manchon adaptateur Carré de 8,5 mm
 - Manchon adaptateur Carré de 10 mm

4. Structure



5. Préparer la porte (gabarit de perçage)

- ✓ Goupille ou pointe disponible.
- ✓ Perceuse disponible.
- ✓ Foret adapté disponible (\varnothing 13 mm).
- ✓ Tournevis PH2 disponible.

1. Insérez le carré dans la serrure encastrée.



2. Placez le gabarit de perçage sur le carré.



3. Orientez le gabarit de perçage à la verticale au moyen de la graduation imprimée.

4. Marquez les trous de perçage avec le repère 1.



5. Retirez le gabarit de perçage et tournez-le de 180 degrés.



6. Placez le gabarit de perçage sur le carré.



7. Orientez le gabarit de perçage à la verticale au moyen de la graduation imprimée.

8. Marquez le trou de perçage avec le repère 2.



9. Retirez le gabarit de perçage et le carré.



10. Démontez la serrure encastrée.



11. Percez les trous nécessaires.



12. Montez la serrure encastrée.



6. Monter la garniture

- ✓ Porte préperçée.
- ✓ Tournevis PH2 disponible.
- ✓ Tournevis TX15 disponible.
- ✓ Tournevis hexagonal SW6 disponible.
- ✓ Tournevis hexagonal SW5 disponible.
- ✓ Pied à coulisse disponible.

1. Insérez le tube de protection carré et les écrous à douille dans la plaque de fixation (écrou à douille court au milieu).



2. Pour un carré de 7 mm : Placez le dispositif d'adaptation dans le logement carré du support de module.



3. Insérez le support de module dans la plaque de fixation.



ATTENTION

Endommagement des écrous à douille dû à une mise en place incorrecte

Si les ergots des écrous à douille ne sont pas insérés dans les encoches, ils risquent d'être endommagés pendant la suite du montage. Dans ce cas, l'écrou à douille peut tourner et rendre le montage/démontage plus difficile.

- Veillez à ce que les ergots des écrous à douille s'insèrent dans les encoches.



4. Poussez le support de module vers le haut.



↳ Le support de module s'enclenche.

5. Vissez le support de module sur la plaque de fixation au moyen des vis de 16 mm (PH2).



6. Mesurez l'épaisseur de porte.



Zone	Épaisseur de porte (mm)	Vis (M8)	Vis (M6)
S	39 - <45	25	50
S	45 - <47,5	25	55
S	47,5 - <50	35	55
S	50 - <55	35	60
M	54 - <60	40	65
M	60 - <65	40	70
M	65 - <70	50	75
M	70 - <75	50	80
L	74 - <80	60	85
L	80 - <85	60	90
L	85 - <90	70	95
L	90 - <95	70	100

7. Déterminez les vis nécessaires sur la base de l'épaisseur de porte mesurée.





26



27



28



29



30



31



32



33



34



35



36



37



38

8. Insérez le support de module avec la plaque de fixation, côté extérieur de la porte.



39

ATTENTION**Endommagement des écrous à douille dû à une mise en place incorrecte**

Si les ergots des écrous à douille ne sont pas insérés dans les encoches, ils risquent d'être endommagés pendant la suite du montage. Dans ce cas, l'écrou à douille peut tourner et rendre le montage/démontage plus difficile.

- Veillez à ce que les ergots des écrous à douille s'insèrent dans les encoches.



17

9. Vissez les rondelles et la plaque intérieure sur le support de module (vis courtes SW6, vis longue au milieu SW5).



41

10. Pour un carré de 8,5 ou de 10 mm : Poussez le manchon adaptateur au milieu du carré. Réalisez un renforcement dans le manchon adaptateur au moyen d'un poinçon et d'un marteau afin d'éviter qu'il ne glisse.



42



43

11. Mesurez la longueur totale du carré.



44

12. Déterminez le côté intérieur du carré (de la fin du carré au milieu de la rainure = 26 mm).

13. Déterminez la position du joint torique sur la base du tableau.



45

Zone	Épaisseur de porte (mm)	Longueur du carré (mm)	Position de la bague
S	39 - <43	104	2
S	39 - <43	114	4
S	43 - <48	104	1
S	43 - <48	114	3
S	48 - <53	114	2
S	53 - 55	114	1
M	54 - <58	124	3
M	54 - <58	134	5
M	58 - <63	124	2
M	58 - <63	134	4
M	63 - <68	124	1
M	63 - <68	134	3
M	66 - <73	134	2
M	73 - 75	134	1
L	74 - <78	144	3
L	74 - <78	154	5
L	78 - <83	144	2
L	78 - <83	154	4
L	83 - <88	144	1
L	83 - <88	154	3
L	88 - <93	154	2
L	93 - 95	154	1

14. Poussez le joint torique sur la rainure calculée.



46

15. Insérez à fond le carré dans la porte par le côté sans bague.



47

16. Placez le profilé de remplissage sur la plaque de fixation côté intérieur.



48

17. Pour un carré de 7 mm : Placez le manchon adaptateur dans la poignée intérieure de manière à ce que l'évidement soit dirigé vers la vis sans tête.



49

18. Déterminez le sens de rotation souhaité pour votre poignée intérieure.

19. Insérez l'élément de ressort en conséquence.



50



51

20. Placez l'unité de poignée intérieure sur le carré.



52

21. Vissez l'unité de béquille intérieure sur la plaque de fixation au moyen des vis de 12 mm (PH2).



53



54

22. Placez le capot en haut de la plaque de fixation.



55

23. Rabattez le capot vers le bas.



56

24. Poussez le capot vers le haut.







57

25. Appuyez fermement sur l'incrustation.



58

26. Mettez en place la poignée extérieure.  59
27. Vissez la béquille extérieure à l'aide de la vis sans tête (TX15).  60
28. Vissez la béquille intérieure à l'aide de la vis sans tête (TX15).  61
29. Montez également le capot pour le côté intérieur.  62
30. Insérez un cylindre de fermeture.

**NOTE****Conditions d'homologation de la garniture de protection**

L'homologation SmartHandle AX Advanced est soumise aux conditions suivantes :

1. Veillez à la classe de protection du cylindre de fermeture.
2. Le boîtier du cylindre de fermeture ne doit pas dépasser de plus de 3 mm du profilé de protection du cylindre.



63



64

31. Fixez le cylindre de fermeture avec une vis de maintien (PH2).



65

- ↳ Le montage de la SmartHandle AX Advanced est terminé.

7. Démonter la garniture (garniture de protection)

- ✓ Clé à six pans 1,5 mm disponible.

1. Démontez la serrure en procédant comme pour le montage mais dans l'ordre inverse.
2. Pour ce faire, désolidarisez le capot en pliant l'incrustation vers l'extérieur au moyen de l'outil spécial.
3. Insérez une clé à six pans 1,5 mm dans le trou du logement du carré dans le support de module.



66

4. Pliez la clé à six pans du côté où se trouve le trou tout en tirant sur la poignée extérieure.



67

- ↳ La SmartHandle AX Advanced est démontée.

8. Remplacer les piles

**NOTE**

Dysfonctionnements dus à un mauvais contact ou à une décharge différente

Des surfaces de contact trop petites/contaminées ou différentes batteries déchargées peuvent entraîner des dysfonctionnements.

















1. Utilisez uniquement des piles autorisées par la société SimonsVoss.
2. Ne touchez pas les contacts des piles neuves avec les mains.
3. Utilisez des gants propres et exempts de graisse.
4. Remplacez toujours toutes les piles à la fois.

- ✓ Outil spécial disponible.
- ✓ Gants disponible.

1. Insérez l'outil spécial dans l'incrustation du capot du côté électronique.



68

2. Au moyen de l'outil spécial, pliez avec précaution l'incrustation du capot.  69
3. Poussez le capot vers le bas.  70
↳ Le capot se déverrouille.
4. Retirez le capot.  71
5. Au moyen de l'outil spécial, décrochez les clips du module de batterie.  72
6. Retirez le module de piles.  73
7. Au moyen de l'outil spécial, décrochez les clips des piles.  74
8. Retirez les piles du haut.  75
9. Pliez avec précaution le ressort intermédiaire sur le côté.
10. Retirez les piles du bas.  76
11. Insérez deux nouvelles piles avec les pôles plus au contact l'un de l'autre (type CR2450).  77
↳ Ressort intermédiaire visible au-dessus des piles du bas.
12. Insérez deux nouvelles piles avec les pôles plus au contact l'un de l'autre (type CR2450).  78
13. Refermez les clips des piles.  79
14. Réinsérez le module de piles dans le support de module.  80
15. Au moyen de l'outil spécial, refermez les clips du module de batterie.  81
↳ La SmartHandle AX Advanced émet trois bips.
16. Placez le capot en haut de la plaque de fixation.  82
17. Rabattez le capot vers le bas.  83
18. Appuyez le capot contre la porte tout en le faisant glisser vers le haut.  84
↳ Le capot s'enclenche.
19. Appuyez fermement sur l'incrustation.  85
↳ Les piles sont changées.

9. Caractéristiques techniques

Plage de températures (fonctionnement)	de -25 °C à +60 °C
Type de piles	4 x piles CR2450 3V Lithium
Fabricant des piles	<ul style="list-style-type: none"> ■ Murata ■ Panasonic ■ Varta
Classe de protection IP	Jusqu'à IP66 (version WP)

Émissions de radio

15,24 kHz - 72,03 kHz Seulement pour les numéros d'article : SV-S3.*AM.G2*, SV-S3.*A.G2*, SI-S3.*LN*	10 dBµA/m (3 m distance)
13,560006 MHz - 13,560780 MHz Seulement pour les numéros d'article : SV-S3.*AM.G2*, SV-S3.*A.G2*, SI-S3.*M.WO*, SI-S3.*LN*	1,04 dBµA/m (3 m distance)
868,000 MHz - 868,600 MHz / 869,700 MHz - 870,000 MHz Seulement pour les numéros d'article : SI-S3.*M.WO*, SI-S3.*LN*	<25 mW ERP
2402 MHz - 2480 MHz Seulement pour les numéros d'article : SV-S3.*AM.G2*, SV-S3.*A.G2*, SI-S3.*M.WO*, SI-S3.*LN*	2,5 mW

10. Déclaration de conformité

La société SimonsVoss Technologies GmbH déclare par la présente que les articles (SI-S3.*M.VCN*, SV-S3.*M.G2*, SV-S3.*AM.G2*, SV-S3.*A.G2*, SI-S3.*M.WO*, SI-S3.*LN*) est conforme aux directives suivantes:

- 2014/53/EU -RED-
ou pour UK : UK statutory 2017 No. 1206 -Radio equipment-
(équipement radio)
- 2011/65/UE -RoHS-
ou pour UK : UK statutory 2012 No. 3032 -RoHS-



Le texte intégral de la déclaration de conformité CE est disponible à l'adresse Internet suivante : www.simons-voss.com/fr/certificats.html.
Le texte intégral de la déclaration de conformité UK est disponible à l'adresse Internet suivante : www.simons-voss.com/fr/certificats.html.

11. Aide et autres informations

Documentation/documents

<https://www.simons-voss.com/fr/documents.html>
<https://www.smartintego.com/fr/home/infocenter/documentations>

Déclarations de conformité

<https://www.simons-voss.com/fr/certificats.html>

Informations sur l'élimination

- Ne jetez pas l'appareil (SI-S3.*M.VCN*, SV-S3.*M.G2*, SV-S3.*AM.G2*, SV-S3.*A.G2*, SI-S3.*M.WO*, SI-S3.*LN*) avec vos ordures ménagères mais dans un point de collecte communal pour appareils électriques et appareils spéciaux conformément à la directive européenne 2012/19/UE.
- Recyclez les piles défectueuses ou usées conformément à la directive européenne 2006/66/CE.
- Veuillez tenir compte des dispositions locales applicables concernant la collecte séparée des piles.
- Recyclez l'emballage d'une manière écologique.



Assistance technique

+49 (0) 89 / 99 228 333

E-Mail

support-simonsvoss@allegion.com
si-support-simonsvoss@allegion.com

FAQ

<https://faq.simons-voss.com/otrs/public.pl>

SimonsVoss Technologies GmbH, Feringastr. 4, D-85774 Unterfoehring, Allemagne

Inhoudsopgave

1.	Algemene veiligheidsinstructies	48
2.	Specifieke veiligheidsinstructies per product	48
3.	Leveromvang	49
4.	Opbouw	49
5.	Deur voorbereiden (boormal).....	49
6.	Beslag monteren.....	49
7.	Beslag demonteren (veiligheidsbeslag)	51
8.	Batterijen vervangen.....	51
9.	Technische gegevens.....	51
10.	Verklaring van overeenstemming	52
11.	Hulp en verdere informatie	52

1. Algemene veiligheidsinstructies

Signaalwoord: *Mogelijke onmiddellijke gevolgen van niet-naleving*
WAARSCHUWING: Dood of ernstig letsel (mogelijk, maar onwaarschijnlijk).
VOORZICHTIG: Lichte letsel, LET OP: Materiele schade of storing, OPMERKING: Laag of nee



WAARSCHUWING

Geblokkeerde toegang

Door foutief geïnstalleerde en/of geprogrammeerde componenten kan de doorgang door een deur geblokkeerd blijven. Voor gevolgen van een geblokkeerde toegang tot gewonden of personen in gevaar, materiële of andere schade, is SimonsVoss Technologies GmbH niet aansprakelijk.

Geblokkeerde toegang als gevolg van manipulatie van het product

Als u het product zelf wijzigt, kunnen er storingen optreden en kan de toegang worden geblokkeerd door een deur.

- Vervang het product alleen wanneer dat nodig is en op de manier die in de documentatie wordt beschreven.

Batterijen niet inslikken. Verbrandingsgevaar door gevaarlijke stoffen

Dit product bevat lithium-knoopcellen. Als de knoopcel wordt ingeslikt, kunnen ernstige inwendige brandwonden optreden die binnen slechts twee uur de dood veroorzaken.

1. Houd nieuwe en gebruikte batterijen buiten bereik van kinderen.
2. Als het batterijvak niet goed sluit, mag u het product niet meer gebruiken en moet u het uit de buurt van kinderen houden.
3. Als u denkt dat batterijen zijn ingeslikt of in een ander lichaamsdeel terecht zijn gekomen, moet u onmiddellijk medische hulp inroepen.

Explosiegevaar door verkeerd type batterij

Het plaatsen van het verkeerde type batterij kan een explosie veroorzaken.

- Gebruik alleen de in de technische gegevens vermelde batterijen.



VOORZICHTIG

Brandgevaar door batterijen

De gebruikte batterijen kunnen bij verkeerde behandeling tot brand- of verbrandingsgevaar leiden.

1. Probeer niet de batterijen op te laden, open te maken, te verwarmen of te verbranden.
2. U mag de batterijen evenmin kortsluiten.

LET OP

Schade door elektrostatische ontlading (ESD) wanneer de behuizing open is

Dit product heeft elektronische componenten die kunnen worden beschadigd door een elektrostatische ontlading.

1. Maak gebruik van ESD-conforme materialen (bijv. aardingsarmband).
2. Zorg dat u geaard bent voor werkzaamheden waarbij u met de elektronica in contact kunt komen. Gebruik hiervoor geaarde metalen oppervlakken (bijv. Deurposten, waterleidingen of verwarmingsbuizen).

Beschadiging door vloeistoffen

Dit product heeft elektronische en/of mechanische componenten die kunnen worden beschadigd door elk type vloeistof.

- Houd vloeistoffen uit de buurt van de elektronica.

Beschadiging door bijtende reinigingsmiddelen

Het oppervlak van dit product kan worden beschadigd door ongeschikte reinigingsmiddelen.

- Maak uitsluitend gebruik van reinigingsmiddelen die geschikt zijn voor kunststof of metalen oppervlakken.

Beschadiging door mechanische impact

Dit product heeft elektronische componenten die kunnen worden beschadigd door elk type mechanische impact.

1. Vermijd dat u de elektronica aanraakt.
2. Vermijd ook andere mechanische impact op de elektronica.

Beschadiging door verwisseling van de polariteit

Dit product bevat elektronische componenten die door verwisseling van de polariteit van de voedingsbron beschadigd kunnen worden.

- Vervissel de polariteit van de voedingsbron niet (batterijen of netadapters).

Storing van het gebruik door verbroken verbinding

Dit product kan onder bepaalde omstandigheden beïnvloed worden door elektromagnetische of magnetische storingen.

- Monteer of plaats het product niet direct in de buurt van apparaten die elektromagnetische of magnetische storingen kunnen veroorzaken (stroomschakelaars!).

Storing van de communicatie door metalen oppervlakken

Dit product communiceert draadloos. Metalen oppervlakken kunnen het zendbereik van het product aanzienlijk verminderen.

- Monteer of plaats het product niet op of in de buurt van metalen oppervlakken.



OPMERKING

Beoogd gebruik

SimonsVoss-producten zijn uitsluitend bedoeld voor het openen en sluiten van deuren en vergelijkbare voorwerpen.

- Gebruik SimonsVoss-producten niet voor andere doeleinden.

Storingen door slecht contact of verschillende ontladingen

Contactoppervlakken die te klein/vervuld zijn of verschillende ontladen accus' kunnen leiden tot storingen.

1. Gebruik alleen batterijen die zijn vrijgegeven door SimonsVoss.
2. Raak de contacten van de nieuwe batterijen niet met de handen aan.
3. Gebruik schone, vetvrije handschoenen.
4. Vervang daarom alle batterijen tegelijk.

Afwijkende tijden bij G2-sluitelementen

De interne tijdeenheden van de G2-sluitelementen heeft een technisch bepaalde tolerantie van max. ± 15 minuten per jaar.

Kwalificaties vereist

De installatie en inbedrijfstelling vereist gespecialiseerde kennis. Alleen getraind personeel mag het product installeren en in bedrijf stellen.

Aanpassingen of nieuwe technische ontwikkelingen kunnen niet uitgesloten worden en worden gerealiseerd zonder aankondiging.

De Duitse taalversie is de originele handleiding. Andere talen (opstellen in de contracttaal) zijn vertalingen van de originele instructies.

Lees en volg alle installatie-, installatie- en inbedrijfstellingsinstructies. Geef deze instructies en eventuele onderhoudsinstructies door aan de gebruiker.

2. Specifieke veiligheidsinstructies per product

LET OP

Moelijke montage door naar buiten gedrukte schroefdraadhuizen

De schroefdraadhuizen in het beslag zijn met een perspassing gemonteerd. Overmatige druk bij het vastschroeven van het beslag op de bevestigingsplaat kan ertoe leiden dat de schroefdraadhuizen uit het beslag glijden.

1. Druk bij het vastschroeven van de moduledrager niet op de schroeven.
2. Houd de uiteinden van de schroefdraadhuizen met een vinger tegen tijdens het vastschroeven.

3. Leveromvang

- SmartHandle AX Advanced Veiligheidsbeslag
 - Speciaal gereedschap
 - Korte handleiding
- Afhankelijk van de variant:
- adapterset 7 mm vierkant
 - adapterhuls 8,5 mm vierkant
 - adapterhuls 10 mm vierkant

4. Opbouw



5. Deur voorbereiden (boormal)

- ✓ Pen of kraspen beschikbaar.
 - ✓ een boormachine beschikbaar houden.
 - ✓ Geschikte boor aanwezig (Ø 13 mm).
 - ✓ PH2-schroevendraaier beschikbaar.
1. Steek het vierkant in het insteekslot.
 
 2. Plaats de boormal op het vierkant.
 
 3. Lijn de boormal verticaal uit met behulp van de opgedrukte schaalverdeling.
 4. Markeer de boorgaten met markering 1.
 
 5. Verwijder de boormal en draai deze 180 graden.
 
 6. Plaats de boormal op het vierkant.
 
 7. Lijn de boormal verticaal uit met behulp van de opgedrukte schaalverdeling.
 8. Markeer het boorgat met de markering 2.
 
 9. Neem de boormal en het vierkant weg.
 
 10. Demonteer het insteekslot.
 
 11. Boor de benodigde gaten.
 
 12. Bouw het insteekslot in.
 
 13.
 

6. Beslag monteren

- ✓ Deur voorgeboord.
 - ✓ PH2-schroevendraaier beschikbaar.
 - ✓ TX15-schroevendraaier beschikbaar.
 - ✓ SW6-inbusschroevendraaier beschikbaar.
 - ✓ SW5-inbusschroevendraaier beschikbaar.
 - ✓ Remklauwmeter beschikbaar.
1. Plaats het beschermhuisje voor de vierkantstift en de hulsmoeren in de bevestigingsplaat (korte hulsmoer in het midden).
 

2. Voor 7 mm vierkant: zet de adapterschoen in de vierkante uitsparing van de moduledrager.



3. Steek de moduledrager in de bevestigingsplaat.



LET OP

Beschadiging van de hulsmoeren door ondeskundig aanbrengen

Als de nokken van de hulsmoeren niet in de uitsparingen zitten, kunnen ze tijdens de verdere montage beschadigd raken. In dit geval kan de hulsmoer meedraaien en wordt de montage/demontage bemoeilijkt.

- Let erop dat de nokken van de hulsmoeren correct in de uitsparingen zitten.



4. Schuif de moduledrager omhoog.



↳ De moduledrager klikt vast.

5. Schroef de moduledrager met de schroeven van 12 mm vast op de bevestigingsplaat (PH2).



6. Meet de deurdikte.



Bereik	Deurdikte (mm)	Schroeven (M8)	Schroef (M6)
S	39 - <45	25	50
S	45 - <47,5	25	55
S	47,5 - <50	35	55
S	50 - <55	35	60
M	54 - <60	40	65
M	60 - <65	40	70
M	65 - <70	50	75
M	70 - <75	50	80
L	74 - <80	60	85
L	80 - <85	60	90
L	85 - <90	70	95
L	90 - <95	70	100

7. Bepaal aan de hand van de gemeten deurdikte welke schroeven er nodig zijn.





34



35



36



37



38

8. Steek de moduledrager met de bevestigingsplaat in de buitenkant van de deur.



39

LET OP**Beschadiging van de hulsmoeren door ondeskundig aanbrengen**

Als de nokken van de hulsmoeren niet in de uitsparingen zitten, kunnen ze tijdens de verdere montage beschadigd raken. In dit geval kan de hulsmoer meedraaien en wordt de montage/demontage bemoeilijkt.

- Let erop dat de nokken van de hulsmoeren correct in de uitsparingen zitten.



17

9. Schroef de sluitringen en de binnenplaat aan de moduledrager vast (korte schroeven SW6, lange schroef in het midden SW5).



41

10. Voor 8,5 mm en 10 mm vierkant: schuif de adapterhuls in het midden van het vierkant. Maak met een centerpons en een hamer een verdiept punt in de adapterhuls om verschuiven te voorkomen.



42



43

11. Meet de totale lengte van de vierkantstift.



44

12. Bepaal de binnenkant van de vierkantstift (uiteinde tot het midden van de eerste groef = 26 mm).

13. Bepaal de positie van de O-ring met behulp van de tabel.



45

Bereik	Deurdikte (mm)	Lengte vierkantstift (mm)	Ringpositie
S	39 - <43	104	2
S	39 - <43	114	4
S	43 - <48	104	1
S	43 - <48	114	3
S	48 - <53	114	2
S	53 - 55	114	1
M	54 - <58	124	3
M	54 - <58	134	5
M	58 - <63	124	2
M	58 - <63	134	4
M	63 - <68	124	1
M	63 - <68	134	3
M	66 - <73	134	2
M	73 - 75	134	1
L	74 - <78	144	3
L	74 - <78	154	5
L	78 - <83	144	2
L	78 - <83	154	4
L	83 - <88	144	1
L	83 - <88	154	3
L	88 - <93	154	2
L	93 - 95	154	1

14. Schuif de O-ring op de berekende groef.



46

15. Steek het vierkant met de kant zonder ring tot de aanslag in de deur.



47

16. Plaats het vulprofiel op de grotere bevestigingsplaat aan de binnenkant.



48

17. Voor 7 mm vierkant: breng de adapterhuls zodanig aan in de binnendeurkruk dat de uitsparing naar de stiftap wijst.



49

18. Bepaal de gewenste draairichting van uw binnendeurkruk.

19. Breng het veerelement dienovereenkomstig aan.



50



51

20. Steek de binnendeurkruk op het vierkant.



52

21. Schroef met de schroeven van 12 mm de eenheid van de binnendeurkruk op de bevestigingsplaat (PH2).



53



54

22. zet de cover bovenop de bevestigingsplaat.



55

23. Klap de cover naar beneden dicht.



56

24. Schuif de cover omhoog.







57

25. Druk de inlay vast.



58

26. Steek de buitendeurkruk erop.
 59
27. Schroef de buitendeurkruk vast met de stifttap (TX15).
 60
28. Schroef de binnendeurkruk vast met de stifttap (TX15).
 61
29. Monteer ook de cover voor de binnenzijde.
 62
30. Plaats een cilinder.

**OPMERKING****Voorwaarden van de toelating voor veiligheidsbeslag**

De toelating van de SmartHandle AX Advanced is gebonden aan voorwaarden:

1. Let op de beschermingsklasse van de cilinder.
2. De behuizing van de cilinder mag maximaal 3 mm uitsteken boven het cilinderbeschermingsprofiel.



63



64

31. Bevestig de cilinder met een stiftschroef (PH2).



65

↳ SmartHandle AX Advanced montage afgerond.

7. Beslag demonteren (veiligheidsbeslag)

✓ 1,5 mm inbussleutel beschikbaar.

1. Demonteer het beslag in omgekeerde volgorde van de montage.
2. Maak daarbij de cover los door met het speciale gereedschap de inlay naar buiten te buigen.
3. Steek een inbussleutel van 1,5 mm in het gat van de opname voor de vierkantstift in de moduledrager.



66

4. Buig de inbussleutel naar de zijde waar het gat zich bevindt en trek tegelijkertijd aan de buitendeurkruk.



67

↳ SmartHandle AX Advanced is gemonteerd.

8. Batterijen vervangen

**OPMERKING****Storingen door slecht contact of verschillende ontladingen**

Contactoppervlakken die te klein/vervuld zijn of verschillende ontladen accu's kunnen leiden tot storingen.

1. Gebruik alleen batterijen die zijn vrijgegeven door SimonsVoss.
2. Raak de contacten van de nieuwe batterijen niet met de handen aan.
3. Gebruik schone, vetvrije handschoenen.
4. Vervang daarom alle batterijen tegelijk.

✓ Speciaal gereedschap beschikbaar.

✓ Handschoenen beschikbaar.

1. Steek het speciale gereedschap in de cover-inlay aan de elektronicazijde.



68

2. Buig de coverinlay behoedzaam open met het speciale gereedschap.



69

3. Schuif de cover naar beneden.



70

↳ Cover ontgrendeld.

4. Neem de cover weg.



71

5. Haak met het speciale gereedschap de klem van de batterijmodule los.



72

6. Neem de batterijmodule weg.



73

7. Maak de batterijklem los met het speciale gereedschap.



74

8. Neem de bovenste batterijen uit.



75

9. Buig de tussenveer behoedzaam opzij.

10. Neem nu de onderste batterijen uit.



76

11. Zet twee nieuwe batterijen in met de pluspolen tegen elkaar (type CR2450).



77

↳ De tussenveer is zichtbaar boven de onderste batterijen.

12. Zet twee nieuwe batterijen in met de pluspolen tegen elkaar (type CR2450).



78

13. Haak de batterijklem weer vast.



79

14. Breng de batterijmodule weer aan in de moduledrager.



80

15. Haak met het speciale gereedschap de klem van de batterijmodule weer vast.



81

↳ SmartHandle AX Advanced piept drie keer.

16. zet de cover bovenop de bevestigingsplaat.



82

17. Klap de cover naar beneden dicht.



83

18. Duw de cover tegen de deur en schuif hem tegelijkertijd omhoog.



84

↳ De cover klikt vast.

19. Druk de inlay vast.



85

↳ De batterijen zijn vervangen.

9. Technische gegevens

Temperatuurbereik (bedrijf)	-25°C tot +60°C
Soort batterij	4x CR2450 3V lithium
Batterijmerk	<ul style="list-style-type: none"> ■ Murata ■ Panasonic ■ Varta
IP-beschermingsklasse	Tot IP66 (WP-variant)

Radio-emissies

15,24 kHz - 72,03 kHz Alleen voor artikelnummers: SV-S3.*AM.G2*, SV-S3.*A.G2*, SI-S3.*LN*	10 dBµA/m (3 m afstand)
--	-------------------------

13.560006 MHz - 13.560780 MHz Alleen voor artikelnummers: SV-S3.*AM.G2*, SV-S3.*A.G2*, SI-S3.*M.WO*, SI-S3.*LN*	1,04 dBµA/m (3 m afstand)
868.000 MHz - 868.600 MHz / 869.700 MHz - 870.000 MHz Alleen voor artikelnummers: SI-S3.*M.WO*, SI-S3.*LN*	<25 mW ERP
2402 MHz - 2480 MHz Alleen voor artikelnummers: SV-S3.*AM.G2*, SV-S3.*A.G2*, SI-S3.*M.WO*, SI-S3.*LN*	2,5 mW

10. Verklaring van overeenstemming

Het bedrijf SimonsVoss Technologies GmbH verklaart dat de artikelen (SI-S3.*M.VCN*, SV-S3.*M.G2*, SV-S3.*AM.G2*, SV-S3.*A.G2*, SI-S3.*M.WO*, SI-S3.*LN*) voldoen aan de volgende richtlijnen:

- 2014/53/EU -RED-
of voor de UK: UK wettelijk 2017 Nr. 1206 -Radioapparatuur-
- 2011/65/EU -RoHS-
of voor de UK: UK wettelijk 2012 Nr. 3032 -RoHS-



De volledige tekst van de EU-conformiteitsverklaring is beschikbaar op het volgende internetadres: www.simons-voss.com/nl/certificaten.html.
De volledige tekst van de UK-conformiteitsverklaring is beschikbaar op het volgende internetadres: www.simons-voss.com/nl/certificaten.html.

11. Hulp en verdere informatie

Informatiemateriaal/documenten

<https://www.simons-voss.com/nl/documenten.html>
<https://www.smartintego.com/int/home/infocenter/documentation>

Conformiteitsverklaringen

<https://www.simons-voss.com/nl/certificaten.html>

Informatie over verwijdering

- Voer het apparaat (SI-S3.*M.VCN*, SV-S3.*M.G2*, SV-S3.*AM.G2*, SV-S3.*A.G2*, SI-S3.*M.WO*, SI-S3.*LN*) niet af als huishoudelijk afval, maar overeenkomstig de Europese Richtlijn 2012/19/EU bij een gemeentelijke inzamelpunt voor speciaal elektrotechnisch afval.
- Zorg voor recycling van defecte of gebruikte batterijen volgens de Europese Richtlijn 2006/66/EG.
- Neem de plaatselijke bepalingen in acht voor de gescheiden afvoer van batterijen.
- Voer de verpakking af naar een instantie voor milieuvriendelijke recycling.



Technische Support

+49 (0) 89 / 99 228 333

E-mail

support-simonsvoss@allegion.com
si-support-simonsvoss@allegion.com

FAQ

<https://faq.simons-voss.com/otrs/public.pl>
SimonsVoss Technologies GmbH, Feringastr. 4, 85774 Unterföhring, Duitsland

Sommar

1.	Avvisi di sicurezza generali	54
2.	Avvertenze di sicurezza specifiche del prodotto	55
3.	Oggetto di fornitura	55
4.	Struttura	55
5.	Preparazione della porta (maschera di foratura)	55
6.	Montaggio della maniglia	55
7.	Smontaggio della maniglia (maniglia di protezione)	57
8.	Sostituzione delle batterie.....	57
9.	Dati tecnici	57
10.	Dichiarazione di conformità	58
11.	Supporto e ulteriori informazioni.....	58

1. Avvisi di sicurezza generali

Parola segnale: Possibili effetti immediati di non conformità

AVVERTENZA: Morte o lesioni gravi (possibili, ma improbabili), **ATTENZIONE:** Lesione minori, **AVVISO:** Danni materiali o malfunzionamento, **NOTA:** Basso o no



AVVERTENZA

Accesso bloccato

Con componenti montati e/o programmati in modo difettoso, l'accesso attraverso una porta può restare bloccato. La SimonsVoss Technologies GmbH non risponde delle conseguenze di un accesso bloccato, per esempio nel caso si debba accedere a persone ferite o in pericolo, di danni a cose o altri danni!

Accesso bloccato tramite manipolazione del prodotto

Se si modifica il prodotto da solo, possono verificarsi malfunzionamenti e l'accesso attraverso una porta può essere bloccato.

- Modificare il prodotto solo quando necessario e solo nel modo descritto nella documentazione.

Non ingerire la batteria. Pericolo di ustioni dovute a sostanze pericolose

Questo prodotto contiene batterie a bottone al litio. Se la batteria a bottone viene inghiottita, possono verificarsi gravi ustioni interne nel giro di sole due ore che possono causare la morte.

1. Conservare le batterie nuove e usate lontano dalla portata dei bambini.
2. Se il vano batteria non si chiude in modo sicuro, interrompere l'uso del prodotto e tenerlo lontano dalla portata dei bambini.
3. Se pensate che le batterie siano state inghiottite o si trovino in una qualsiasi parte del vostro corpo, rivolgetevi immediatamente a un medico.

Pericolo di esplosione a causa di un tipo di batteria non corretto

L'inserimento del tipo di batteria sbagliato può causare un'esplosione.

- Utilizzare solo le batterie specificate nei dati tecnici.



ATTENZIONE

Pericolo di incendio dovuto alle batterie

Le batterie utilizzate possono costituire un pericolo di incendio o combustione in caso di utilizzo scorretto.

1. Non tentare di caricare, aprire, riscaldare o bruciare le batterie.
2. Non cortocircuitare le batterie.

AVVISO

Danni dovuti a scariche elettrostatiche (ESD) quando l'alloggiamento è aperto

Il presente prodotto contiene componenti elettronici che potrebbero subire danni in conseguenza di scariche elettrostatiche.

1. Utilizzare materiali di lavori conformi ai requisiti ESD (ad es. fascetta antistatica al polso).
2. Effettuare la messa a terra dell'operatore prima di eseguire lavori in cui è possibile entrare in contatto con parti elettroniche. A tale scopo, toccare una superficie metallica opportunamente messa a terra (ad es. telaio porta, tubi dell'acqua o valvole di riscaldamento).

Danni dovuti a fluidi

Il presente prodotto contiene componenti elettronici e/o meccanici che potrebbero subire danni dovuti a liquidi di qualunque tipo.

- Tenere i componenti elettronici lontani da liquidi.

Danni dovuti a detergenti aggressivi

La superficie di questo prodotto può essere danneggiata da detergenti non idonei.

- Utilizzare esclusivamente detergenti adatti a superfici in plastica o metallo.

Danni dovuti a effetti meccanici

Il presente prodotto contiene componenti elettronici che potrebbero subire danni dovuti a effetti meccanici di qualunque tipo.

1. Evitare di toccare le parti elettroniche.
2. Evitare ulteriori effetti meccanici sulle parti elettroniche.

Danni dovuti all'inversione di polarità

Questo prodotto contiene componenti elettronici che possono essere danneggiati dall'inversione di polarità della sorgente di tensione.

- Non invertire la polarità della sorgente di tensione (batterie o alimentatori).

Funzionamento disturbato a causa di interferenze radioelettriche

Questo prodotto potrebbe essere influenzato da disturbi elettromagnetici o magnetici.

- Non montare o posizionare il prodotto direttamente accanto a dispositivi che possono causare interferenze elettromagnetiche o magnetiche (alimentatori switching!).

Interferenze nella comunicazione dovute a superfici metalliche

Questo prodotto comunica in modalità wireless. Le superfici metalliche possono ridurre significativamente la portata del prodotto.

- Non montare o posizionare il prodotto sopra o vicino a superfici metalliche.



NOTA

Uso conforme

I prodotti SimonsVoss sono concepiti esclusivamente per l'apertura e la chiusura di porte e oggetti simili.

- Non utilizzare i prodotti SimonsVoss per altri scopi.

Malfunzionamenti dovuti a contatto insufficiente o a scarichi diversi

Superfici di contatto troppo piccole/contaminate o diverse batterie scariche possono portare a malfunzionamenti.

1. Utilizzare esclusivamente batterie autorizzate da SimonsVoss.
2. Non toccare con le mani i contatti delle nuove batterie.
3. Utilizzare guanti puliti e privi di grasso.
4. Sostituire sempre tutte le batterie contemporaneamente.

Tempi diversi per chiusure G2

L'unità temporale interna delle chiusure G2 è tecnicamente vincolata a una tolleranza fino a ± 15 minuti all'anno.

Qualifiche richieste

L'installazione e la messa in servizio richiedono conoscenze specialistiche.

- Solo personale qualificato può installare e mettere in servizio il prodotto.

Non si escludono modifiche o perfezionamenti tecnici, anche senza preavviso.

La versione in lingua tedesca è il manuale di istruzioni originale. Altre lingue (redazione nella lingua del contratto) sono traduzioni delle istruzioni originali.

Leggere e seguire tutte le istruzioni di installazione, installazione e messa in servizio. Passare queste istruzioni e tutte le istruzioni di manutenzione all'utente.

2. Avvertenze di sicurezza specifiche del prodotto

AVVISO

Montaggio difficoltoso a causa di manicotti filettati spinti fuori.

I manicotti filettati sono montati a pressione nella maniglia. La pressione eccessiva durante l'avvitatura a stringere della maniglia sulla piastra di fissaggio può provocare la fuoriuscita dei manicotti filettati dalla maniglia.

1. Non esercitare pressione sulle viti durante l'avvitamento del supporto del modulo.
2. Tenere un dito alle estremità dei manicotti filettati, in modo da opporre resistenza durante l'avvitamento.

3. Oggetto di fornitura

- SmartHandle AX Advanced Maniglia di protezione
- Attrezzo speciale
- Libretto di istruzioni

A seconda della variante:

- Set di adattatori quadro maniglia di 7 mm
- Manicotto adattatore quadro maniglia di 8,5 mm
- Manicotto adattatore quadro maniglia di 10 mm

4. Struttura



5. Preparazione della porta (maschera di foratura)

- ✓ Perno o punta per tracciare a disposizione.
- ✓ Trapano a disposizione.
- ✓ Punta adatta a disposizione (Ø 13 mm).
- ✓ Cacciavite PH2 a disposizione.

1. Inserire il quadro maniglia nella serratura a incasso.
 2
2. Applicare la maschera di foratura sul quadro maniglia.
 3
3. Allineare la maschera di foratura in verticale con l'ausilio della scala graduata.
4. Contrassegnare i fori con la marcatura 1.
 4
5. Rimuovere la maschera di foratura e ruotarla di 180 gradi.
 5
6. Applicare la maschera di foratura sul quadro maniglia.
 6
7. Allineare la maschera di foratura in verticale con l'ausilio della scala graduata.
 7
8. Contrassegnare i fori con la marcatura 2.
 8
9. Rimuovere la maschera di foratura e il quadro maniglia.
 9
10. Rimuovere la serratura a incasso.
 10
11. Praticare i fori necessari.
 11
12.
 12

12. Rimontare la serratura a incasso.



6. Montaggio della maniglia

- ✓ Porta già forata.
- ✓ Cacciavite PH2 a disposizione.
- ✓ Cacciavite TX15 a disposizione.
- ✓ Cacciavite esagonale SW6 a disposizione.
- ✓ Cacciavite esagonale SW5 a disposizione.
- ✓ Calibro a corsoio a disposizione.

1. Inserire il tubo protettivo per quadro maniglia e i dadi a manicotto nella piastra di fissaggio (dado a manicotto corto al centro)



2. Per il quadro maniglia di 7 mm: posizionare la staffetta di adattamento nell'alloggiamento del quadro maniglia del supporto del modulo



3. Inserire il supporto del modulo nella piastra di fissaggio.



AVVISO

Danneggiamento dei dadi a manicotto causato da un inserimento inesatto

Quando le sporgenze dei dadi a manicotto non poggiano negli incavi, possono essere danneggiate durante l'ulteriore montaggio. In questo caso il dado a manicotto può essere trascinato nella rotazione, rendendo difficoltoso il montaggio/lo smontaggio.

- Prestare attenzione al fatto che le sporgenze dei dadi a manicotto poggino negli incavi.



4. Spingere il supporto del modulo verso l'alto.



↳ Il supporto del modulo è innestato.

5. Avvitare il supporto del modulo sulla piastra di fissaggio con le viti da 16 mm (PH2).



6. Misurare lo spessore della porta.



Area	Spessore porta (mm)	Viti (M8)	Vite (M6)
S	39 - <45	25	50
S	45 - <47,5	25	55
S	47,5 - <50	35	55
S	50 - <55	35	60
M	54 - <60	40	65
M	60 - <65	40	70
M	65 - <70	50	75
M	70 - <75	50	80
L	74 - <80	60	85
L	80 - <85	60	90
L	85 - <90	70	95
L	90 - <95	70	100

7. Determinare le viti necessarie con lo spessore porta misurato.





23



24



25



26



27



28



29



30



31



32



33



34



35



36



37



38

8. Inserire il supporto del modulo con la piastra di fissaggio nel lato esterno della porta.



39

AVVISO**Danneggiamento dei dadi a manicotto causato da un inserimento inesatto**

Quando le sporgenze dei dadi a manicotto non poggiano negli incavi, possono essere danneggiate durante l'ulteriore montaggio. In questo caso il dado a manicotto può essere trascinato nella rotazione, rendendo difficoltoso il montaggio/lo smontaggio.

- ▣ Prestare attenzione al fatto che le sporgenze dei dadi a manicotto poggino negli incavi.



17

9. Avvitare saldamente le rondelle e la piastra interna sul supporto del modulo (viti corte SW6, vite lunga al centro SW5).



41

10. Per il quadro maniglia di 8,5 mm e di 10 mm: spingere il manicotto adattatore al centro del quadro maniglia. Con un martello e un punzone realizzare un incavo nel manicotto adattatore per impedire che si muova.



42



43

11. Misurare la lunghezza complessiva del quadro maniglia.



44

12. Rilevare il lato interno del quadro maniglia (dall'estremità del quadro maniglia al centro della prima scanalatura = 26 mm).

13. Determinare la posizione dell'O-ring con la tabella.



45

Area	Spessore porta (mm)	Lunghezza quadro maniglia (mm)	Posizione anello
S	39 - <43	104	2
S	39 - <43	114	4
S	43 - <48	104	1
S	43 - <48	114	3
S	48 - <53	114	2
S	53 - 55	114	1
M	54 - <58	124	3
M	54 - <58	134	5
M	58 - <63	124	2
M	58 - <63	134	4
M	63 - <68	124	1
M	63 - <68	134	3
M	66 - <73	134	2
M	73 - 75	134	1
L	74 - <78	144	3
L	74 - <78	154	5
L	78 - <83	144	2
L	78 - <83	154	4
L	83 - <88	144	1
L	83 - <88	154	3
L	88 - <93	154	2
L	93 - 95	154	1

14. Far scorrere l'O-ring sulla scanalatura calcolata.



46

15. Inserire il lato senza l'anello del quadro maniglia nella porta finché non si arresta.



47

16. Applicare il profilo di riempimento sulla piastra di fissaggio lato interno.



48

17. Per il quadro maniglia di 7 mm: posizionare il manicotto adattatore nella maniglia interna in modo tale che sia visibile l'incavo per la vite senza testa.



49

18. Stabilire il senso di rotazione desiderato della maniglia interna.

19. Inserire l'elemento a molla correttamente.



50



51

20. Posizionare l'unità della maniglia interna sul quadro maniglia.



52

21. Avvitare l'unità della maniglia interna alla piastra di fissaggio con le viti da 12 mm (PH2).



53



54

22. Posizionare la cover in alto sulla piastra di fissaggio.



55

23. Chiudere la cover in basso.







56

24. Spingere la cover verso l'alto.



57

25. Premere saldamente l'inserito.
 58
26. Applicare la maniglia esterna.
 59
27. Avvitare saldamente la maniglia esterna con la vite senza testa (TX15).
 60
28. Avvitare saldamente la maniglia interna con la vite senza testa (TX15).
 61
29. Montare la cover del lato interno seguendo la stessa procedura.
 62
30. Inserire un cilindro di chiusura.

**NOTA****Condizioni per l'omologazione della maniglia di protezione**

L'omologazione di SmartHandle AX Advanced prevede le seguenti condizioni:

1. prestare attenzione alla classe di protezione del cilindro di chiusura.
2. L'alloggiamento del cilindro di chiusura può superare il profilo di protezione del cilindro per 3 mm al massimo.



63



64

31. Fissare il cilindro di chiusura con una vite di ritenuta (PH2).



65

↳ La SmartHandle AX Advanced è completamente montata.

7. Smontaggio della maniglia (maniglia di protezione)

✓ Chiave esagonale da 1,5 mm disponibile.

1. Smontare la maniglia procedendo nella sequenza opposta rispetto al montaggio.
2. Allentare la cover flettendo verso l'esterno l'inserito con l'attrezzo speciale.
3. Inserire una chiave esagonale da 1,5 mm nel foro dell'alloggiamento del quadro maniglia nel supporto del modulo.



66

4. Girare la chiave esagonale dal lato sul quale si trova il foro e contemporaneamente tirare la maniglia esterna.



67

↳ La SmartHandle AX Advanced è smontata.

8. Sostituzione delle batterie

**NOTA****Malfunzionamenti dovuti a contatto insufficiente o a scarichi diversi**

Superfici di contatto troppo piccole/contaminate o diverse batterie scariche possono portare a malfunzionamenti.

1. Utilizzare esclusivamente batterie autorizzate da SimonsVoss.
2. Non toccare con le mani i contatti delle nuove batterie.
3. Utilizzare guanti puliti e privi di grasso.
4. Sostituire sempre tutte le batterie contemporaneamente.

















✓ Attrezzo speciale a disposizione.

✓ Guanti a disposizione.



1. Inserire l'attrezzo speciale nell'inserito della cover della parte elettronica.



68

2. Con l'attrezzo speciale, flettere l'inserito della cover con cautela.
 69
 3. Spingere la cover verso il basso.
 70
↳ La cover si sblocca.
 4. Rimuovere la cover.
 71
 5. Con l'attrezzo speciale, sganciare la clip del modulo delle batterie.
 72
 6. Rimuovere il modulo delle batterie.
 73
 7. Con l'attrezzo speciale, sganciare la clip delle batterie.
 74
 8. Rimuovere le batterie superiori.
 75
 9. Sollevare la linguetta intermedia verso il bordo con cautela.
 10. Rimuovere le batterie inferiori.
 76
 11. Inserire due batterie nuove in modo tale che i poli positivi si tocchino (CR2450).
 77
↳ Linguetta intermedia visibile sulle batterie inferiori.
 12. Inserire due batterie nuove in modo tale che i poli positivi si tocchino (CR2450).
 78
 13. Agganciare nuovamente la clip delle batterie.
 79
 14. Reinscrivere il modulo delle batterie nel supporto del modulo.
 80
 15. Con l'attrezzo speciale, riagganciare la clip del modulo delle batterie.
 81
↳ La SmartHandle AX Advanced emette tre segnali acustici.
 16. Posizionare la cover in alto sulla piastra di fissaggio.
 82
 17. Chiudere la cover in basso.
 83
 18. Premere contemporaneamente la cover contro la porta e verso l'alto.
 84
↳ La cover si innesta.
 19. Premere saldamente l'inserito.
 85
- ↳ Le batterie sono sostituite.

9. Dati tecnici

Range di temperature (esercizio)	da -25 °C a +60 °C
Tipo di batteria	4 × CR2450 3V al litio
Marca delle batterie	 Murata  Panasonic  Varta
Grado di protezione	Fino a IP66 (variante WP)

Emissioni radio

15,24 kHz - 72,03 kHz Solo per i codici articolo: SV-S3.*AM.G2*, SV-S3.*A.G2*, SI-S3.*LN*	10 dBμA/m (3 m distanza)
--	--------------------------

13,560006 MHz - 13,560780 MHz Solo per i codici articolo: SV-S3.*AM.G2*, SV-S3.*A.G2*, SI-S3.*M.WO*, SI-S3.*LN*	1,04 dBµA/m (3 m distanza)
868,000 MHz - 868,600 MHz / 869,700 MHz - 870,000 MHz Solo per i codici articolo: SI-S3.*M.WO*, SI-S3.*LN*	<25 mW ERP
2402 MHz - 2480 MHz Solo per i codici articolo: SV-S3.*AM.G2*, SV-S3.*A.G2*, SI-S3.*M.WO*, SI-S3.*LN*	2,5 mW

10. Dichiarazione di conformità

Het bedrijf SimonsVoss Technologies GmbH verklaart hierbij dat de artikelen (SI-S3.*M.VCN*, SV-S3.*M.G2*, SV-S3.*AM.G2*, SV-S3.*A.G2*, SI-S3.*M.WO*, SI-S3.*LN*) voldoet aan de volgende richtlijnen:

- 2014/53/UE -RED-
o per il Regno Unito: Normativa del Regno Unito 2017 n. 1206
-Apparecchiature radio-
- 2011/65/UE -RoHS-
o per il Regno Unito: Normativa del Regno Unito 2012 n. 3032 -RoHS-



Il testo integrale della dichiarazione di conformità UE è disponibile al seguente indirizzo Internet: www.simons-voss.com/it/certificati.html.

Il testo integrale della dichiarazione di conformità UK è disponibile al seguente indirizzo Internet: www.simons-voss.com/it/certificati.html.

11. Supporto e ulteriori informazioni

Materiale informativo/Documenti

<https://www.simons-voss.com/it/documenti.html>

<https://www.smartintego.com/int/home/infocenter/documentation>

Dichiarazioni di conformità

<https://www.simons-voss.com/it/certificati.html>

Informazioni sullo smaltimento

- Il dispositivo (SI-S3.*M.VCN*, SV-S3.*M.G2*, SV-S3.*AM.G2*, SV-S3.*A.G2*, SI-S3.*M.WO*, SI-S3.*LN*) non va smaltito fra i rifiuti domestici, ma conferito presso un centro di raccolta comunale per rifiuti elettronici speciali in conformità con la Direttiva Europea 2012/19/UE.
- Riciclare le batterie guaste o esauste ai sensi della Direttiva Europea 2006/66/CE.
- Osservare le disposizioni locali in materia di smaltimento speciale delle batterie.
- Conferire l'imballaggio presso un punto di raccolta ai fini del riciclaggio ecologico.



86

Supporto tecnico

+49 (0) 89 / 99 228 333

E-mail

support-simonsvoss@allegion.com

si-support-simonsvoss@allegion.com

FAQ

<https://faq.simons-voss.com/otrs/public.pl>

SimonsVoss Technologies GmbH, Feringastr. 4, D-85774 Unterfoehring, Germania

Indholdsfortegnelse

1.	Generelle sikkerhedshenvisninger.....	60
2.	Produktspecifikke sikkerhedsanvisninger	60
3.	Leveringsomfang	60
4.	Montering	61
5.	Forbered døren (boreskabelon)	61
6.	Monter beslaget	61
7.	Afmontering af beslag (sikkerhedsbeslag)	62
8.	Udskiftning af batterier.....	63
9.	Tekniske data.....	63
10.	Overensstemmelseserklæring	63
11.	Hjælp og flere oplysninger	63

1. Generelle sikkerhedshenvisninger

Signalord: Mulige direkte virkninger i tilfælde af manglende overholdelse
ADVARSEL: Død eller alvorlig personskade (muligt, men usandsynligt), **FOR-**
SIGTIG: Mindre skade, **OPMÆRKSOMHED:** Materiel skade eller fejlfunktion,
BEMÆRK: Lidt eller ingen



ADVARSEL

Spærret adgang

Hvis komponenter er fejlagtigt monteret og/eller programmeret, kan adgang til en dør forblive spærret. For følgeskader, der skyldes spærret adgang, fx til personer, der er sårede eller i fare, tingsskader eller andre skader, hæfter SimonsVoss Technologies GmbH ikke!

Blokeret adgang gennem manipulation af produktet

Hvis du selv ændrer produktet, kan der opstå funktionsfejl, og adgang via en dør kan blokeres.

- Modificer kun produktet, når det er nødvendigt, og kun på den måde, der er beskrevet i dokumentationen.

Batteri må ikke indtages. Forbrændingsfare på grund af farlige stoffer

Dette produkt indeholder litium-knappceller. Hvis knapcellen sluges, kan det medføre alvorlige indre forbrændinger inden for to timer og dødsfald.

1. Opbevar nye og brugte batterier uden for børns rækkevidde.
2. Hvis batterirummet ikke kan lukkes ordentligt, må produktet ikke længere benyttes, og det opbevares uden for børns rækkevidde.
3. Hvis du tror, at batterier er blevet slugt eller befinder sig i en legemsdel, skal du straks søge lægehjælp.

Eksplodingsfare på grund af forkert batteritype

Isætning af den forkerte batteritype kan resultere i en eksplosion.

- Brug kun de batterier, der er specificeret i de tekniske data.



FORSIGTIG

Brandfare ved batterier

Batterierne kan udgøre en brand- eller forbrændingsfare ved forkert behandling.

1. Forsøg ikke at oplade, åbne, opvarme eller brænde batterierne.
2. Kortslut ikke batterierne.

OPMÆRKSOMHED

Beskadigelse på grund af elektrostatisk afladning (ESD) med huset åbent

Dette produkt indeholder elektroniske komponenter, som kan blive beskadiget på grund af elektrostatisk afladning.

1. Brug ESD-beskyttede arbejdsmaterialer (f.eks. jordforbindelsesbånd).
2. Opret jordforbindelse før arbejde, hvor du kan komme i kontakt med elektronikken. Indfat i denne forbindelse jordforbundne metaloverflader (f.eks. dørkarme, vandør eller varmeventiler).

Beskadigelse på grund af væske

Dette produkt indeholder elektroniske og/eller mekaniske komponenter, som kan blive beskadiget på grund af alle typer væsker.

- Hold væsker væk fra elektronikken.

Beskadigelse på grund af aggressive rengøringsmidler

Produktets overflade kan blive beskadiget på grund af uegnede rengøringsmidler.

- Brug kun rengøringsmidler, der er velegnede til kunststof- og metaloverflader.

Beskadigelse på grund af mekanisk påvirkning

Dette produkt indeholder elektroniske komponenter, som kan blive beskadiget på grund af alle typer mekanisk påvirkning.

1. Undgå at berøre elektronikken.
2. Undgå at udsætte elektronikken for andre mekaniske påvirkninger.

Beskadigelse på grund af fejltlslutning

Dette produkt indeholder elektroniske komponenter, som kan blive beskadiget på grund af fejltlslutning af spændingskilden.

- Sørg for ikke at fejltlslutte spændingskilden (batterier eller netdele).

Driftsforstyrrelse på grund af radiostøj

Dette produkt kan under visse omstændigheder påvirkes af elektromagnetiske eller magnetiske forstyrrelser.

- Montér eller anbring ikke produktet umiddelbart i nærheden af enheder, som kan medføre elektromagnetiske eller magnetiske forstyrrelser (strømforsyninger!).

Kommunikationsfejl på grund af metaloverflader

Dette produkt kommunikerer trådløst. Metaloverflader kan reducere produktets rækkevidde væsentligt.

- Montér eller anbring ikke produktet på eller i nærheden af metaloverflader.



BEMÆRK

Korrekt anvendelse

SimonsVoss-produkter er kun beregnet til åbning og lukning af døre og sammenlignelige genstande.

- Anvend ikke SimonsVoss-produkter til andre formål.

Funktionsfejl på grund af dårlig kontakt eller anden afladning

For små / forurenede kontaktområder eller forskellige afladede batterier kan føre til funktionsfejl.

1. Anvend kun batterier, som er frigivet af SimonsVoss.
2. Berør ikke de nye batteriers kontakter med hænderne.
3. Anvend rene og fedtfrie handsker.
4. Skift derfor altid alle batterier samtidigt.

Afvigende tidspunkter ved G2-lukninger

Den interne tidsenhed ved G2-lukninger har en teknisk betinget tolerance på op til ± 15 minutter om året.

Krævede kvalifikationer

Installation og idriftsættelse kræver specialiseret viden.

- Kun uddannet personale må installere og idriftsætte produktet.

Ændringer eller tekniske videreudviklinger kan ikke udelukkes og kan foretages uden forudgående varsel.

Den tyske sprogversion er den originale brugsanvisning. Andre sprog (udkast på kontraktspøget) er oversættelser af de originale instruktioner.

Læs og følg alle installations-, installations- og idriftsættelsesinstruktioner. Overfør disse instruktioner og eventuel vedligeholdelsesinstruktion til brugeren.

2. Produktspecifikke sikkerhedsanvisninger

OPMÆRKSOMHED

Vanskelig samling på grund af gevindbøsninger, der presses ud

Gevindbøsningerne i beslaget er monteret med prespasning Et for stort tryk, når beslaget skrues fast på fastgørelsespladen, kan få gevindbøsningerne til at glide ud af beslaget.

1. Tryk ikke på skruerne, når du skruer modulholderen fast.
2. Brug en finger på enderne af gevindbøsningerne til at holde imod, mens du skruer.

3. Leveringsomfang













- SmartHandle AX Advanced Sikkerhedsbeslag
 - Specialværktøj
 - Kort vejledning
- Afhængigt af variant:

- Adaptersæt 7 mm firkant
- Adaptertulle 8,5 mm firkant
- Adaptertulle 10 mm firkant



4. Montering



5. Forbered døren (boreskabelon)

- ✓ Blyant eller ridsenål til stede.
 - ✓ Boremaskine til rådighed.
 - ✓ Der er et passende bor (Ø 13 mm) til rådighed.
 - ✓ PH2-skruetrækker til rådighed.
1. Sæt firkanten ind i indstikslåsen.
  2
 2. Sæt boreskabelonen på firkanten.
  3
 3. Juster boreskabelonen lodret ved hjælp af den påtrykte skala.
 4. Marker borehullerne med mærke 1.
  4
 5. Fjern boreskabelonen, og drej den 180 grader.
  5
  6
 6. Sæt boreskabelonen på firkanten.
  7
 7. Juster boreskabelonen lodret ved hjælp af den påtrykte skala.
 8. Markér borehullet med mærke 2.
  8
 9. Fjern boreskabelonen og firkanten.
  9
  10
 10. Fjern indstikslåsen.
  11
 11. Bor de nødvendige huller.
  12
 12. Monter indstikslåsen.
  13

6. Monter beslaget

- ✓ Døren er forboret.
 - ✓ PH2-skruetrækker til rådighed.
 - ✓ TX15-skruetrækker til rådighed.
 - ✓ SW6 sekskantskruetrækker til rådighed.
 - ✓ SW5 sekskantskruetrækker til rådighed.
 - ✓ Måleapparat til kalibre er tilgængeligt.
1. Indsæt firkantens beskyttelsesrør og hylstermøtrikkerne i fastgørelsespladen (den korte hylstermøtrik i midten).
  14
 2. For 7 mm firkant: Placer adapterskoen i modulholderens firkantede hul.
  15
 3. Sæt modulholderen ind i fastgørelsespladen.
  16

OPMÆRKSOMHED

Beskadigelse af hylstermøtrikkerne på grund af forkert isætning

Hvis hylstermøtrikkernes tapper ikke sidder i fordybningerne, kan de blive beskadiget under den videre montering. I dette tilfælde kan hylstermøtrikken også dreje, og montering/afmontering besværliggøres.

- Sørg for, at hylstermøtrikkernes tapper sidder i fordybningerne.



4. Skub modulholderen opad.



- ↳ Modulholderen klikker på plads.

5. Skru modulholderen fast til fastgørelsespladen med 12 mm skrue (PH2).



6. Mål dørens tykkelse.



Område	Dørtykkelse (mm)	Skrue (M8)	Skrue (M6)
S	39 - <45	25	50
S	45 - <47,5	25	55
S	47,5 - <50	35	55
S	50 - <55	35	60
M	54 - <60	40	65
M	60 - <65	40	70
M	65 - <70	50	75
M	70 - <75	50	80
L	74 - <80	60	85
L	80 - <85	60	90
L	85 - <90	70	95
L	90 - <95	70	100

7. Bestem de nødvendige skrue ud fra den målte dørtykkelse.



8. Stik modulholderen med fastgørelsespladen ind i dørens yderside.



39

OPMÆRKSOMHED

Beskadigelse af hylstermøtrikkerne på grund af forkert isætning

Hvis hylstermøtrikkerens tapper ikke sidder i fordybningerne, kan de blive beskadiget under den videre montering. I dette tilfælde kan hylstermøtrikken også dreje, og montering/afmontering besværliggøres.

- ❗ Sørg for, at hylstermøtrikkerens tapper sidder i fordybningerne.



17

9. Skru skiverne og den indvendige plade fast til modulholderen (korte skrue SW6, lang skrue i midten SW5).



41

10. Til 8,5 mm og 10 mm firkant: Skub adaptertyllen ind i midten af firkanten. Lav en fordybning i adaptertyllen med en hammer og en kørner for at forhindre, at den glider.



42



43

11. Mål firkantens samlede længde.



44

12. Bestem firkantens inderside (firkantens ende til midten af den første rille = 26 mm).

13. Bestem O-ringens placering med tabellen.



45

Område	Dørtykkelse (mm)	Firkantens længde (mm)	Ringens position
S	39 - <43	104	2
S	39 - <43	114	4
S	43 - <48	104	1
S	43 - <48	114	3
S	48 - <53	114	2
S	53 - 55	114	1
M	54 - <58	124	3
M	54 - <58	134	5
M	58 - <63	124	2
M	58 - <63	134	4
M	63 - <68	124	1
M	63 - <68	134	3
M	66 - <73	134	2
M	73 - 75	134	1
L	74 - <78	144	3
L	74 - <78	154	5
L	78 - <83	144	2
L	78 - <83	154	4
L	83 - <88	144	1
L	83 - <88	154	3
L	88 - <93	154	2
L	93 - 95	154	1

14. Skub O-ringens ind i den beregnede rille.



46

15. Sæt firkanten med den ringfrie side så langt ind i døren, som den kan komme.



47

16. Sæt udfyldningsprofilen på den indvendige fastgørelsesplade.



48

17. For 7 mm firkant: Placer adaptertyllen i det indvendige håndtag, så udsparingen vender mod skruestiften.



49

18. Bestem den ønskede drejerejning for dit indvendige håndtag.

19. Indsæt fjeder-elementet i overensstemmelse hermed.



50



51

20. Sæt den indvendige håndtagsenhed på firkanten.



52

21. Skru den indvendige håndtagsenhed fast på fastgørelsespladen (PH2) med 12 mm skrue.



53

22. Placer dækslet oven på fastgørelsespladen.



54

23. Klap dækslet ned.



55

24. Skub dækslet opad.



56

25. Tryk indlægget fast.



57

26. Sæt det udvendige håndtag på.



58

27. Brug gevindskruen til at skru det udvendige håndtag (TX15) fast.



59

28. Brug gevindskruen til at skru det indvendige håndtag (TX15) fast.



60

29. Monter dækslet til indersiden på samme måde.



61

30. Indsæt en låsecylinder.



62



BEMÆRK

Betingelser for godkendelse af sikkerhedsbeslag

Godkendelsen af SmartHandle AX Advanced er underlagt visse betingelser:

- Vær opmærksom på låsecylinderens beskyttelsesklasse.
- Låsecylinderens hus må ikke rage mere end 3 mm ud over cylinderens beskyttelsesprofil.



63



64

31. Fastgør låsecylinderen med en frontpladeskrue (PH2).



65

- ← SmartHandle AX Advanced færdigmonteret.

7. Afmontering af beslag (sikkerhedsbeslag)

- ✓ Anvend 1,5 mm unbrakonøgle.

- Afmonter beslaget i omvendt rækkefølge i forhold til monteringen.
- Løsn dækslet ved at bøje indlægget udad med specialværktøjet.
- Sæt en 1,5 mm sekskantnøgle ind i det dertil beregnede hul i firkantholderen i modulholderen.



66

4. Bøj sekskantnøglen til den side, hvor hullet er placeret, og træk samtidig i det udvendige håndtag.



67

- ↳ SmartHandle AX Advanced er afmonteret.

8. Udskiftning af batterier



BEMÆRK

Funktionsfejl på grund af dårlig kontakt eller anden afladning

For små / forurenede kontaktområder eller forskellige afladede batterier kan føre til funktionsfejl.

1. Anvend kun batterier, som er frigivet af SimonsVoss.
2. Berør ikke de nye batteriers kontakter med hænderne.
3. Anvend rene og fedtfrie handsker.
4. Skift derfor altid alle batterier samtidigt.

- ✓ Specialværktøj er tilgængeligt.

- ✓ Handsker er tilgængeligt.

1. Sæt specialværktøjet ind i dækslet på elektroniksidens.



68

2. Brug specialværktøjet til at bøje dækslet forsigtigt op.



69

3. Skub dækslet ned.



70

- ↳ Dækslet er ikke låst op.

4. Fjern dækslet.



71

5. Løsn batterimodules clips med specialværktøjet.



72

6. Fjern batterimodulet.



73

7. Løsn batteriklipsen med specialværktøjet.



74

8. Fjern de øverste batterier.



75

9. Bøj forsigtigt den mellemliggende fjeder til siden.

10. Fjern de nederste batterier.



76

11. Sæt to nye batterier i med de positive poler i berøring (type CR2450).



77

- ↳ Den mellemliggende fjeder er synlig over de nederste batterier.

12. Sæt to nye batterier i med de positive poler i berøring (type CR2450).



78

13. Sæt batteriklipsen på plads igen.



79

14. Sæt batterimodulet tilbage i modulholderen.



80

15. Brug specialværktøjet til at sætte batterimodules clips på plads igen.



81

- ↳ SmartHandle AX Advanced bipper tre gange.

16. Placer dækslet oven på fastgørelsespladen.



82

17. Klap dækslet ned.



83

18. Tryk dækslet mod døren og skub det samtidig opad.



84

- ↳ Dækslet klikkes på plads.

19. Tryk indlægget fast.



85

- ↳ Batterierne er udskiftet.

9. Tekniske data

Temperaturområde (drift)	-25 °C til +60 °C
Batteritype	4 × CR2450 3V lithium
Batteriproducent	<ul style="list-style-type: none"> ■ Murata ■ Panasonic ■ Varta
IP-kapslingsklasse	Op til IP66 (WP-variant)

Radio emissies

15,24 kHz - 72,03 kHz Kun for artikelnumre: SV-S3.*AM.G2*, SV-S3.*A.G2*, SI-S3.*LN*	10 dBµA/m (3 m afstand)
13,560006 MHz - 13,560780 MHz Kun for artikelnumre: SV-S3.*AM.G2*, SV-S3.*A.G2*, SI-S3.*M.WO*, SI-S3.*LN*	1,04 dBµA/m (3 m afstand)
868,000 MHz - 868,600 MHz / 869,700 MHz - 870,000 MHz Kun for artikelnumre: SI-S3.*M.WO*, SI-S3.*LN*	<25 mW ERP
2402 MHz - 2480 MHz Kun for artikelnumre: SV-S3.*AM.G2*, SV-S3.*A.G2*, SI-S3.*M.WO*, SI-S3.*LN*	2,5 mW

10. Overensstemmelseserklæring

Herved erklærer SimonsVoss Technologies GmbH at varen (SI-S3.*M.VCN*, SV-S3.*M.G2*, SV-S3.*AM.G2*, SV-S3.*A.G2*, SI-S3.*M.WO*, SI-S3.*LN*) overholder følgende retningslinjer:

- 2014/53/EU - RED- eller for Storbritannien: UK lovbekendtgørelse 2017 nr. 1206 -Radloudstyr-
- 2011/65/EU -RoHS- eller for Storbritannien: UK lovbekendtgørelse 2012 nr. 3032 -RoHS-



Den fulde ordlyd af EU-overensstemmelseserklæringen er tilgængelig på følgende internetadresse: www.simons-voss.com/dk/certifikater.html.

Den fulde ordlyd af UK-overensstemmelseserklæringen er tilgængelig på følgende internetadresse: www.simons-voss.com/dk/certifikater.html.

11. Hjælp og flere oplysninger

Infomateriale/dokumenter

<https://www.simons-voss.com/dk/dokumenter.html>

<https://www.smartintego.com/int/home/infocenter/documentation>

Overensstemmelseserklæringer

<https://www.simons-voss.com/dk/certifikater.html>

Oplysninger om bortskaffelse

- Enheden (SI-S3.*M.VCN*, SV-S3.*M.G2*, SV-S3.*AM.G2*, SV-S3.*A.G2*, SI-S3.*M.WO*, SI-S3.*LN*) må ikke bortskaffes med husholdningsaffaldet, men skal afleveres på den kommunale affaldsplads, jf. det europæiske direktiv 2012/19/EU.
- Brugte eller defekte batterier skal genanvendes jf. det europæiske direktiv 2006/66/EG.

- Overhold de lokale bestemmelser for separat bortskaffelse af batterier.
- Aflever emballagen til miljørigtig genanvendelse.



Teknisk support

+49 (0) 89 / 99 228 333

e-mail

support-simonsvoss@allegion.com

si-support-simonsvoss@allegion.com

FAQ

<https://faq.simons-voss.com/otrs/public.pl>

SimonsVoss Technologies GmbH, Feringastr. 4, D-85774 Unterföhring,
Tyskland

Innehållsförteckning

1. Allmänna säkerhetsanvisningar	66
2. Produktspecifika säkerhetsanvisningar	66
3. Leveransomfång	66
4. Uppbyggnad	67
5. Förbereda dörr (borschablon)	67
6. Montera handtag	67
7. Demontera handtag (skyddshandtag)	68
8. Byt batterier	69
9. Tekniska data	69
10. Försäkran om överensstämmelse	69
11. Hjälp och ytterligare information	69

1. Allmänna säkerhetsanvisningar

Signalord: Eventuella omedelbara effekter av bristande efterlevnad
VARNING: Död eller allvarlig skada (möjligt, men osannolikt), **OBSERVERA:** Liten skada, OBS: Skador på egendom eller fel, INFO: Låg eller ingen



VARNING

Tillgång spärrad

Felaktigt installerade och/eller programmerade komponenter kan leda till att dörrar spärras, SimonsVoss Technologies GmbH ansvarar inte för konsekvenserna av felaktig installation såsom spärrat tillträde till skadade personer eller personer i risksituationer, materiella skador eller andra typer av skador.

Blockerad åtkomst genom manipulering av produkten

Om du ändrar produkten på egen hand kan fel uppstå och åtkomst via en dörr kan blockeras.

- Ändra endast produkten vid behov och endast på det sätt som beskrivs i dokumentationen.

Svälj inte batterier. Risk för brännskador på grund av farliga ämnen.

Den här produkten innehåller litiumknappcells-batterier. Om man råkar svälja ett knappcells-batteri kan allvarliga inre brännskador uppstå inom bara två timmar vilket i sin tur kan leda till döden.

- Förvara nya och förbrukade batterier utom räckhåll för barn.
- Upphör att använda produkten och förvara den utom räckhåll för barn om batterilocket inte går att stänga ordentligt.
- Uppsök omedelbart läkare om du misstänker att batterier har svalts eller befinner sig i någon kroppsdela.

Explosionsrisk på grund av felaktigt batterityp

Att sätta i fel typ av batteri kan leda till en explosion.

- Använd endast de batterier som anges i de tekniska data.



OBSERVERA

Brandrisk som utgår från batterier

De isatta batterierna kan orsaka brand eller brännskador om de hanteras på ett felaktigt sätt.

- Försök inte att ladda upp, öppna eller värma upp batterierna.
- Kortslut inte batterierna.

OBS

Skador på grund av elektrostatisk urladdning (ESD) när hölet är öppet

Den här produkten innehåller elektroniska komponenter som kan skadas av elektrostatiska urladdningar.

- Använd alltid ESD-anpassat arbetsmaterial (t.ex. jordningsarmband).
- Jorda dig före alla arbeten där du kan komma i kontakt med elektronik. Det gör du genom att fatta tag i en jordad metallta (såsom dörrkarmar, vattenrör eller värmeventiler).

Skada på grund av vätskor

Den här produkten innehåller elektroniska och/eller mekaniska komponenter som kan skadas av alla typer av vätskor.

- Låt inte elektroniken komma i kontakt med vätskor.

Skada på grund av aggressiva rengöringsmedel

Ytan på den här produkten kan skadas om olämpliga rengöringsmedel används.

- Använd endast rengöringsmedel som lämpar sig för plast- och metalltyper.

Skada på grund av mekanisk påverkan

Den här produkten innehåller elektroniska komponenter som kan skadas av alla typer av mekanisk påverkan.

- Undvik att vidröra elektroniken.
- Undvik annan mekanisk påverkan på elektroniken.

Skada på grund av polvändning

Den här produkten innehåller elektroniska komponenter som kan skadas på grund av polvändning i spänningskällan.

- Vänd inte spänningskällans poler (batterier resp. nätdelar).

Driftstörning på grund av radiostörning

Den här produkten kan i vissa fall påverkas av elektromagnetiska eller magnetiska störningar.

- Produkten ska inte monteras eller placeras i omedelbar närhet av utrustning som kan orsaka elektromagnetiska eller magnetiska störningar (switchade nätaggregat!).

Kommunikationsstörning på grund av metalltytor

Den här produkten kommunicerar trådlöst. Metalltytor kan minska produktens räckvidd avsevärt.

- Produkten ska inte monteras eller placeras på eller i närheten av metalltytor.



INFO

Avsedd användning

SimonsVoss-produkter är uteslutande avsedda för öppning och stängning av dörrar och liknande.

- Använd inte SimonsVoss-produkter för andra syften.

Funktionsstörningar på grund av dålig dålig kontakt eller annan urladdning

För små / kontaminerade kontaktytor eller olika urladdade batterier kan leda till funktionsstörningar.

- Används endast batterier som är godkända av SimonsVoss.
- Vidrör inte de nya batteriernas kontakter med händerna.
- Använd rena och fettfria handskar.
- Byt alltid alla batterier samtidigt.

Avvikande tider vid G2-lås

G2-låsens interna tidsenhet har en tekniskt betingad tolerans på upp till ± 15 minuter per år.

Kvalifikationer krävs

Installation och idrifttagning kräver specialiserad kunskap.

- Endast utbildad personal får installera och driftsätta produkten.

Ändringar eller teknisk vidareutveckling kan inte uteslutas och kan komma att genomföras utan föregående meddelande om detta.

Den tyska språkversionen är den ursprungliga bruksanvisningen. Andra språk (utarbetade på kontraktsspråket) är översättningar av originalinstruktionerna.

Läs och följ alla installations-, installations- och driftsinstruktioner. Skicka dessa instruktioner och alla underhållsinstruktioner till användaren.

2. Produktspecifika säkerhetsanvisningar

OBS

Försvårad montering på grund av att gänghylsor har tryckts ut

Gänghylsorna i handtaget är monterade med en presspassning. Om man trycker för hårt när handtaget skruvas fast på fixeringsplattan kan leda till att gänghylsorna glider på handtaget.

- Tryck inte på skruvarna när modulhållaren skruvas fast.
- Håll emot med ett finger på gänghylsornas ändrar vid fastskruvning.

3. Leveransomgång

- SmartHandle AX Advanced Skyddshandtag

- Specialverktyg

- Snabbguide

Beroende på variant:











- Adaptersats 7 mm-fyrkant

- Adapterhylsa 8,5 mm-fyrkant
- Adapterhylsa 10 mm-fyrkant



4. Uppbyggnad



5. Förbereda dörr (borrschablon)

- ✓ Stift eller ritsnål finns.
 - ✓ Borrmaskin finns.
 - ✓ Lämpligt borrstål (Ø 13 mm).
 - ✓ PH2-skruvmejsel finns.
1. Stick in fyrkanten i instickslåset.
  2
 2. Sätt på borrschablonen på fyrkanten.
  3
 3. Rikta in borrschablonen lodrätt med hjälp av den påtryckta skalans.
 4. Markera borrhålen med markering 1.
  4
 5. Avlägsna borrschablonen och vrid den 180 grader.
  5
 6. Sätt på borrschablonen på fyrkanten.
  6
 7. Rikta in borrschablonen lodrätt med hjälp av den påtryckta skalans.
 8. Markera borrhålet med markering 2.
  8
 9. Ta bort borrschablonen och fyrkanten.
  9
 10. Demontera instickslåset.
  10
 11. Borra de hål som behövs.
  11
 12. Montera instickslåset.
  12
 13.
  13

6. Montera handtag

- ✓ Dörr förborrad.
 - ✓ PH2-skruvmejsel finns.
 - ✓ TX15-skruvmejsel finns.
 - ✓ SW6-insexnyckel finns.
 - ✓ SW5-insexnyckel finns.
 - ✓ Mätare för kalibreringsmått finns.
1. Sätt in fyrkantsskyddsroret och hylsmuttrarna i fixeringsplattan (den korta hylsmuttern i mitten).
  14
 2. För 7 mm-fyrkant: Sätt i adapterskon i modulhållarens fyrkantsfäste.
  15
 3. Sätt in modulhållaren i fixeringsplattan.
  16

OBS

Skada på hylsmuttrarna på grund av felaktig montering

Om stiften på hylsmuttrarna inte sitter korrekt i ursparringarna kan de skadas under den fortsatta monteringen. I detta fall kan hylsmuttrarna vridas med vilket försvårar montering/demontering.

- Kontrollera att hylsmuttrarnas stift sitter korrekt i ursparringarna.



4. Skjut modulhållaren uppåt.



4. Modulhållaren hakar i.

5. Skruva fast modulhållaren på fixeringsplattan med 16 mm-skruvorna (PH2).



6. Mät dörrtjockleken.



Område	Dörrtjocklek (mm)	Skruv (M8)	Skruv (M6)
S	39-< 45	25	50
S	45-< 47,5	25	55
S	47,5-< 50	35	55
S	50-< 55	35	60
M	54-< 60	40	65
M	60-< 65	40	70
M	65-< 70	50	75
M	70-< 75	50	80
L	74-< 80	60	85
L	80-< 85	60	90
L	85-< 90	70	95
L	90-< 95	70	100

7. Bestäm vilka skruvar som behövs utifrån den uppmätta dörrtjockleken.



8. Sätt i modulhållaren med fixeringsplattan på dörrens ytersida.



39

OBS**Skada på hylsmuttrarna på grund av felaktig montering**

Om stiften på hylsmuttrarna inte sitter korrekt i ursparningarna kan de skadas under den fortsatta monteringen. I detta fall kan hylsmuttrarna vridas med vilket försvårar montering/demontering.

- Kontrollera att hylsmuttrarnas stift sitter korrekt i ursparningarna.



17

9. Skruv fast brickan och innerplattan på modulhållaren (korta skruvar SW6, lång skruv i mitten SW5).



41

10. För 8,5 mm- och 10 mm-fyrkant: Skjut in adapterhylsan i mitten av fyrkanten. Gör en fördjupning i adapterhylsan med en kornare och hammare för att förhindra att den glider.



42



43

11. Mät fyrkantens totallängd.



44

12. Fastställ fyrkantens insida (fyrkantsände till mitten av första spår = 26 mm).

13. Bestäm O-ringens position med tabellen.



45

Område	Dörrtjocklek (mm)	Fyrkantenslängd (mm)	Ringposition
S	39 - <43	104	2
S	39 - <43	114	4
S	43 - <48	104	1
S	43 - <48	114	3
S	48 - <53	114	2
S	53 - 55	114	1
M	54 - <58	124	3
M	54 - <58	134	5
M	58 - <63	124	2
M	58 - <63	134	4
M	63 - <68	124	1
M	63 - <68	134	3
M	66 - <73	134	2
M	73 - 75	134	1
L	74 - <78	144	3
L	74 - <78	154	5
L	78 - <83	144	2
L	78 - <83	154	4
L	83 - <88	144	1
L	83 - <88	154	3
L	88 - <93	154	2
L	93 - 95	154	1

14. Skjut på O-ringen på det beräknade spåret.



46

15. Skjut in fyrkanten med den ringfria sidan till anslag i dörren.



47

16. Sätt på utfyllnadsprofilen på den invändiga fixeringsplattan.



48

17. För 7 mm-fyrkant: Sätt i adapterhylsan i innerhandtaget så att ursparningen är vänd mot stoppskruven.



49

18. Fastställ önskad vridriktning för innerhandtaget.

19. Sätt i fjäderelementet enligt motsvarande.



50



51

20. Skjut på innerhandtagsenheten på fyrkanten.



52

21. Skruva fast innerhandtagsenheten på fixeringsplattan med 12 mm-skruvarna (PH2).



53



54

22. Sätt på kåpan upp till på fixeringsplattan.



55

23. Fäll kåpan nedåt.



56

24. Skjut kåpan uppåt.



57

25. Tryck fast inlägget.



58

26. Sätt fast ytterhandtaget.



59

27. Skruva fast ytterhandtaget med stoppskruven (TX15).



60

28. Skruva fast innerhandtaget med stoppskruven (TX15).



61

29. Montera även kåpan för insidan.



62

30. Sätt i en låscylinde.

**INFO****Villkor för godkännande av skyddshandtag**

Godkännandet av SmartHandle AX Advanced styrs av villkor:

- Kontrollera låscylinterns skyddsklass.
- Låscylinterns hus får sticka ut maximalt 3 mm från cylinderskyddsprofilen.



63



64

31. Sätt fast låscylinde med en cylinderskruv (PH2).



65

- ← SmartHandle AX Advanced är färdigmonterat.

7. Demontera handtag (skyddshandtag)

- ✓ 1,5 mm sexkantnyckel finns.

- Demontera handtaget i omvänd ordningsföljd jämfört med montering.
- Lossa kåpan genom att böja inlägget utåt med hjälp av specialverktyget.

3. Sätt i en 1,5 mm-insexnyckel i hålet på fyrkantfästet i modulhållaren.



66

4. Böj insexnyckeln åt den sida där hålet sitter och dra samtidigt i ytterhandtaget.



- ↳ SmartHandle AX Advanced har demonterats.

8. Byt batterier.



INFO

Funktionsstörningar på grund av dålig dålig kontakt eller annan urladdning

För små / kontaminerade kontaktytor eller olika urladdade batterier kan leda till funktionsstörningar.

1. Används endast batterier som är godkända av SimonsVoss.
2. Vidrör inte de nya batteriernas kontakter med händerna.
3. Använd rena och fettfria handskar.
4. Byt alltid alla batterier samtidigt.

- ✓ Specialvertyg finns.
- ✓ Handskar finns.

1. Sätt i specialvertyget i kåpinlägget på elektroniksidan.



2. Böj försiktigt upp kåpinlägget med specialvertyget.



3. Skjut kåpan nedåt.



- ↳ Kåpan är lossad.

4. Avlägsna kåpan.



5. Lossa batterimodulens klämmor med specialvertyget.



6. Avlägsna batterimodulen.



7. Lossa batteriets klämmor med specialvertyget.



8. Ta ur de övre batterierna.



9. Böj mellanfjäders försiktigt åt sidan.

10. Ta ur de nedre batterierna.



11. Sätt i två nya batterier så att pluspolerna vidrör varandra (typ CR2450).



- ↳ Mellanfjäders är synlig ovanför de nedre batterierna.

12. Sätt i två nya batterier så att pluspolerna vidrör varandra (typ CR2450).



13. Haka i batteriklämmorna igen.



14. Sätt tillbaka batterimodulen i modullåren.



15. Haka i batterimodulens klämmor med specialvertyget.



- ↳ SmartHandle AX Advanced piper tre gånger.

16. Sätt på kåpan upp till på fixeringsplattan.



17. Fäll kåpan nedåt.



18. Tryck kåpan mot dörren och skjut den samtidigt uppåt.



- ↳ Kåpan hakar i.

19. Tryck fast inlägget.



- ↳ Batterierna är bytta.

9. Tekniska data

Temperaturområde (drift)	-25 °C till +60 °C
Batterityp	4 × CR2450 3 V litium
Batteritillverkare	<ul style="list-style-type: none"> ■ Murata ■ Panasonic ■ Varta
IP-kapslingsklass	Upp till IP66 (WP-variant)

Utsläpp radio

15,24 kHz - 72,03 kHz Endast för artikelnummer: SV-S3.*AM.G2*, SV-S3.*A.G2*, SI-S3.*LN*	10 dBµA/m (3 m avstånd)
13,560006 MHz - 13,560780 MHz Endast för artikelnummer: SV-S3.*AM.G2*, SV-S3.*A.G2*, SI-S3.*M.WO*, SI-S3.*LN*	1,04 dBµA/m (3 m avstånd)
868,000 MHz - 868,600 MHz / 869,700 MHz - 870,000 MHz Endast för artikelnummer: SI-S3.*M.WO*, SI-S3.*LN*	<25 mW ERP
2402 MHz - 2480 MHz Endast för artikelnummer: SV-S3.*AM.G2*, SV-S3.*A.G2*, SI-S3.*M.WO*, SI-S3.*LN*	2,5 mW

10. Försäkringen om överensstämmelse

Häri förklarar SimonsVoss Technologies GmbH att varan (SI-S3.*M.VCN*, SV-S3.*M.G2*, SV-S3.*AM.G2*, SV-S3.*A.G2*, SI-S3.*M.WO*, SI-S3.*LN*) uppfyller följande riktlinjer:

- 2014/53/EU -RED- eller för Storbritannien: Förenade kungarikets lag 2017 nr 1206 -Radlustrning-
- 2011/65/EU -RoHS- eller för Storbritannien: Förenade kungarikets lag 2012 nr 3032 -RoHS-



Den fullständiga texten till EU-försäkringen om överensstämmelse finns på följande internetadress: www.simons-voss.com/se/certifikat.html.

Den fullständiga texten till UK-försäkringen om överensstämmelse finns på följande internetadress: www.simons-voss.com/se/certifikat.html.

11. Hjälp och ytterligare information

Infomaterial/dokument

<https://www.simons-voss.com/se/dokument.html>

<https://www.smartintego.com/int/home/infocenter/documentation>

Försäkringar om överensstämmelse

<https://www.simons-voss.com/se/certifikat.html>

Avfallshantering

- Produkten (SI-S3.*M.VCN*, SV-S3.*M.G2*, SV-S3.*AM.G2*, SV-S3.*A.G2*, SI-S3.*M.WO*, SI-S3.*LN*) får inte slängas i hushållsoporna utan ska lämnas in på en kommunal uppsamlingsplats för elektriskt och elektroniskt avfall i enlighet med direktiv 2012/19/EU.
- Defekta eller uttjänta batterier ska återvinnas i enlighet med direktiv 2006/66/EG.

- Beakta gällande lokala bestämmelser gällande separat bortskaffande av batterier.
- Avfallshandera förpackningsmaterial på ett miljövänligt sätt.



86

Teknisk support

+49 (0) 89 / 99 228 333

support-simonsvoss@allegion.com

st-support-simonsvoss@allegion.com

FAQ

<https://faq.simons-voss.com/otrs/public.pl>

SimonsVoss Technologies GmbH, Feringastr. 4, D-85774 Unterföhring,
Tyskland

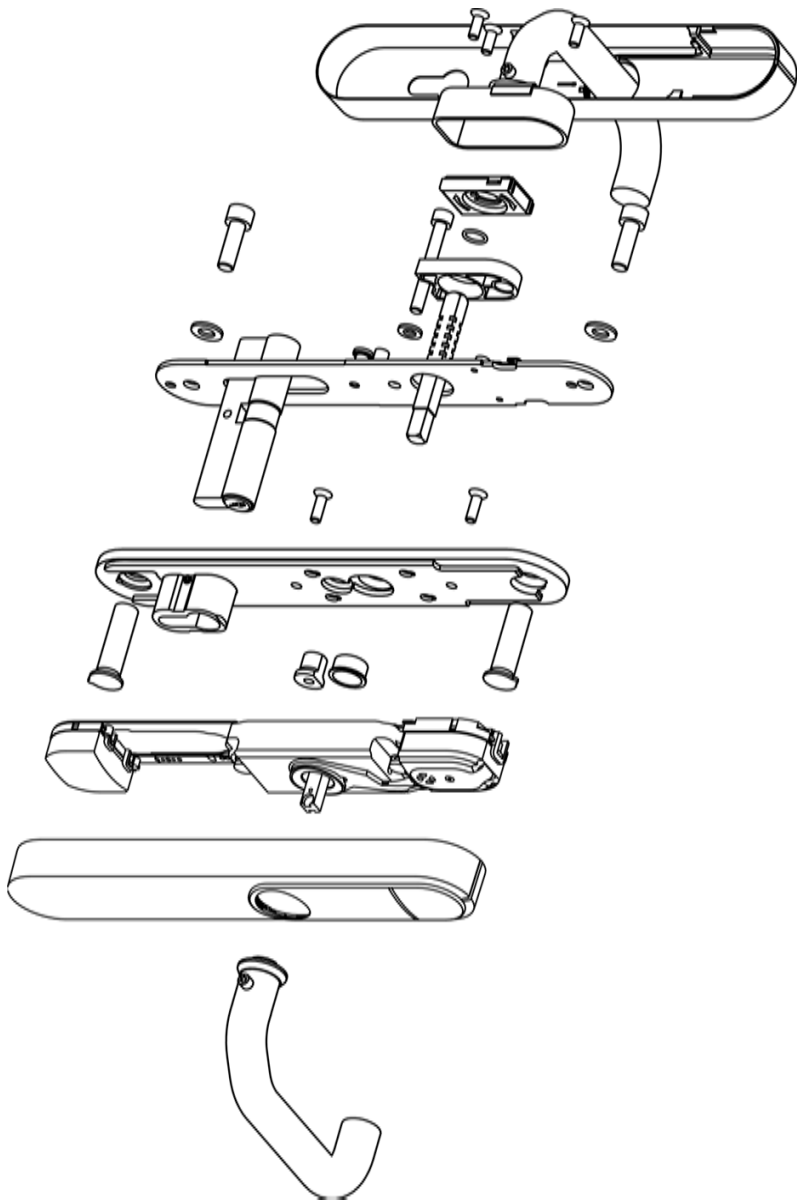

© 2024, SimonsVoss Technologies GmbH, Unterföhring

All rights are reserved. Text, images and diagrams are protected under copyright law.

The content of this document must not be copied, distributed or modified. You can find more information on our website. Subject to technical changes.

SimonsVoss and MobileKey are registered brands belonging to SimonsVoss.

SimonsVoss
technologies

Made in Germany

A BRAND OF

