

30
60

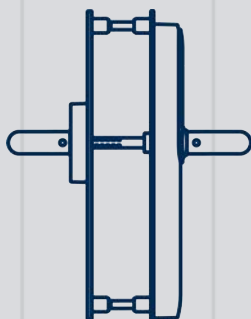

DE Kurzanleitung
EN Quick Guide
FR Guide abrégé
NL Korte handleiding
IT Guida breve
DK Kort vejledning
SE Snabbguide

BS25.990616
11.03.2024



SmartHandle AX Advanced 105/145

Simons  **Voss**
technologies

Abbildungen/Images	3
deutsch	29
english	34
français	39
nederlands	44
italiano	49
dansk	54
svensk	59

4. Structure

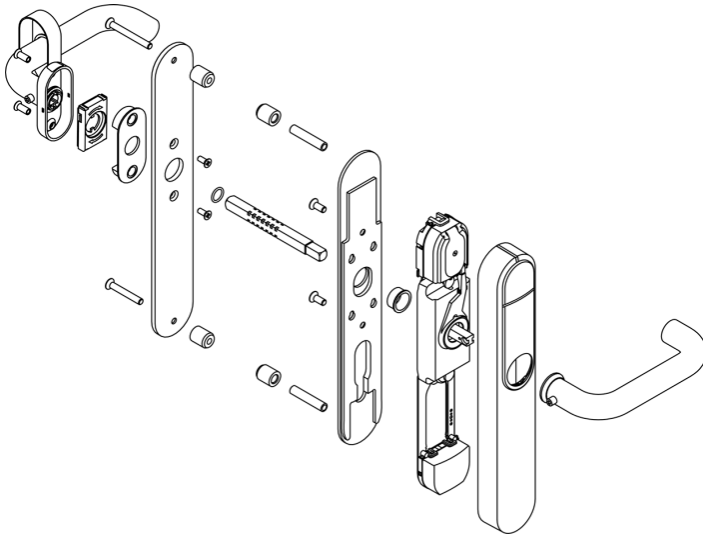

Inside

Outside

5. Prepare door (drilling template)



PH2

Ø8.0

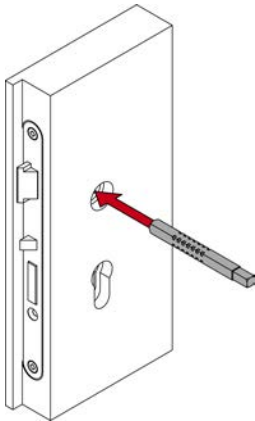

 3

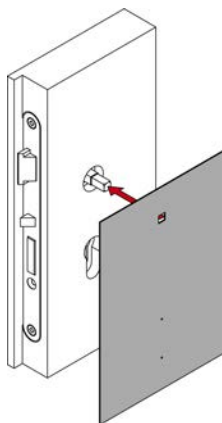

 4

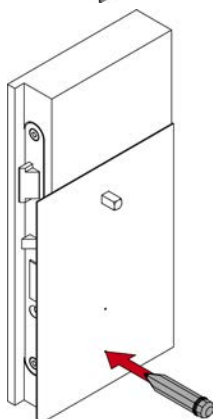

 5

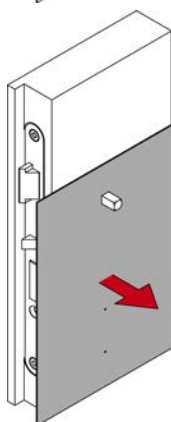

6

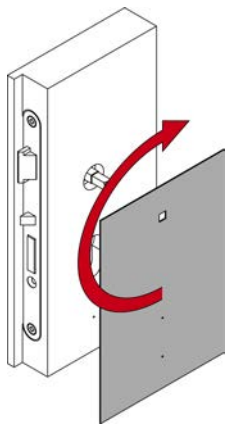

7

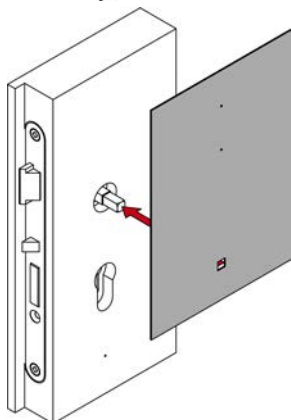

8

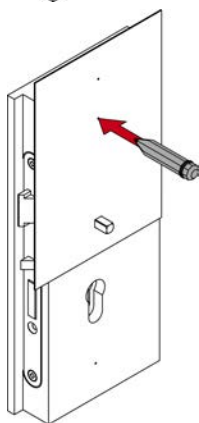

 9

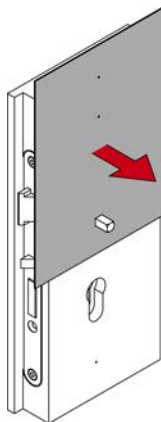

 10

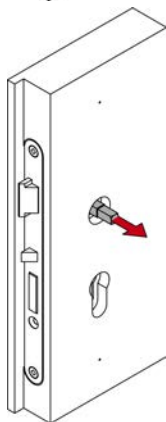

 11



PH2

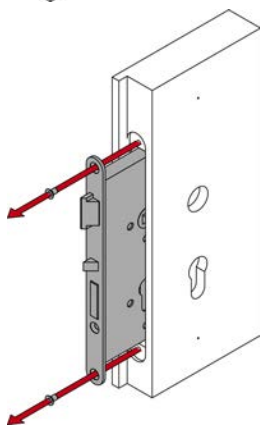

12

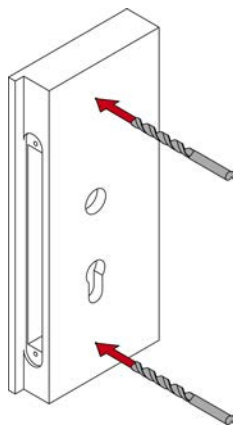
Ø8.0

13

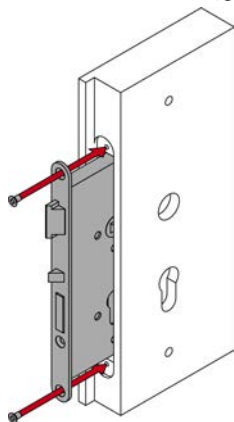

PH2

6. For door thickness X: have the threaded rods and spindle ready at hand

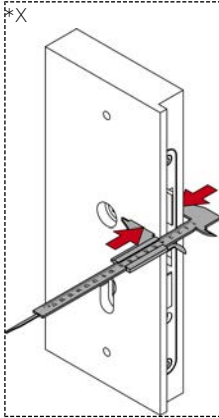

PH2

14



15



PH2

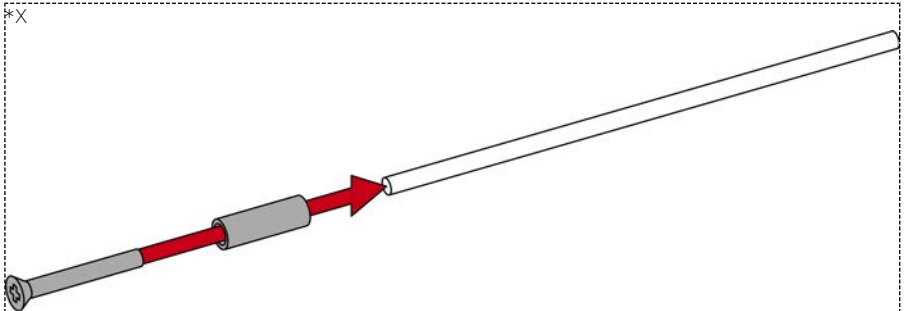

16

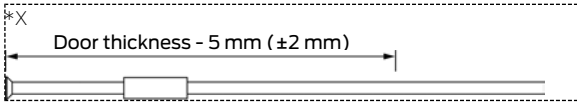

17

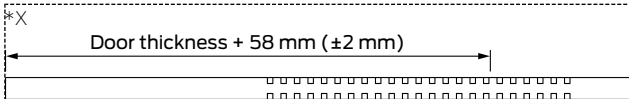

18

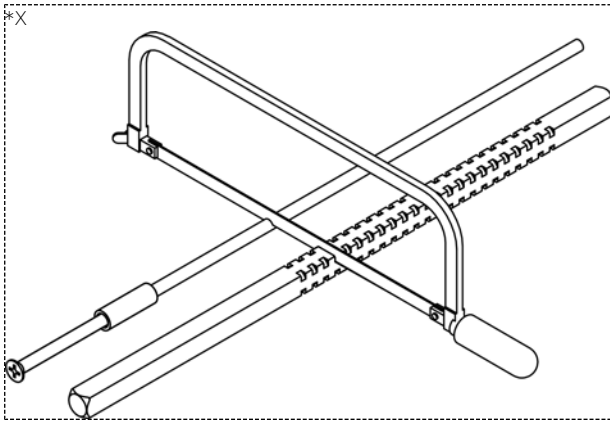

7. Installing the fitting



PH2

SW2.5

TX15

19

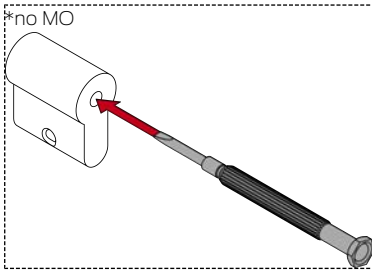

20

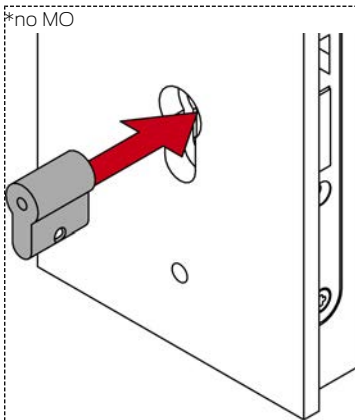

21



PH2

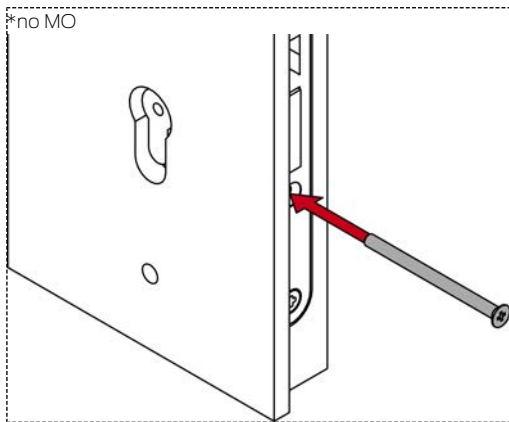

22



23

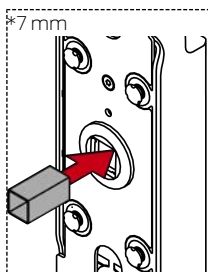

24



25

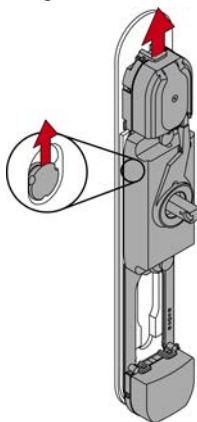

26

M5×12



27



PH2

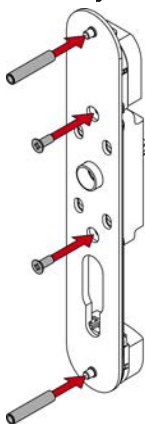

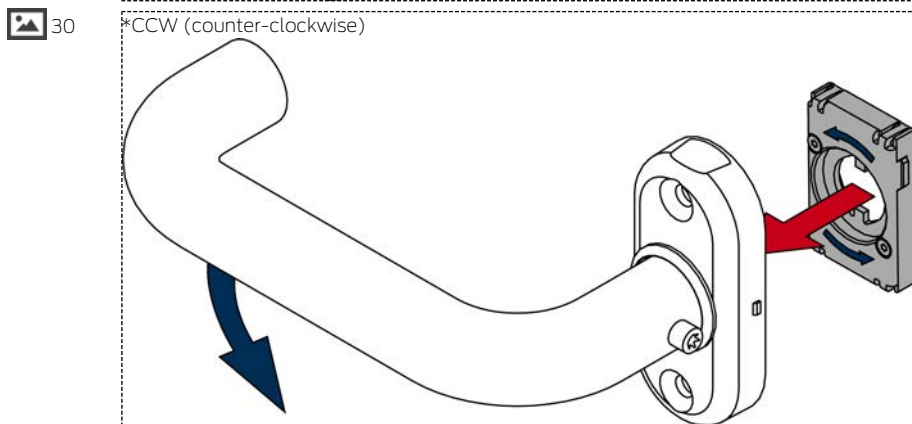
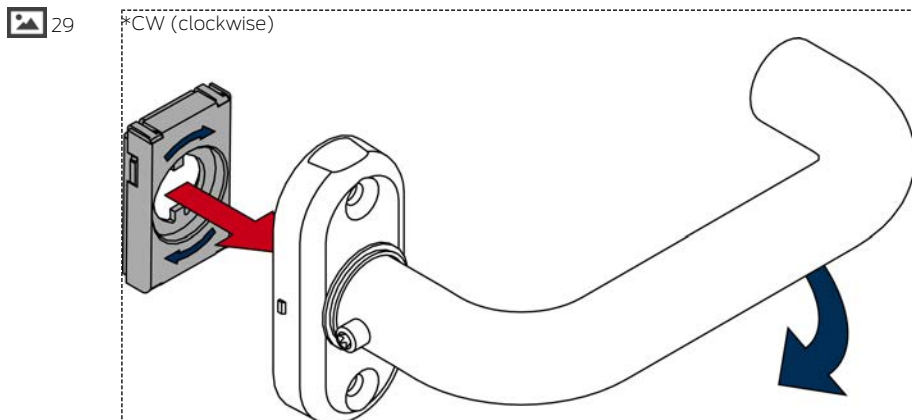
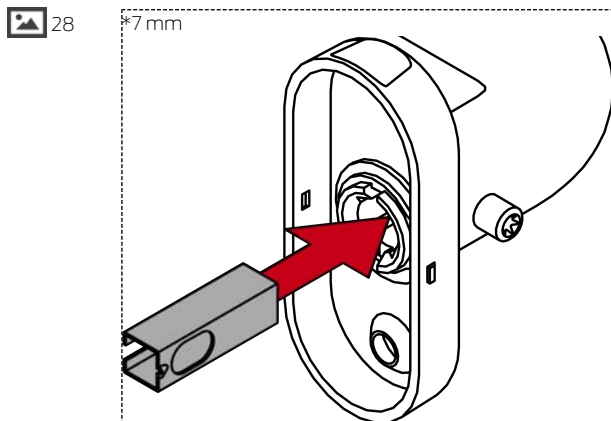

31

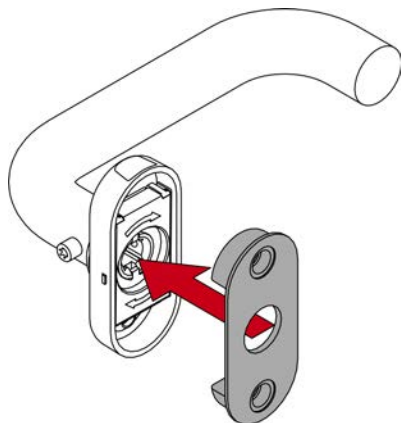

32

M4x10



33



SW2.5



PH2

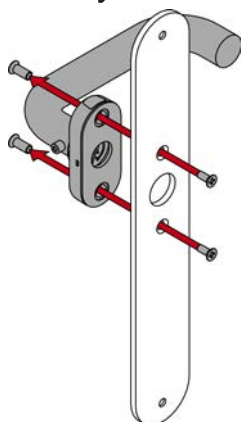

34

*8,5 mm/10 mm

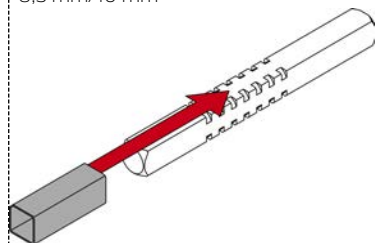

35

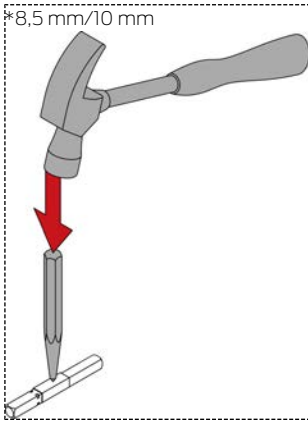

36

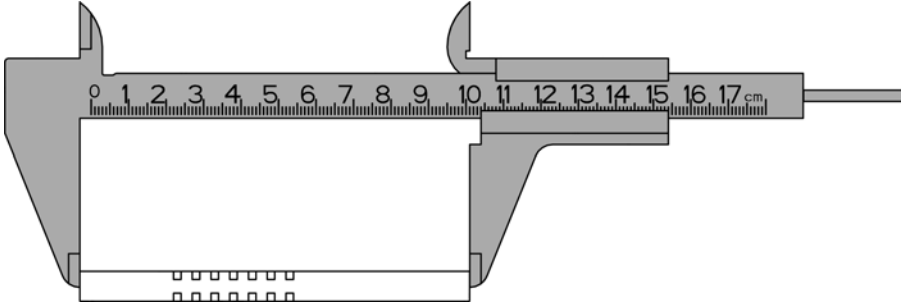

37

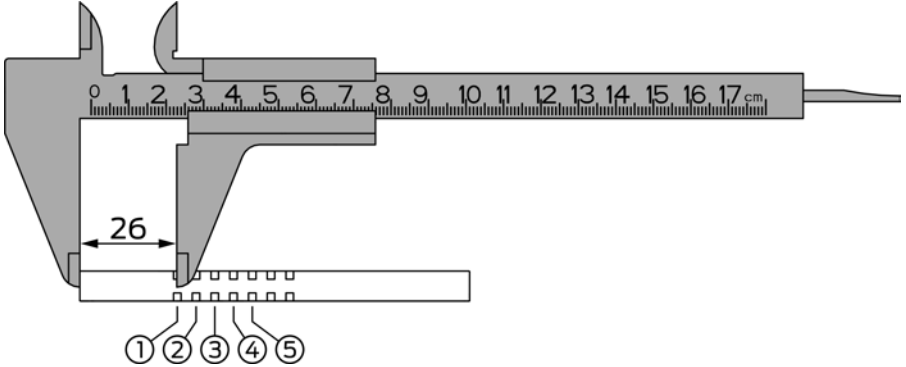

Size	Door thickness (mm)	Spindle length (mm)	Ring position
S	38 – <41	94	2
S	38 – <41	104	4
S	41 – <46	94	1
S	41 – <46	104	3
S	46 – <51	104	2
S	51 – 53	104	1
M	51 – <56	114	3
M	51 – <56	124	5
M	56 – <61	114	2
M	56 – <61	124	4
M	61 – <66	114	1
M	61 – <66	124	3
M	66 – <71	124	2
M	71 – 73	124	1
L	71 – <76	134	3
L	71 – <76	144	5
L	76 – <81	134	2
L	76 – <81	144	4
L	81 – <86	134	1
L	81 – <86	144	3
L	86 – <91	144	2
L	91 – 93	144	1
XL	91 – 176	O-ring is located 30–35 mm from the cut end of the spindle.	



38

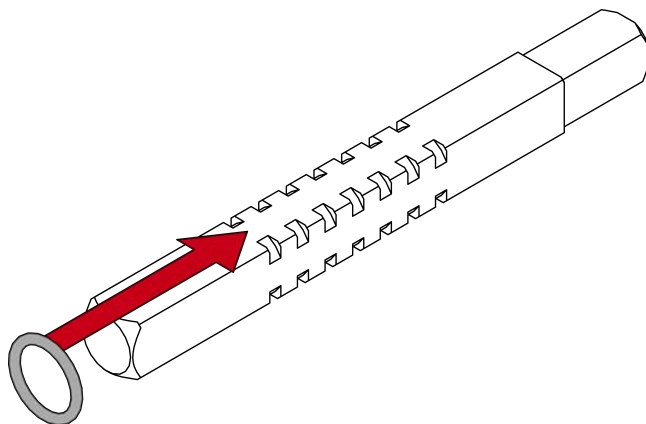

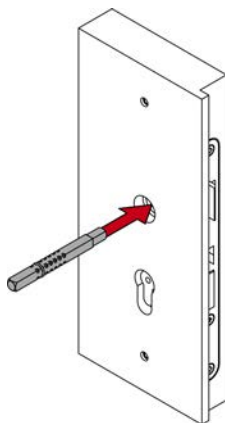
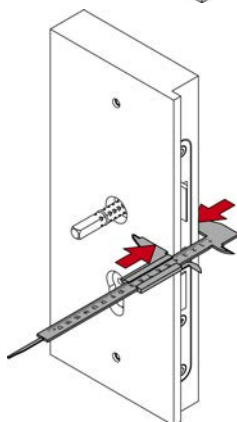
 39

 40

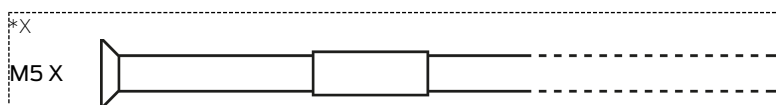
Size	Door thickness (mm)	Screws
S	38 – 53	M5×35
M	51 – 63	M5×40
M	62 – 73	M5×50
L	71 – 83	M5×60
L	82 – 93	M5×70
X	91 – 176	M5 X

 41

42



PH2

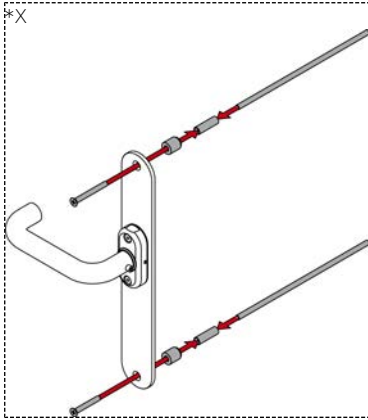

43

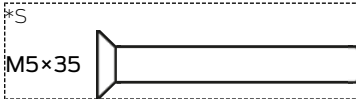

44

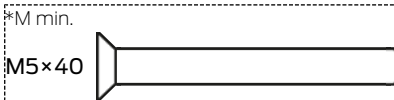

45

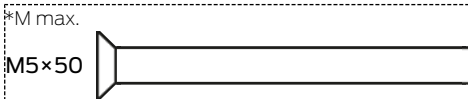

46

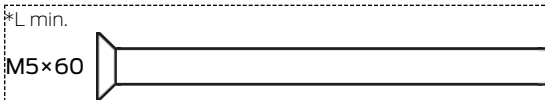

47

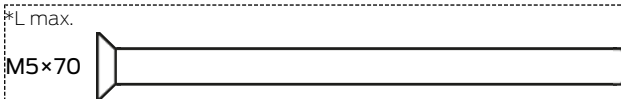

48



PH2

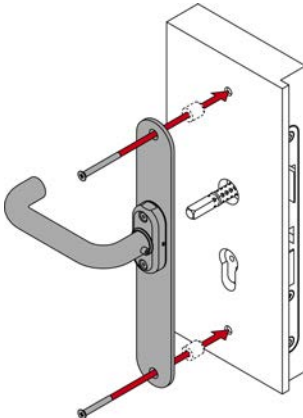

49



TX15

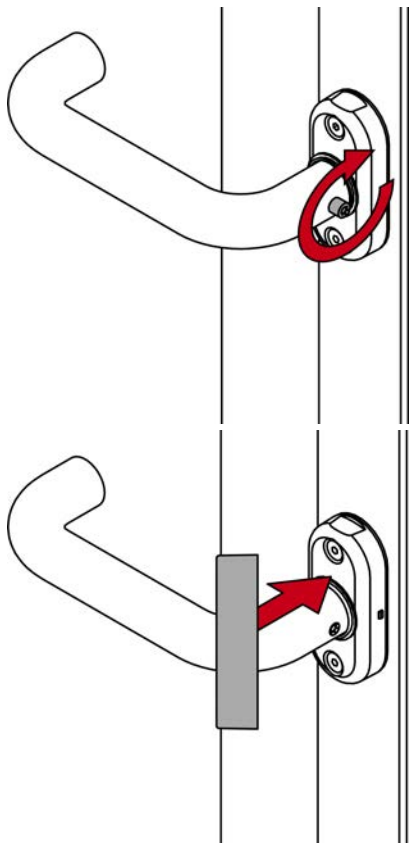

50

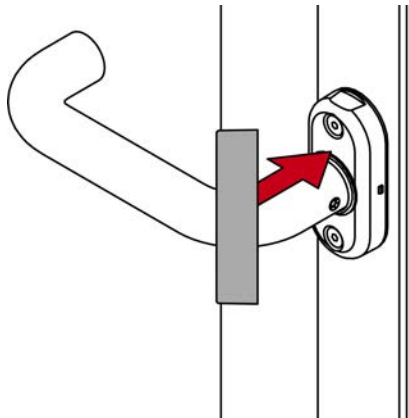

51

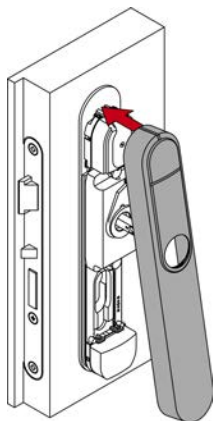

52

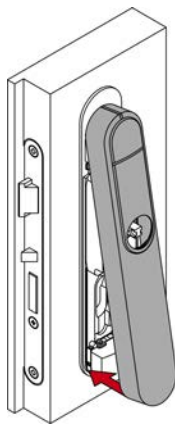

53

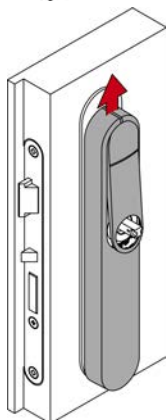

54



 55

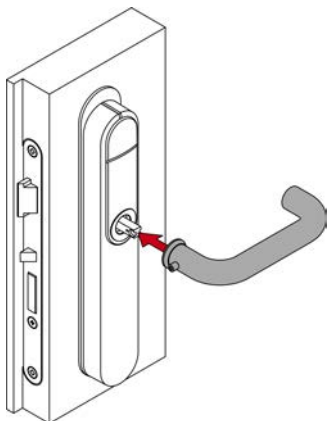

 56



TX15

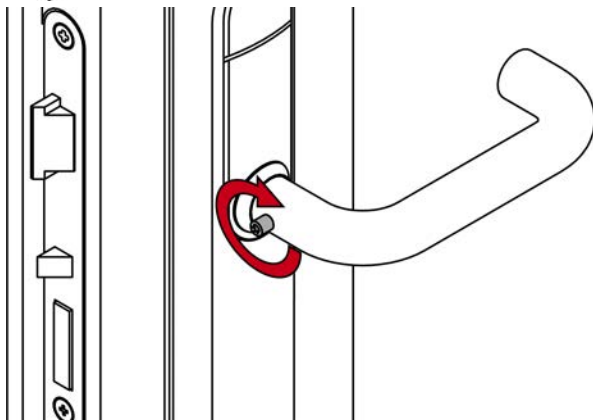

 57

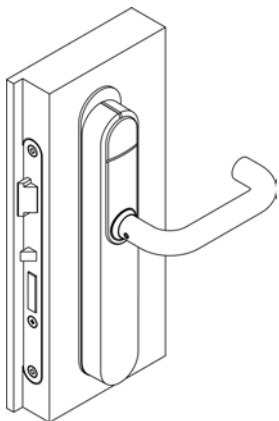

8. Removing the fitting (105/145)



SW1.5



58



SW1.5

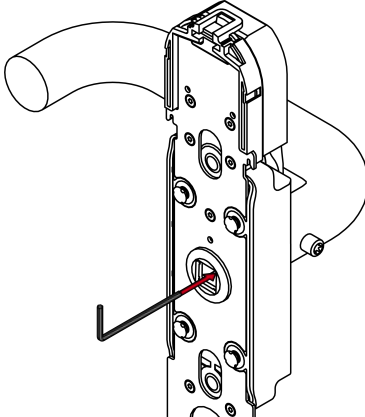

59



SW1.5

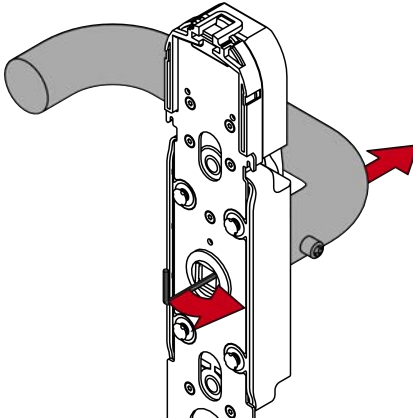

9. Replacing the batteries



 60

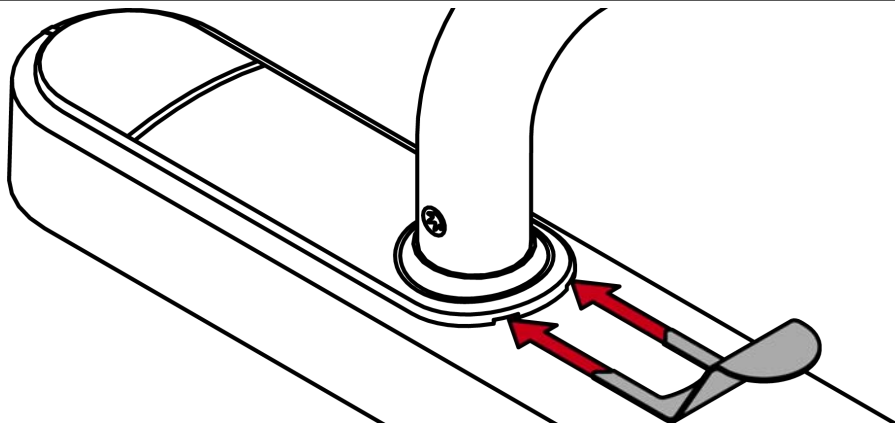

 61

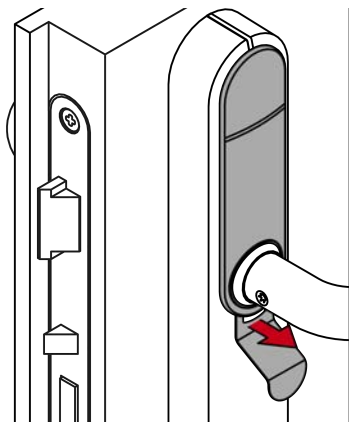

62

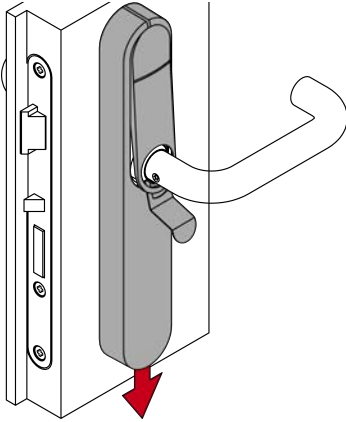

63

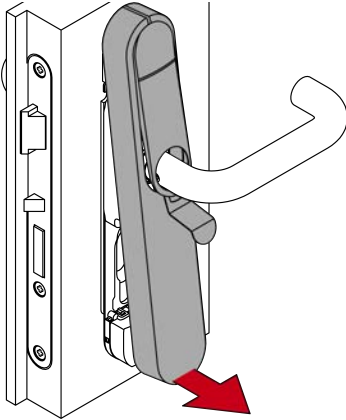

64

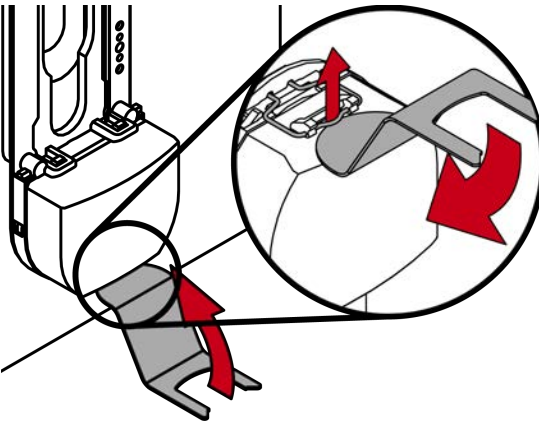

 65

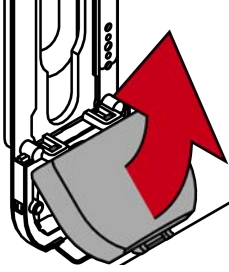

 66

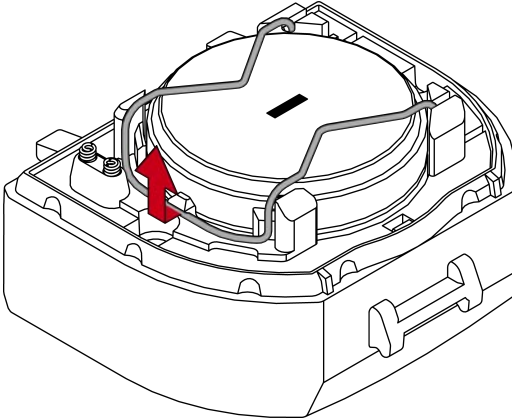

 67

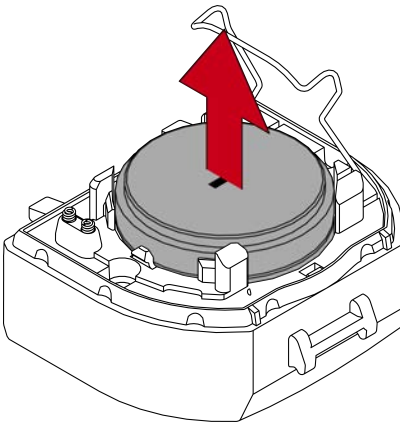

68

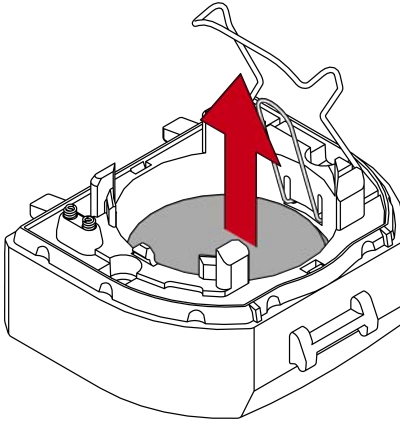

69

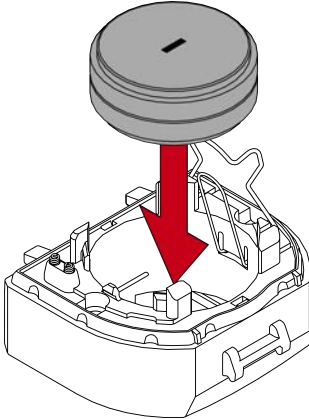

70

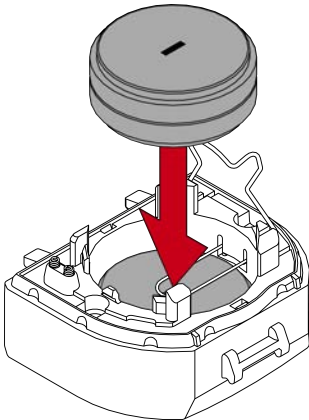

 71

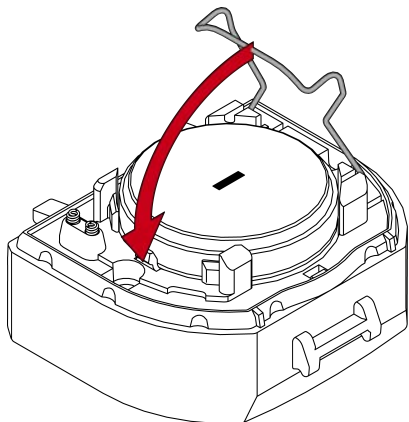

 72

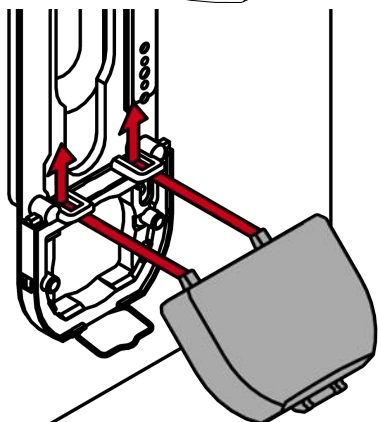

 73

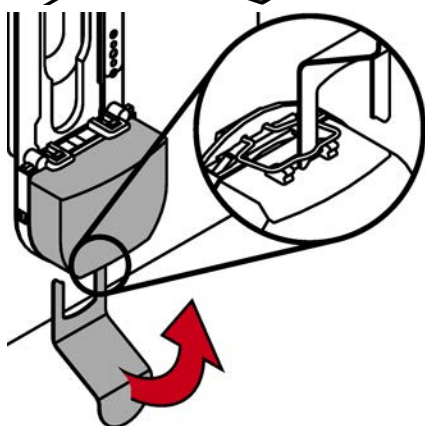

74

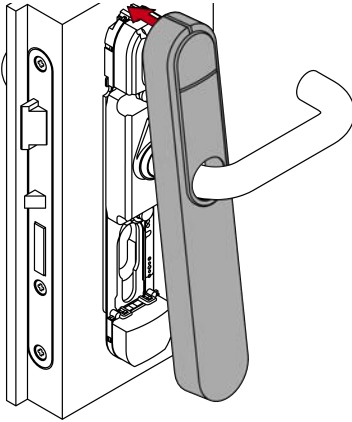

75

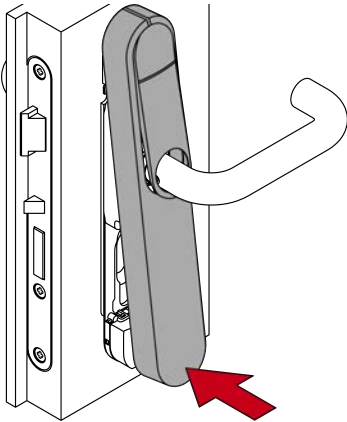

76

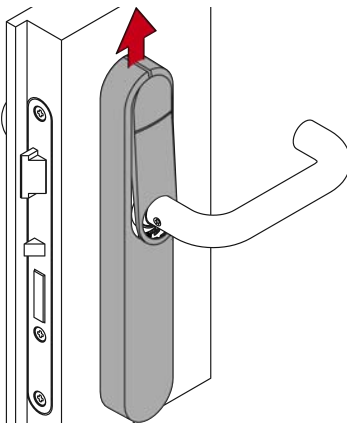



77

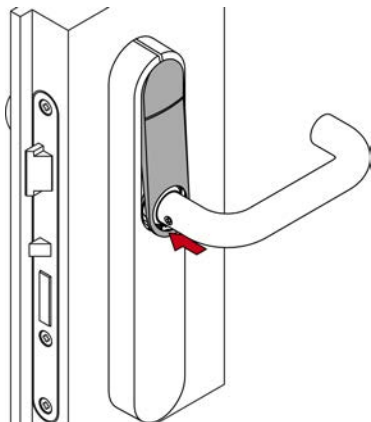

12. Help and other information



78



1. Allgemeine Sicherheitshinweise

Signalwort: Mögliche unmittelbare Auswirkungen bei Nichtbeachtung

WARNUNG: Tod oder schwere Verletzung (möglich, aber unwahrscheinlich), **VORSICHT:** Leichte Verletzung, **ACHTUNG:** Sachschäden oder Fehlfunktionen, **HINWEIS:** Geringe oder keine



WARNUNG

Versperrter Zugang

Durch fehlerhaft montierte und/oder programmierte Komponenten kann der Zutritt durch eine Tür versperrt bleiben. Für Folgen eines versperrten Zutritts wie Zugang zu verletzten oder gefährdeten Personen, Sachschäden oder anderen Schäden haftet die SimonsVoss Technologies GmbH nicht!

Versperrter Zugang durch Manipulation des Produkts

Wenn Sie das Produkt eigenmächtig verändern, dann können Fehlfunktionen auftreten und der Zugang durch eine Tür versperrt werden.

- Verändern Sie das Produkt nur bei Bedarf und nur in der Dokumentation beschriebenen Art und Weise.

Batterie nicht einnehmen. Verbrennungsgefahr durch gefährliche Stoffe

Dieses Produkt enthält Lithium-Knopfzellen. Wenn die Knopfzelle verschluckt wird, können schwere innere Verbrennungen innerhalb von gerade einmal zwei Stunden auftreten und zum Tode führen.

1. Halten Sie neue und gebrauchte Batterien von Kindern fern.
2. Wenn das Batteriefach nicht sicher schließt, dann benutzen Sie das Produkt nicht mehr und halten Sie es von Kindern fern.
3. Wenn Sie meinen, dass Batterien verschluckt wurden oder sich in irgendeinem Körperteil befinden, suchen Sie unverzüglich medizinische Hilfe auf.

Explosionsgefahr durch falschen Batterietyp

Das Einsetzen falscher Batterietypen kann zu einer Explosion führen.

- Verwenden Sie ausschließlich die in den technischen Daten spezifizierten Batterien.



VORSICHT

Feuergefahr durch Batterien

Die eingesetzten Batterien können bei Fehlbehandlung eine Feuer- oder Verbrennungsgefahr darstellen.

1. Versuchen Sie nicht, die Batterien aufzuladen, zu öffnen, zu erhitzen oder zu verbrennen.
2. Schließen Sie die Batterien nicht kurz.

ACHTUNG

Beschädigung durch elektrostatische Entladung (ESD) bei geöffnetem Gehäuse

Dieses Produkt enthält elektronische Bauteile, die durch elektrostatische Entladungen beschädigt werden können.

1. Verwenden Sie ESD-gerechte Arbeitsmaterialien (z.B. Erdungsarmband).
2. Erden Sie sich vor Arbeiten, bei denen Sie mit der Elektronik in Kontakt kommen könnten. Fassen Sie dazu geerdete metallische Oberflächen an (z.B. Türzargen, Wasserrohre oder Heizungsventile).

Beschädigung durch Öle, Fette, Farben und Säuren

Dieses Produkt enthält elektronische und/oder mechanische Bauteile, die durch Flüssigkeiten aller Art beschädigt werden können.

- Halten Sie Öle, Fette, Farben und Säuren vom Produkt fern.

Beschädigung durch aggressive Reinigungsmittel

Die Oberfläche dieses Produkts kann durch ungeeignete Reinigungsmittel beschädigt werden.

- Verwenden Sie ausschließlich Reinigungsmittel, die für Kunststoff- bzw. Metalloberflächen geeignet sind.

Beschädigung durch mechanische Einwirkung

Dieses Produkt enthält elektronische Bauteile, die durch mechanische Einwirkung aller Art beschädigt werden können.

1. Vermeiden Sie das Anfassen der Elektronik.
2. Vermeiden Sie sonstige mechanische Einwirkungen auf die Elektronik.

Beschädigung durch Verpolung

Dieses Produkt enthält elektronische Bauteile, die durch die Verpolung der Spannungsquelle beschädigt werden können.

- Verpolen Sie die Spannungsquelle nicht (Batterien bzw. Netzteile).

Störung des Betriebs durch Funkstörung

Dieses Produkt kann unter Umständen durch elektromagnetische oder magnetische Störungen beeinflusst werden.

- Montieren bzw. platzieren Sie das Produkt nicht unmittelbar neben Geräten, die elektromagnetische oder magnetische Störungen verursachen können (Schaltnetzteile!).

Störung der Kommunikation durch metallische Oberflächen

Dieses Produkt kommuniziert drahtlos. Metallische Oberflächen können die Reichweite des Produkts erheblich reduzieren.

- Montieren bzw. platzieren Sie das Produkt nicht auf oder in der Nähe von metallischen Oberflächen.



HINWEIS

Bestimmungsgemäßer Gebrauch

SimonsVoss-Produkte sind ausschließlich für das Öffnen und Schließen von Türen und vergleichbaren Gegenständen bestimmt.

- Verwenden Sie SimonsVoss-Produkte nicht für andere Zwecke.

Funktionsstörungen durch schlechten Kontakt oder unterschiedliche Entladung

Zu kleine/verunreinigte Kontaktflächen oder unterschiedliche entladene Batterien können zu Funktionsstörungen führen.

1. Verwenden Sie nur Batterien, die von SimonsVoss freigegeben sind.
2. Berühren Sie die Kontakte der neuen Batterien nicht mit den Händen.
3. Verwenden Sie saubere und fettfreie Handschuhe.
4. Tauschen Sie immer alle Batterien gleichzeitig aus.

Abweichende Zeiten bei G2-Schließungen

Die interne Zeit Einheit der G2-Schließungen hat eine technisch bedingte Toleranz von bis zu ± 15 Minuten pro Jahr.

Qualifikationen erforderlich

Die Installation und Inbetriebnahme setzt Fachkenntnisse voraus.

- Nur geschultes Fachpersonal darf das Produkt installieren und in Betrieb nehmen.

Änderungen bzw. technische Weiterentwicklungen können nicht ausgeschlossen und ohne Ankündigung umgesetzt werden.

Die deutsche Sprachfassung ist die Originalbetriebsanleitung. Andere Sprachen (Abfassung in der Vertragssprache) sind Übersetzungen der Originalbetriebsanleitung.

Lesen Sie alle Anweisungen zur Installation, zum Einbau und zur Inbetriebnahme und befolgen Sie diese. Geben Sie diese Anweisungen und jegliche Anweisungen zur Wartung an den Benutzer weiter.

2. Produktspezifische Sicherheitshinweise

ACHTUNG

Erschwerte Montage durch herausgedrückte Gewindehülsen

Die Gewindehülsen im Beschlag sind mit einer Presspassung montiert. Übermäßiges Drücken beim Festschrauben des Beschlags auf der Fixierplatte kann dazu führen, dass die Gewindehülsen aus dem Beschlag rutschen.

1. Drücken Sie beim Verschrauben des Modulträgers nicht auf die Schrauben.
2. Verwenden Sie einen Finger an den Enden Gewindehülsen, um während des Verschraubens gegenzuhalten.

3. Lieferumfang

■ SmartHandle AX Advanced für die konventionelle Montage 105/145.

■ Spezialwerkzeug

■ Kurzanleitung

Je nach Variante:

■ Adaptersatz 7-mm-Vierkant

■ Adapterhülse 8,5-mm-Vierkant

■ Adapterhülse 10-mm-Vierkant

4. Aufbau



5. Tür vorbereiten (Bohrschablone)

- ✓ Stift oder Anreißnadel vorhanden.
- ✓ Bohrmaschine vorhanden.
- ✓ Geeigneter Bohrer vorhanden (Ø 7 mm).
- ✓ PH2-Schraubendreher vorhanden.

1. Stecken Sie den Vierkant in das Einsteckschloss.



2. Stecken Sie die Bohrschablone auf den Vierkant.



3. Richten Sie die Bohrschablone mithilfe der aufgedruckten Skala senkrecht aus.

4. Markieren Sie die Bohrlöcher mit der Markierung 1.



5. Entfernen Sie die Bohrschablone und drehen Sie sie um 180 Grad.



6. Stecken Sie die Bohrschablone auf den Vierkant.



7. Richten Sie die Bohrschablone mithilfe der aufgedruckten Skala senkrecht aus.



8. Markieren Sie das Bohrloch mit der Markierung 2.



9. Entfernen Sie die Bohrschablone und den Vierkant.



10. Bauen Sie das Einsteckschloss aus.



11. Bohren Sie die benötigten Löcher.



12. Bauen Sie das Einsteckschloss ein.



13. Bauen Sie das Einsteckschloss ein.

6. Für Türdicke X: Gewindestangen und Vierkant vorbereiten

- ✓ Messschieber vorhanden.
- ✓ Säge vorhanden.
- ✓ PH2-Schraubendreher vorhanden.

1. Messen Sie die Türdicke.



2. Für Türdicke X: Schrauben Sie die 50-mm-Schrauben, die Gewindehülsen und die Gewindestangen zusammen.



3. Für X: Markieren Sie die Sägestellen an den Gewindestangen und am Vierkant.



4. Für X: Kürzen Sie mit einer geeigneten Säge die Gewindestangen und den Vierkant.



7. Beschlag montieren

- ✓ Tür vorgebohrt.
- ✓ PH2-Schraubendreher vorhanden.
- ✓ TX15-Schraubendreher vorhanden.
- ✓ Messschieber vorhanden.

1. Für Nicht-MO: Setzen Sie den Blindzylinder ein.



HINWEIS

Blindzylinder mit Schraubendreher im Loch führen

Insbesondere bei dicken Türen ist es schwierig, den Blindzylinder richtig zu positionieren.

1. Stecken Sie einen Schraubendreher in das Loch des Blindzylinders.
2. Positionieren Sie den Blindzylinder mithilfe des Schraubendrehers.



19. Für Nicht-MO: Schrauben Sie den Blindzylinder fest.



20. Setzen Sie das Vierkant-Schutzröhrchen in die Fixierplatte ein.



21. Für 7-mm-Vierkant: Setzen Sie den Adapterschuh in die Vierkant-Aufnahme des Modulträgers.



22. Stecken Sie den Modulträger in die Fixierplatte.



23. Schieben Sie den Modulträger nach oben.



24. Modulträger rastet ein.

25. Schrauben Sie die Gewindehülsen auf die Gewindebolzen der Fixierplatte.



26. Schrauben Sie mit den 12-mm-Schrauben den Modulträger an der Fixierplatte fest (PH2).













27. Stecken Sie den Modulträger mit der Fixierplatte in die Tür-Außenseite.





**HINWEIS****Reduzierhülsen für vorhandene 14-mm-Bohrungen**



Bereits vorhandene 14-mm-Bohrungen erschweren die sichere Befestigung des SmartHandle AX Advanced.

- Stecken Sie die mitgelieferten Silikon-Reduzierhülsen in die vorhandenen Bohrungen, um das Spiel zu verringern.
10. Für 7-mm-Vierkant: Setzen Sie die Adapterhülse so in den Innendrücker, dass die Aussparung zur Madenschraube zeigt.
 -  28
 11. Bestimmen Sie die gewünschte Drehrichtung Ihres Innendrückers.
 12. Setzen Sie das Federelement entsprechend ein.
 -  29
 -  30
 13. Setzen Sie die Unterlage in die Innendrücker-Einheit.
 -  31
 14. Schrauben Sie den Innendrücker zusammen mit den Gewindehülsen und den 10-mm-Schrauben an die Fixierplatte (2,5-mm-Sechskantschlüssel und PH2).
 -  32
 -  33
 15. Für 8,5-mm- und 10-mm-Vierkant: Schieben Sie die Adapterhülse in die Mitte des Vierkants. Machen Sie mit Körner und Hammer eine Vertiefung in die Adapterhülse, um das Verrutschen zu verhindern.
 -  34
 -  35
 16. Messen Sie die Gesamtlänge des Vierkants.
 -  36
 17. Ermitteln Sie die Innenseite des Vierkants (Vierkantende bis Mitte erster Rille = 26 mm).
 18. Bestimmen Sie die Position des O-Rings mit der Tabelle.
 -  37

Bereich	Türdicke (mm)	Vierkantlänge (mm)	Ringposition
S	38 - <41	94	2
S	38 - <41	104	4
S	41 - <46	94	1
S	41 - <46	104	3
S	46 - <51	104	2
S	51 - 53	104	1
M	51 - <56	114	3
M	51 - <56	124	5
M	56 - <61	114	2
M	56 - <61	124	4
M	61 - <66	114	1
M	61 - <66	124	3
M	66 - <71	124	2
M	71 - 73	124	1
L	71 - <76	134	3
L	71 - <76	144	5
L	76 - <81	134	2
L	76 - <81	144	4
L	81 - <86	134	1
L	81 - <86	144	3
L	86 - <91	144	2
L	91 - 93	144	1
XL	91 - 176	O-Ring liegt 30-35 mm vom abgesägten Ende des Vierkants.	

19. Schieben Sie den O-Ring auf die berechnete Rille.
 -  38
20. Stecken Sie den Vierkant mit der ringfreien Seite bis zum Anschlag in die Tür.
 -  39
21. Messen Sie die Türdicke.
 -  40

Bereich	Türdicke (mm)	Schrauben
S	38 - 53	M5×35
M	51 - 63	M5×40
M	62 - 73	M5×50
L	71 - 83	M5×60
L	82 - 93	M5×70
X	91 - 176	M5 X

22. Bestimmen Sie mit der gemessenen Türdicke die benötigten Schrauben.
23. Für X: Stecken Sie die Schrauben durch die innenseitige Fixierplatte und schrauben Sie sie mit der Gewindemuffe und der Gewindestange zusammen.
 -  41
 -  42
24. Verschrauben Sie mit den ermittelten Schrauben den Innenteil und den Außenteil (PH2).

**HINWEIS****Reduzierhülsen für vorhandene 14-mm-Bohrungen**

Bereits vorhandene 14-mm-Bohrungen erschweren die sichere Befestigung des SmartHandle AX Advanced.

- Stecken Sie die mitgelieferten Silikon-Reduzierhülsen in die vorhandenen Bohrungen, um das Spiel zu verringern.



43



44



45



46



47



48

25. Schrauben Sie die Madenschraube des Innendrückers fest (TX15).



49

26. Stecken Sie eine Blende mit der Einkerbung nach unten auf die Basis des Innendrückers.



50

27. Setzen Sie das Cover oben auf der Fixierplatte an.



51

28. Klappen Sie das Cover nach unten zu.



52

29. Schieben Sie das Cover nach oben.



53

30. Drücken Sie das Inlay fest.



54

31. Stecken Sie den Außendrücker auf.



55

32. Schrauben Sie mit der Madenschraube den Außendrücker fest (TX15).



56

- ↳ SmartHandle AX Advanced fertig montiert.



57

8. Beschlag demontieren (105/145)

- ✓ 1,5-mm-Sechskantschlüssel vorhanden.

1. Demontieren Sie den Beschlag in umgekehrter Reihenfolge zur Montage.
2. Lösen Sie dabei das Cover, indem Sie mit dem Spezialwerkzeug das Inlay nach außen biegen.
3. Stecken Sie einen 1,5-mm-Sechskantschlüssel in das Loch der Vierkant-aufnahme im Modulträger.



58

4. Biegen Sie den Sechskantschlüssel auf die Seite, auf der sich das Loch befindet und ziehen Sie gleichzeitig am Außendrücker.



59

- ↳ SmartHandle AX Advanced ist demontiert.

9. Batterien wechseln**HINWEIS****Funktionsstörungen durch schlechten Kontakt oder unterschiedliche Entladung**

Zu kleine/verunreinigte Kontaktf lächen oder unterschiedliche entladene Batterien können zu Funktionsstörungen führen.

1. Verwenden Sie nur Batterien, die von SimonsVoss freigegeben sind.
2. Berühren Sie die Kontakte der neuen Batterien nicht mit den Händen.
3. Verwenden Sie saubere und fettfreie Handschuhe.
4. Tauschen Sie immer alle Batterien gleichzeitig aus.

- ✓ Spezialwerkzeug vorhanden.
- ✓ Handschuhe vorhanden.

1. Stecken Sie das Spezialwerkzeug in das Cover-Inlay der Elektronikseite.



60

2. Biegen Sie mit dem Spezialwerkzeug das Cover-Inlay vorsichtig auf.



61

3. Schieben Sie das Cover nach unten.



62

- ↳ Cover entriegelt.

4. Nehmen Sie das Cover ab.



63

5. Haken Sie mit dem Spezialwerkzeug die Klammer des Batteriemoduls aus.



64

6. Nehmen Sie das Batteriemodul ab.



65

7. Haken Sie mit dem Spezialwerkzeug die Batterie-Klammer aus.



66

8. Entnehmen Sie die oberen Batterien.



67

9. Biegen Sie die Zwischenfeder vorsichtig zur Seite.

10. Entnehmen Sie die unteren Batterien.



68

11. Setzen Sie zwei neue Batterien mit sich berührenden Pluspolen ein (Typ CR2450).



69

- ↳ Zwischenfeder sichtbar oberhalb der unteren Batterien.

12. Setzen Sie zwei neue Batterien mit sich berührenden Pluspolen ein (Typ CR2450).



70

13. Haken Sie die Batterie-Klammer wieder ein.



71

14. Setzen Sie das Batteriemodul wieder in den Modulträger ein.



72

15. Haken Sie mit dem Spezialwerkzeug die Klammer des Batteriemoduls wieder ein.



73

- ↳ SmartHandle AX Advanced piept dreimal.

16. Setzen Sie das Cover oben auf der Fixierplatte an.



74

17. Klappen Sie das Cover nach unten zu.



75

18. Drücken Sie das Cover gegen die Tür und schieben Sie es gleichzeitig nach oben.



76

↳ Cover rastet ein.

19. Drücken Sie das Inlay fest.



77

- ↳ Batterien sind gewechselt.

- Beachten Sie örtliche Bestimmungen zur getrennten Entsorgung von Batterien.
- Führen Sie die Verpackung einer umweltgerechten Wiederverwertung zu.



78

Technischer Support

+49 (0) 89 / 99 228 333

E-Mail

support-simonsvoss@allegion.com

si-support-simonsvoss@allegion.com

FAQ

<https://faq.simons-voss.com/otrs/public.pl>

SimonsVoss Technologies GmbH, Feringastr. 4, D-85774 Unterföhring, Deutschland

10. Technische Daten

Temperaturbereich (Betrieb)	-25 °C bis +60 °C
Batterietyp	4 × CR2450 3V Lithium
Batteriehersteller	<ul style="list-style-type: none"> ■ Murata ■ Panasonic ■ Varta
IP-Schutzklasse	Bis zu IP66 (WP-Variante)

Funkemissionen

15,24 kHz - 72,03 kHz Nur für Artikelnummern: SV-S3.*AM.G2*, SV-S3.*A.G2*, SI-S3.*LN*	10 dBµA/m (3 m Entfernung)
13,560006 MHz - 13,560780 MHz Nur für Artikelnummern: SV-S3.*AM.G2*, SV-S3.*A.G2*, SI-S3.*M.WO*, SI-S3.*LN*	1,04 dBµA/m (3 m Entfernung)
868,000 MHz - 868,600 MHz / 869,700 MHz - 870,000 MHz Nur für Artikelnummern: SI-S3.*M.WO*, SI-S3.*LN*	<25 mW ERP
2402 MHz - 2480 MHz Nur für Artikelnummern: SV-S3.*AM.G2*, SV-S3.*A.G2*, SI-S3.*M.WO*, SI-S3.*LN*	2,5 mW

11. Konformitätserklärung

Hiermit erklärt die SimonsVoss Technologies GmbH, dass die Artikel (SI-S3.*M.VCN*, SV-S3.*M.G2*, SV-S3.*AM.G2*, SV-S3.*A.G2*, SI-S3.*M.WO*, SI-S3.*LN*) folgenden Richtlinien entsprechen:

- 2014/53/EU – Funkanlagen- bzw. für UK: Rechtsverordnung 2017 Nr. 1206 – Funkanlagen-
- 2011/65/EU – RoHS- bzw. für UK: Rechtsverordnung 2012 Nr. 3032 – RoHS-



Der vollständige Text der EU-Konformitätserklärung ist unter der folgenden Internetadresse verfügbar: www.simons-voss.com/de/zertifikate.html.

Der vollständige Text der UK-Konformitätserklärung ist unter der folgenden Internetadresse verfügbar: www.simons-voss.com/de/zertifikate.html.

12. Hilfe und weitere Informationen

Infomaterial/Dokumente

<https://www.simons-voss.com/de/dokumente.html>

<https://www.smartintego.com/de/home/infocenter/dokumentation>

Konformitätserklärungen und Zertifikate

<https://www.simons-voss.com/de/zertifikate.html>

Informationen zur Entsorgung

- Entsorgen Sie das Gerät (SI-S3.*M.VCN*, SV-S3.*M.G2*, SV-S3.*AM.G2*, SV-S3.*A.G2*, SI-S3.*M.WO*, SI-S3.*LN*) nicht mit dem Hausmüll, sondern gemäß der europäischen Richtlinie 2012/19/EU bei einer kommunalen Sammelstelle für Elektro-Sonderabfälle.
- Recyceln Sie defekte oder verbrauchte Batterien gemäß der europäischen Richtlinie 2006/66/EG.

1. General safety instructions

Signal word: Possible immediate effects of non-compliance

WARNING: Death or serious injury (possible, but unlikely), CAUTION: Minor injury, IMPORTANT: Property damage or malfunction, NOTE: Low or none



WARNING

Blocked access

Access through a door may stay blocked due to incorrectly fitted and/or incorrectly programmed components. SimonsVoss Technologies GmbH is not liable for the consequences of blocked access such as access to injured or endangered persons, material damage or other damage!

Blocked access through manipulation of the product

If you change the product on your own, malfunctions can occur and access through a door can be blocked.

- Modify the product only when needed and only in the manner described in the documentation.

Do not swallow battery. Danger of burns from hazardous substances

This product contains lithium button cell batteries. Swallowing the button cell battery, in can result in severe internal burns leading to death in as little as two hours.

1. Keep new and used batteries away from children.
2. If the battery compartment does not close securely, cease using the product and keep it away from children.
3. If you think batteries have been swallowed or are in any part of the body, seek medical attention immediately.

Risk of explosion due to incorrect battery type

Inserting the wrong type of battery can cause an explosion.

- Only use the batteries specified in the technical data.



CAUTION

Fire hazard posed by batteries

The batteries used may pose a fire or burn hazard if handled incorrectly.

1. Do not try to charge, open, heat or burn the batteries.
2. Do not short-circuit the batteries.

IMPORTANT

Damage resulting from electrostatic discharge (ESD) when enclosure is open

This product contains electronic components that may be damaged by electrostatic discharges.

1. Use ESD-compliant working materials (e.g. Grounding strap).
2. Ground yourself before carrying out any work that could bring you into contact with the electronics. For this purpose, touch earthed metallic surfaces (e.g. door frames, water pipes or heating valves).

Damage resulting from liquids

This product contains electronic and/or mechanic components that may be damaged by liquids of any kind.

- Keep liquids away from the electronics.

Damage resulting from aggressive cleaning agents

The surface of this product may be damaged as a result of the use of unsuitable cleaning agents.

- Only use cleaning agents that are suitable for plastic or metal surfaces.

Damage as a result of mechanical impact

This product contains electronic components that may be damaged by mechanical impacts of any kind.

1. Avoid touching the electronics.
2. Avoid other mechanical influences on the electronics.

Damage due to polarity reversal

This product contains electronic components that may be damaged by reverse polarity of the power source.

- Do not reverse the polarity of the voltage source (batteries or mains adapters).

Operational malfunction due to radio interference

This product may be affected by electromagnetic or magnetic interference.

- Do not mount or place the product directly next to devices that could cause electromagnetic or magnetic interference (switching power supplies!).

Communication interference due to metallic surfaces

This product communicates wirelessly. Metallic surfaces can greatly reduce the range of the product.

- Do not mount or place the product on or near metallic surfaces.



NOTE

Intended use

SimonsVoss-products are designed exclusively for opening and closing doors and similar objects.

- Do not use SimonsVoss products for any other purposes.

Malfunctions due to poor contact or different discharge

Contact surfaces that are too small/contaminated or different discharged batteries can lead to malfunctions.

1. Only use batteries that are approved by SimonsVoss.
2. Do not touch the contacts of the new batteries with your hands.
3. Use clean and grease-free gloves.
4. Always replace all batteries at the same time.

Different times for G2 locks

The internal time unit of the G2 locks has a technical tolerance of up to ± 15 minutes per year.

Qualifications required

The installation and commissioning requires specialized knowledge.

- Only trained personnel may install and commission the product.

Modifications or further technical developments cannot be excluded and may be implemented without notice.

The German language version is the original instruction manual. Other languages (drafting in the contract language) are translations of the original instructions.

Read and follow all installation, installation, and commissioning instructions. Pass these instructions and any maintenance instructions to the user.

2. Product-specific safety instructions

IMPORTANT

Difficult installation due to threaded sleeves being pressed out

The threaded sleeves in the fitting are installed using a press fit. If you apply excessive pressure when screwing the fitting onto the fixing plate, this can lead to the threaded sleeves slipping out of the fitting.

1. Do not press on the screws when fastening the module support into place.
2. Place a finger on the ends of the threaded sleeves to hold them in place while screwing.

3. Scope of delivery

- SmartHandle AX Advanced for conventional installation 105/145.

- Special tool

- Quick guide

Depending on version:













- Adapter set, 7 mm spindle

- Adapter sleeve, 8.5 mm spindle
- Adapter sleeve, 10 mm spindle





4. Structure



5. Prepare door (drilling template)

- ✓ Pin or scriber at hand.
 - ✓ Drill at hand.
 - ✓ Suitable drill bit at hand (\varnothing 7 mm).
 - ✓ PH2 screwdriver at hand.
1. Insert the spindle into the mortise lock.
 
 2. Place the drilling template on the spindle.
 
 3. Align the drill template vertically using the printed scale.
 4. Mark the drill holes with mark 1.
 
 5. Remove the drilling template and rotate it 180 degrees.
 
 6. Place the drilling template on the spindle.
 
 7. Align the drill template vertically using the printed scale.
 
 8. Mark the drill hole with mark 2.
 
 9. Remove the drilling template and spindle.
 
 10. Remove the mortise lock.
 
 11. Drill the required holes.
 
 12. Fit the mortise lock.
 
 13.
 

6. For door thickness X: have the threaded rods and spindle ready at hand

- ✓ Caliper gauge at hand.
 - ✓ Saw at hand.
 - ✓ PH2 screwdriver at hand.
1. Measure the door thickness.
 
 2. For door thickness X: screw the 50 mm screws, threaded sleeves and threaded rods together.
 
 3. For X: mark the sawing points on the threaded rods and spindle.
 
 17.
 
 4. For X: Use a suitable saw to cut the threaded rods and spindle.
 

7. Installing the fitting

- ✓ Door pre-drilled.
- ✓ PH2 screwdriver at hand.

- ✓ TX15 screwdriver at hand.
 - ✓ Caliper gauge at hand.
1. For non-MO: insert the blank cylinder.



NOTE

Feed the blank cylinder into the hole using a screwdriver

It is difficult to position the blank cylinder correctly, especially in thick doors.

1. Insert a screwdriver into the hole in the blank cylinder.
2. Position the blank cylinder using the screwdriver.



2. For non-MO: screw the blank cylinder firmly into position.



3. Insert the spindle protection tube into the fixing plate.



4. For 7 mm spindle: Insert the adapter shoe into the spindle mount on the module support.



5. Insert the module support into the fastening plate.



6. Slide the module support upwards.



- ↳ Module support snaps into place.

7. Screw the threaded sleeves onto the fixing plate threaded bolts.
8. Fasten the module support to the fastening plate (PH2) with the 12 mm screws.



9. Insert the module support with the fastening plate into the outer side of the door.



NOTE

Reducing sleeves for existing 14 mm holes

Existing 14 mm holes make it difficult to secure the SmartHandle AX Advanced.

- Insert the supplied silicone reducing sleeves into the existing holes to reduce the backlash.

10. For 7 mm spindle: Place the adapter sleeve in the inside handle in such a way that the recess faces the grub screw.



11. Determine the required direction of rotation for your inside handle.

12. Insert the spring element appropriately.



13. Place the underlay in the inner handle unit.



14. Screw the inside handle together with the threaded sleeves and 10 mm screws onto the fixing plate (2.5 mm hex key and PH2).



15. For 8.5 mm and 10 mm spindle: slide the adapter sleeve into the centre of the spindle. Use a punch and hammer to make an indent in the adapter sleeve to prevent it from slipping.





16. Measure the total length of the spindle.



17. Locate the inside of the spindle (four-edge end up) to the centre of the first groove = 26 mm).

18. Use the table to determine the position of the O-ring.



Size	Door thickness (mm)	Spindle length (mm)	Ring position
S	38 – <41	94	2
S	38 – <41	104	4
S	41 – <46	94	1
S	41 – <46	104	3
S	46 – <51	104	2
S	51 – 53	104	1
M	51 – <56	114	3
M	51 – <56	124	5
M	56 – <61	114	2
M	56 – <61	124	4
M	61 – <66	114	1
M	61 – <66	124	3
M	66 – <71	124	2
M	71 – 73	124	1
L	71 – <76	134	3
L	71 – <76	144	5
L	76 – <81	134	2
L	76 – <81	144	4
L	81 – <86	134	1
L	81 – <86	144	3
L	86 – <91	144	2
L	91 – 93	144	1
XL	91 – 176	O-ring is located 30–35 mm from the cut end of the spindle.	

19. Slide the O-ring onto the calculated groove.



20. Insert the spindle into the door with the ring-free side as far as it will go.



21. Measure the door thickness.



Size	Door thickness (mm)	Screws
S	38 – 53	M5×35
M	51 – 63	M5×40
M	62 – 73	M5×50
L	71 – 83	M5×60
L	82 – 93	M5×70
X	91 – 176	M5 X

22. Determine what screws are required for the door thickness measured.

23. For X: Insert the screws through the inner fastening plate and screw them together with the threaded sleeve and threaded rod.



24. Screw the inner part and the outer part (PH2) with the required screws.

**NOTE****Reducing sleeves for existing 14 mm holes**

Existing 14 mm holes make it difficult to secure the SmartHandle AX Advanced.

- Insert the supplied silicone reducing sleeves into the existing holes to reduce the backlash.



43



44



45



46



47



48

25. Fasten the inner handle grub screw firmly (TX15).



49

26. Place a cover with the notch facing downwards onto the escutcheon base.



50

27. Place the cover on top of the fastening plate.



51

28. Fold down the cover.



52

29. Slide the cover upwards.



53

30. Press the inlay into place.



54

31. Fit the outside handle.



55

32. Use the grub screw to fasten the outer handle (TX15) into position.



56

- SmartHandle AX Advanced fully installed.



57

8. Removing the fitting (105/145)

- 1.5 mm hexagonal wrench available.

- Remove the fitting in the reverse order to installation.
- Loosen the cover by bending the inlay outwards using the special tool.
- Insert a 1.5 mm hex key into the hole in the spindle mount in the module support.



58

- Bend the hex key to the side where the hole is located while pulling on the outside handle.



59

- SmartHandle AX Advanced is now removed.

9. Replacing the batteries



















NOTE

Malfunctions due to poor contact or different discharge

Contact surfaces that are too small/contaminated or different discharged batteries can lead to malfunctions.

1. Only use batteries that are approved by SimonsVoss.
2. Do not touch the contacts of the new batteries with your hands.
3. Use clean and grease-free gloves.
4. Always replace all batteries at the same time.

- ✓ Special tool at hand.
- ✓ Gloves at hand.

1. Insert the special tool into the cover inlay on the electronics side.
  60
2. Use the special tool to carefully bend the cover inlay upwards.
  61
3. Slide the cover downwards.
  62
 - ↳ Cover unlocked.
4. Remove the cover.
  63
5. Use the special tool to detach the battery module clip.
  64
6. Remove the battery module.
  65
7. Use the special tool to detach the battery clip.
  66
8. Remove the upper batteries.
  67
9. Carefully bend the intermediate spring to one side.
10. Remove the lower batteries.
  68
11. Insert two new batteries with the positive terminals next to each other (type CR2450).
  69
 - ↳ Intermediate spring visible above the lower batteries.
12. Insert two new batteries with the positive terminals next to each other (type CR2450).
  70
13. Reattach the battery clip.
  71
14. Put the battery module back into the module support.
  72
15. Use the special tool to reattach the battery module clip.
  73
 - ↳ SmartHandle AX Advanced will beep three times.
16. Place the cover on top of the fastening plate.
  74
17. Fold down the cover.
  75
18. Push the cover against the door, sliding it upwards at the same time.
  76
 - ↳ Cover snaps into place.

19. Press the inlay into place.



- ↳ Batteries are now replaced.

10. Technical data

Operating temperature range	-25 °C to +60 °C
Battery type	4x CR2450 3V lithium
Battery manufacturer	<ul style="list-style-type: none"> ■ Murata ■ Panasonic ■ Varta
IP protection rating	Up to IP66 (WP variant)

Radio emissions

15.24 kHz - 72.03 kHz Only for item numbers: SV-S3.*AM.G2*, SV-S3.*A.G2*, SI-S3.*LN*	10 dBµA/m (3 m distance)
13.560006 MHz - 13.560780 MHz Only for item numbers: SV-S3.*AM.G2*, SV-S3.*A.G2*, SI-S3.*M.WO*, SI-S3.*LN*	1.04 dBµA/m (3 m distance)
868.000 MHz - 868.600 MHz / 869.700 MHz - 870.000 MHz Only for item numbers: SI-S3.*M.WO*, SI-S3.*LN*	<25 mW ERP
2402 MHz - 2480 MHz Only for item numbers: SV-S3.*AM.G2*, SV-S3.*A.G2*, SI-S3.*M.WO*, SI-S3.*LN*	2.5 mW

11. Declaration of conformity

The company SimonsVoss Technologies GmbH hereby declares that the articles (SI-S3.*M.VCN*, SV-S3.*M.G2*, SV-S3.*AM.G2*, SV-S3.*A.G2*, SI-S3.*M.WO*, SI-S3.*LN*) comply with the following guidelines:

- 2014/53/EU -RED- or for the UK: UK statutory 2017 No. 1206 -Radio equipment-
- 2011/65/EU -RoHS- or for the UK: UK statutory 2012 No. 3032 -RoHS-



The full text of the EU Declaration of conformity is available at the following internet address: www.simons-voss.com/en/certificates.html.
The full text of the UK Declaration of conformity is available at the following internet address: www.simons-voss.com/en/certificates.html.

12. Help and other information

Information material/documents

<https://www.simons-voss.com/en/documents.html>
<https://www.smartintego.com/int/home/infocenter/documentation>

Declarations of conformity

<https://www.simons-voss.com/en/certificates.html>

Information on disposal

- Do not dispose the device (SI-S3.*M.VCN*, SV-S3.*M.G2*, SV-S3.*AM.G2*, SV-S3.*A.G2*, SI-S3.*M.WO*, SI-S3.*LN*) in the household waste. Dispose of it at a collection point for electronic waste as per European Directive 2012/19/EU.
- Recycle defective or used batteries in line with European Directive 2006/66/EC.
- Observe local regulations on separate disposal of batteries.
- Take the packaging to an environmentally responsible recycling point.



Technical support

+49 (0) 89 / 99 228 333

Email

support-simonsvoss@allegion.com

si-support-simonsvoss@allegion.com

FAQs

<https://faq.simons-voss.com/otrs/public.pl>

SimonsVoss Technologies GmbH, Feringastr. 4, D-85774 Unterfoehring,
Germany

1. Consignes de sécurité générales

Mot indicateur: Effets immédiats possibles du non-respect

AVERTISSEMENT: Mort ou blessure grave (possible, mais improbable), PRUDENCE: Blessure légère, ATTENTION: Dommages matériels ou dysfonctionnements, NOTE: Peu ou pas



AVERTISSEMENT

Accès bloqué

Toute erreur de montage et/ou de programmation d'un composant peut bloquer l'accès par une porte. La société SimonsVoss Technologies GmbH décline toute responsabilité quant aux conséquences d'un accès bloqué, par exemple, accès pour les personnes blessées ou en danger, dommages matériels ou autres dommages !

Accès bloqué par la manipulation du produit

Si vous modifiez vous-même le produit, des dysfonctionnements peuvent se produire et l'accès peut être bloqué par une porte.

- Ne changer le produit que lorsque cela est nécessaire et de la manière décrite dans la documentation.

Ne pas saisir la pile. Risque de brûlures dues à des substances dangereuses

Ce produit contient des piles au lithium. En cas d'ingestion de la pile, de graves brûlures internes peuvent se produire sous deux heures et entraîner la mort.

1. Conservez les piles neuves et usagées hors de portée des enfants.
2. Si le compartiment à piles ne ferme pas correctement, cessez d'utiliser le produit et conservez-le hors de portée des enfants.
3. En cas de suspicion d'ingestion des piles ou si celles-ci se trouvent dans une partie quelconque de votre corps, consultez immédiatement un médecin.

Risque d'explosion dû à un type de batterie incorrect

L'insertion d'un mauvais type de batterie peut provoquer une explosion.

- Utilisez uniquement les piles indiquées dans les données techniques.



PRUDENCE

Risque d'incendie dû aux piles

En cas de manipulation impropre, les piles insérées peuvent provoquer un incendie ou des brûlures.

1. Ne jamais essayer de recharger les piles, de les ouvrir, de les chauffer ou de les brûler.
2. Ne pas court-circuiter les piles.

ATTENTION

Endommagement lié à une décharge électrostatique (DES) lorsque le boîtier est ouvert

Ce produit contient des composants électroniques susceptibles d'être endommagés par des décharges électrostatiques.

1. Utilisez du matériel de travail adapté à la DES (par ex. un bracelet de mise à la terre).
2. Reliez-vous à la terre avant de commencer les travaux pendant lesquels vous pouvez être en contact avec le système électronique. Saisissez pour cela des surfaces métalliques mises à la terre (par ex. huisseries de porte, conduites d'eau ou vannes de chauffage).

Endommagement lié à des liquides

Ce produit contient des composants électroniques et/ou mécaniques susceptibles d'être endommagés par tout type de liquide.

- Tenez les liquides à l'écart du système électronique.

Endommagement lié à des nettoyeurs agressifs

La surface de ce produit peut être endommagée par des nettoyeurs inappropriés.

- Utilisez exclusivement des nettoyeurs adaptés aux surfaces plastiques ou métalliques.

Endommagement lié à une action mécanique

Ce produit contient des composants électroniques susceptibles d'être endommagés par une action mécanique quelconque.

1. Évitez de toucher le système électronique.
2. Évitez toute autre action mécanique sur le système électronique.

Endommagement lié à une inversion de polarité

Ce produit contient des composants électroniques susceptibles d'être endommagés par une inversion de polarité de la source de tension.

- N'inversez pas la polarité de la source de tension (piles ou blocs d'alimentation).

Défaillance du fonctionnement liée à une perturbation radioélectrique

Dans certaines circonstances, ce produit peut subir l'influence de perturbations électromagnétiques ou magnétiques.

- Ne montez pas et ne placez pas le produit à proximité immédiate d'appareils pouvant générer des perturbations électromagnétiques ou magnétiques (alimentations à découpage !).

Défaillance de la communication liée à des surfaces métalliques

Ce produit communique sans fil. Les surfaces métalliques peuvent réduire considérablement le rayon d'action du produit.

- Ne montez pas et ne placez pas le produit sur ou à proximité de surfaces métalliques.



NOTE

Utilisation conforme aux dispositions

Les produits SimonsVoss sont exclusivement destinés à l'ouverture et la fermeture de portes et d'objets similaires.

- N'utilisez pas les produits SimonsVoss à d'autres fins.

Horaires différents pour les fermetures G2

L'unité de temps interne des fermetures G2 présente une tolérance technique pouvant atteindre ± 15 minutes par an.

Qualifications requises

L'installation et la mise en service nécessitent des connaissances spécialisées.

- Seul le personnel qualifié peut installer et mettre en service le produit.

Dysfonctionnements dus à un mauvais contact ou à une décharge différentielle

Des surfaces de contact trop petites/contaminées ou différentes batteries déchargées peuvent entraîner des dysfonctionnements.

1. Utilisez uniquement des piles autorisées par la société SimonsVoss.
2. Ne touchez pas les contacts des piles neuves avec les mains.
3. Utilisez des gants propres et exempts de graisse.
4. Remplacez toujours toutes les piles à la fois.

Les modifications et nouveaux développements techniques ne peuvent pas être exclus et peuvent être mis en œuvre sans préavis.

La version allemande est le manuel d'instruction original. Les autres langues (réduction dans la langue du contrat) sont des traductions des instructions originales.

Lisez et suivez toutes les instructions d'installation, d'installation et de mise en service. Transmettez ces instructions et toutes les instructions de maintenance à l'utilisateur.

2. Consignes de sécurité propres au produit

ATTENTION

Montage difficile en raison de douilles filetées expulsées

Les douilles filetées dans la garniture sont montées avec un ajustement serré. Une pression excessive lors du vissage de la garniture sur la plaque de fixation peut entraîner le glissement des douilles filetées hors de la garniture.

1. N'appuyez pas sur les vis lors du vissage du support de module.
2. Utilisez un doigt aux extrémités des douilles filetées pour exercer une résistance pendant le serrage.

3. Fourniture

SmartHandle AX Advanced pour le montage conventionnel 105/145.

Outil spécial

Guide abrégé

Selon la version :

- Kit d'adaptateur Carré de 7 mm
- Manchon adaptateur Carré de 8,5 mm
- Manchon adaptateur Carré de 10 mm

4. Structure



5. Préparer la porte (gabarit de perçage)

- Goupille ou pointe disponible.
- Perceuse disponible.
- Foret adapté disponible (Ø 7 mm).
- Tournevis PH2 disponible.

1. Insérez le carré dans la serrure encastrée.



2. Placez le gabarit de perçage sur le carré.



3. Orientez le gabarit de perçage à la verticale au moyen de la graduation imprimée.

4. Marquez les trous de perçage avec le repère 1.



5. Retirez le gabarit de perçage et tournez-le de 180 degrés.



6. Placez le gabarit de perçage sur le carré.



7. Orientez le gabarit de perçage à la verticale au moyen de la graduation imprimée.

8. Marquez le trou de perçage avec le repère 2.



9. Retirez le gabarit de perçage et le carré.



10. Démontez la serrure encastrée.



11. Percez les trous nécessaires.



12. Montez la serrure encastrée.



6. Pour épaisseur de porte X : préparer les tiges filetées et le carré

- Pied à coulisse disponible.
- Scie disponible.
- Tournevis PH2 disponible.

1. Mesurez l'épaisseur de porte.



2. Pour une épaisseur de porte X : Assemblez les vis de 50 mm, les manchons filetés et les tiges filetées.



3. Pour X : Repérez les points de sciage sur les tiges filetées et sur le carré.



4. Pour X : Au moyen d'une scie adaptée, raccourcissez les tiges filetées et le carré.



7. Monter la garniture

- Porte prépercée.
- Tournevis PH2 disponible.
- Tournevis TX15 disponible.
- Pied à coulisse disponible.

1. En l'absence de surverrouillage mécanique : Insérez le cylindre aveugle.



NOTE

Guider le cylindre aveugle dans le trou avec un tournevis

Il est particulièrement difficile de positionner correctement le cylindre aveugle lorsque les portes sont épaisses.

1. Insérez un tournevis dans le trou du cylindre aveugle.
2. Positionnez le cylindre aveugle au moyen du tournevis.



2. En l'absence de surverrouillage mécanique : Vissez le cylindre aveugle.



3. Insérez le tube de protection carré dans la plaque de fixation.



4. Pour un carré de 7 mm : Placez le dispositif d'adaptation dans le logement carré du support de module.



5. Insérez le support de module dans la plaque de fixation.



6. Poussez le support de module vers le haut.



Le support de module s'enclenche.

7. Vissez les douilles filetées sur les boulons filetés de la plaque de fixation.

8. Vissez le support de module sur la plaque de fixation au moyen des vis de 12 mm (PH2).



9. Insérez le support de module avec la plaque de fixation, côté extérieur de la porte.

**NOTE****Douilles de réduction pour les trous de 14 mm existants**

Les trous de 14 mm existants complètent la fixation sûre du SmartHandle AX Advanced.

- Insérez les douilles de réduction en silicone fournies dans les trous existants pour réduire le jeu.

10. Pour un carré de 7 mm : Placez le manchon adaptateur dans la poignée intérieure de manière à ce que l'évidement soit dirigé vers la vis sans tête.



28

11. Déterminez le sens de rotation souhaité pour votre poignée intérieure.
12. Insérez l'élément de ressort en conséquence.



29



30

13. Placez le support dans l'unité de béquille intérieure.



31

14. Vissez la béquille intérieure sur la plaque de fixation avec les douilles filetées et les vis de 10 mm (clé hexagonale de 2,5 mm et PH2).



32



33

15. Pour un carré de 8,5 ou de 10 mm : Poussez le manchon adaptateur au milieu du carré. Réalisez un renforcement dans le manchon adaptateur au moyen d'un poinçon et d'un marteau afin d'éviter qu'il ne glisse.



34



35

16. Mesurez la longueur totale du carré.



36

17. Déterminez le côté intérieur du carré (de la fin du carré au milieu de la rainure = 26 mm).

18. Déterminez la position du joint torique sur la base du tableau.



37

Zone	Épaisseur de porte (mm)	Longueur du carré (mm)	Position de la bague
S	38 - <41	94	2
S	38 - <41	104	4
S	41 - <46	94	1
S	41 - <46	104	3
S	46 - <51	104	2
S	51 - 53	104	1
M	51 - <56	114	3
M	51 - <56	124	5
M	56 - <61	114	2
M	56 - <61	124	4
M	61 - <66	114	1
M	61 - <66	124	3
M	66 - <71	124	2
M	71 - 73	124	1
L	71 - <76	134	3
L	71 - <76	144	5
L	76 - <81	134	2
L	76 - <81	144	4
L	81 - <86	134	1
L	81 - <86	144	3
L	86 - <91	144	2
L	91 - 93	144	1
XL	91 - 176	Le joint torique se situe à 30-35 mm de l'extrémité sciée du carré.	

19. Poussez le joint torique sur la rainure calculée.



38

20. Insérez à fond le carré dans la porte par le côté sans bague.



39

21. Mesurez l'épaisseur de porte.



40

Zone	Épaisseur de porte (mm)	Fixation par vis
S	38 - 53	M5×35
M	51 - 63	M5×40
M	62 - 73	M5×50
L	71 - 83	M5×60
L	82 - 93	M5×70
X	91 - 176	M5 X

22. Déterminez les vis nécessaires sur la base de l'épaisseur de porte mesurée.

23. Pour X : insérez les vis à travers la plaque de fixation côté intérieur et vissez-les avec le manchon fileté et la tige fileté.



41



42

24. Vissez la partie intérieure et la partie extérieure (PH2) à l'aide des vis déterminées.



NOTE

Douilles de réduction pour les trous de 14 mm existants

Les trous de 14 mm existants compliquent la fixation sûre du SmartHandle AX Advanced.

- Insérez les douilles de réduction en silicone fournies dans les trous existants pour réduire le jeu.



43



44



45



46



47



48

25. Vissez la vis sans tête de la béquille intérieure (TX15).



49

26. Emboîtez un cache avec l'encoche vers le bas sur la base de la béquille intérieure.



50

27. Placez le capot en haut de la plaque de fixation.



51

28. Rabattez le capot vers le bas.



52

29. Poussez le capot vers le haut.



53

30. Appuyez fermement sur l'incrustation.



54

31. Mettez en place la poignée extérieure.



55

32. Vissez la béquille extérieure à l'aide de la vis sans tête (TX15).



56

- ↳ Le montage de la SmartHandle AX Advanced est terminé.



57

8. Démonter la garniture (105/145)

- ✓ Clé à six pans 1,5 mm disponible.

1. Démontez la serrure en procédant comme pour le montage mais dans l'ordre inverse.

2. Pour ce faire, désolidarisez le capot en pliant l'incrustation vers l'extérieur au moyen de l'outil spécial.

3. Insérez une clé à six pans 1,5 mm dans le trou du logement du carré dans le support de module.



58

4. Pliez la clé à six pans du côté où se trouve le trou tout en tirant sur la poignée extérieure.



59

- ↳ La SmartHandle AX Advanced est démontée.

9. Remplacer les piles

NOTE

Dysfonctionnements dus à un mauvais contact ou à une décharge différente

Des surfaces de contact trop petites/contaminées ou différentes batteries déchargées peuvent entraîner des dysfonctionnements.

1. Utilisez uniquement des piles autorisées par la société SimonsVoss.
2. Ne touchez pas les contacts des piles neuves avec les mains.
3. Utilisez des gants propres et exempts de graisse.
4. Remplacez toujours toutes les piles à la fois.

- ✓ Outil spécial disponible.

- ✓ Gants disponible.

1. Insérez l'outil spécial dans l'incrustation du capot du côté électronique.



60

2. Au moyen de l'outil spécial, pliez avec précaution l'incrustation du capot.



61

3. Poussez le capot vers le bas.



62

- ↳ Le capot se déverrouille.

4. Retirez le capot.



63

5. Au moyen de l'outil spécial, décrochez les clips du module de batterie.



64

6. Retirez le module de piles.



65

7. Au moyen de l'outil spécial, décrochez les clips des piles.



66

8. Retirez les piles du haut.



67

9. Pliez avec précaution le ressort intermédiaire sur le côté.

10. Retirez les piles du bas.



68

11. Insérez deux nouvelles piles avec les pôles plus au contact l'un de l'autre (type CR2450).



69

- ↳ Ressort intermédiaire visible au-dessus des piles du bas.

12. Insérez deux nouvelles piles avec les pôles plus au contact l'un de l'autre (type CR2450).



70

13. Refermez les clips des piles.



71

14. Réinsérez le module de piles dans le support de module.



72

15. Au moyen de l'outil spécial, refermez les clips du module de batterie.



73

- ↳ La SmartHandle AX Advanced émet trois bips.

16. Placez le capot en haut de la plaque de fixation.



74

17. Rabattez le capot vers le bas.



75

18. Appuyez le capot contre la porte tout en le faisant glisser vers le haut.



76

- ↳ Le capot s'enclenche.

19. Appuyez fermement sur l'incrustation.



- ↳ Les piles sont changées.

10. Caractéristiques techniques

Plage de températures (fonctionnement)	de -25 °C à +60 °C
Type de piles	4× piles CR2450 3V Lithium
Fabricant des piles	<ul style="list-style-type: none"> ■ Murata ■ Panasonic ■ Varta
Classe de protection IP	Jusqu'à IP66 (version WP)

Émissions de radio

15,24 kHz - 72,03 kHz Seulement pour les numéros d'article : SV-S3.*AM.G2*, SV-S3.*A.G2*, SI-S3.*LN*	10 dBµA/m (3 m distance)
13,560006 MHz - 13,560780 MHz Seulement pour les numéros d'article : SV-S3.*AM.G2*, SV-S3.*A.G2*, SI-S3.*M.WO*, SI-S3.*LN*	1,04 dBµA/m (3 m distance)
868,000 MHz - 868,600 MHz / 869,700 MHz - 870,000 MHz Seulement pour les numéros d'article : SI-S3.*M.WO*, SI-S3.*LN*	<25 mW ERP
2402 MHz - 2480 MHz Seulement pour les numéros d'article : SV-S3.*AM.G2*, SV-S3.*A.G2*, SI-S3.*M.WO*, SI-S3.*LN*	2,5 mW

11. Déclaration de conformité

La société SimonsVoss Technologies GmbH déclare par la présente que les articles (SI-S3.*M.VCN*, SV-S3.*M.G2*, SV-S3.*AM.G2*, SV-S3.*A.G2*, SI-S3.*M.WO*, SI-S3.*LN*) est conforme aux directives suivantes:

- 2014/53/EU -RED-
ou pour UK : UK statutory 2017 No. 1206 -Radio equipment-
(équipement radio)
- 2011/65/UE -RoHS-
ou pour UK : UK statutory 2012 No. 3032 -RoHS-



Le texte intégral de la déclaration de conformité CE est disponible à l'adresse Internet suivante : www.simons-voss.com/fr/certificats.html.
Le texte intégral de la déclaration de conformité UK est disponible à l'adresse Internet suivante : www.simons-voss.com/fr/certificats.html.

12. Aide et autres informations

Documentation/documents

<https://www.simons-voss.com/fr/documents.html>
<https://www.smartintego.com/fr/home/infocenter/documentations>

Déclarations de conformité

<https://www.simons-voss.com/fr/certificats.html>

Informations sur l'élimination

- Ne jetez pas l'appareil (SI-S3.*M.VCN*, SV-S3.*M.G2*, SV-S3.*AM.G2*, SV-S3.*A.G2*, SI-S3.*M.WO*, SI-S3.*LN*) avec vos ordures ménagères mais dans un point de collecte communal pour appareils électriques et appareils spéciaux conformément à la directive européenne 2012/19/UE.
- Recyclez les piles défectueuses ou usées conformément à la directive européenne 2006/66/CE.

- Veuillez tenir compte des dispositions locales applicables concernant la collecte séparée des piles.

- Recyclez l'emballage d'une manière écologique.



Assistance technique

+49 (0) 89 / 99 228 333

E-Mail

support-simonsvoss@allegion.com
si-support-simonsvoss@allegion.com

FAQ

<https://faq.simons-voss.com/otrs/public.pl>
SimonsVoss Technologies GmbH, Feringastr. 4, D-85774 Unterföhring, Allemagne

1. Algemene veiligheidsinstructies

Signaalwoord: *Mogelijke onmiddellijke gevolgen van niet-naleving*
WAARSCHUWING: Dood of ernstig letsel (mogelijk, maar onwaarschijnlijk).
VOORZICHTIG: Lichte letsel, LET OP: Materiele schade of storing, OPMERKING: Laag of nee



WAARSCHUWING

Geblokkeerde toegang

Door foutief geïnstalleerde en/of geprogrammeerde componenten kan de doorgang door een deur geblokkeerd blijven. Voor gevolgen van een geblokkeerde toegang tot gewonden of personen in gevaar, materiële of andere schade, is SimonsVoss Technologies GmbH niet aansprakelijk.

Geblokkeerde toegang als gevolg van manipulatie van het product

Als u het product zelf wijzigt, kunnen er storingen optreden en kan de toegang worden geblokkeerd door een deur.

- ▀ Vervang het product alleen wanneer dat nodig is en op de manier die in de documentatie wordt beschreven.

Batterijen niet inslikken. Verbrandingsgevaar door gevaarlijke stoffen

Dit product bevat lithium-knoopcellen. Als de knoopcel wordt ingeslikt, kunnen ernstige inwendige brandwonden optreden die binnen slechts twee uur de dood veroorzaken.

1. Houd nieuwe en gebruikte batterijen buiten bereik van kinderen.
2. Als het batterijvak niet goed sluit, mag u het product niet meer gebruiken en moet u het uit de buurt van kinderen houden.
3. Als u denkt dat batterijen zijn ingeslikt of in een ander lichaamsdeel terecht zijn gekomen, moet u onmiddellijk medische hulp inroepen.

Explosiegevaar door verkeerd type batterij

Het plaatsen van het verkeerde type batterij kan een explosie veroorzaken.

- ▀ Gebruik alleen de in de technische gegevens vermelde batterijen.



VOORZICHTIG

Brandgevaar door batterijen

De gebruikte batterijen kunnen bij verkeerde behandeling tot brand- of verbrandingsgevaar leiden.

1. Probeer niet de batterijen op te laden, open te maken, te verwarmen of te verbranden.
2. U mag de batterijen evenmin kortsluiten.

LET OP

Schade door elektrostatische ontlading (ESD) wanneer de behuizing open is

Dit product heeft elektronische componenten die kunnen worden beschadigd door een elektrostatische ontlading.

1. Maak gebruik van ESD-conforme materialen (bijv. aardingsarmband).
2. Zorg dat u geaard bent voor werkzaamheden waarbij u met de elektronica in contact kunt komen. Gebruik hiervoor geaarde metalen oppervlakken (bijv. Deurposten, waterleidingen of verwarmingsbuizen).

Beschadiging door vloeistoffen

Dit product heeft elektronische en/of mechanische componenten die kunnen worden beschadigd door elk type vloeistof.

- ▀ Houd vloeistoffen uit de buurt van de elektronica.

Beschadiging door bijtende reinigingsmiddelen

Het oppervlak van dit product kan worden beschadigd door ongeschikte reinigingsmiddelen.

- ▀ Maak uitsluitend gebruik van reinigingsmiddelen die geschikt zijn voor kunststof of metalen oppervlakken.

Beschadiging door mechanische impact

Dit product heeft elektronische componenten die kunnen worden beschadigd door elk type mechanische impact.

1. Vermijd dat u de elektronica aanraakt.
2. Vermijd ook andere mechanische impact op de elektronica.

Beschadiging door verwisseling van de polariteit

Dit product bevat elektronische componenten die door verwisseling van de polariteit van de voedingsbron beschadigd kunnen worden.

- ▀ Vervissel de polariteit van de voedingsbron niet (batterijen of netadapters).

Storing van het gebruik door verbroken verbinding

Dit product kan onder bepaalde omstandigheden beïnvloed worden door elektromagnetische of magnetische storingen.

- ▀ Monteer of plaats het product niet direct in de buurt van apparaten die elektromagnetische of magnetische storingen kunnen veroorzaken (stroomschakelaars!).

Storing van de communicatie door metalen oppervlakken

Dit product communiceert draadloos. Metalen oppervlakken kunnen het zendbereik van het product aanzienlijk verminderen.

- ▀ Monteer of plaats het product niet op of in de buurt van metalen oppervlakken.



OPMERKING

Beoogd gebruik

SimonsVoss-producten zijn uitsluitend bedoeld voor het openen en sluiten van deuren en vergelijkbare voorwerpen.

- ▀ Gebruik SimonsVoss-producten niet voor andere doeleinden.

Storingen door slecht contact of verschillende ontladingen

Contactoppervlakken die te klein/vervuld zijn of verschillende ontladen accus' kunnen leiden tot storingen.

1. Gebruik alleen batterijen die zijn vrijgegeven door SimonsVoss.
2. Raak de contacten van de nieuwe batterijen niet met de handen aan.
3. Gebruik schone, vetvrije handschoenen.
4. Vervang daarom alle batterijen tegelijk.

Afwijkende tijden bij G2-sluitelementen

De interne tijdeenheden van de G2-sluitelementen heeft een technisch bepaalde tolerantie van max. ± 15 minuten per jaar.

Kwalificaties vereist

De installatie en inbedrijfstelling vereist gespecialiseerde kennis. Alleen getraind personeel mag het product installeren en in bedrijf stellen.

Aanpassingen of nieuwe technische ontwikkelingen kunnen niet uitgesloten worden en worden gerealiseerd zonder aankondiging.

De Duitse taalversie is de originele handleiding. Andere talen (opstellen in de contracttaal) zijn vertalingen van de originele instructies.

Lees en volg alle installatie-, installatie- en inbedrijfstellingsinstructies. Geef deze instructies en eventuele onderhoudsinstructies door aan de gebruiker.

2. Specifieke veiligheidsinstructies per product

LET OP

Moelijke montage door naar buiten gedrukte schroefdraadhuizen

De schroefdraadhuizen in het beslag zijn met een perspassing gemonteerd. Overmatige druk bij het vastschroeven van het beslag op de bevestigingsplaat kan ertoe leiden dat de schroefdraadhuizen uit het beslag glijden.

1. Druk bij het vastschroeven van de moduledrager niet op de schroeven.
2. Houd de uiteinden van de schroefdraadhuizen met een vinger tegen tijdens het vastschroeven.

3. Leveromvang

- SmartHandle AX Advanced voor de conventionele montage 105/145.
 - Speciaal gereedschap
 - Korte handleiding
- Afhankelijk van de variant:
- adapterset 7 mm vierkant
 - adapterhuls 8,5 mm vierkant
 - adapterhuls 10 mm vierkant

4. Opbouw



5. Deur voorbereiden (boormal)

- ✓ Pen of kraspen beschikbaar.
- ✓ een boormachine beschikbaar houden.
- ✓ Geschikte boor beschikbaar (Ø 7 mm).
- ✓ PH2-schroevendraaier beschikbaar.

1. Steek het vierkant in het insteekslot.



2. Plaats de boormal op het vierkant.



3. Lijn de boormal verticaal uit met behulp van de opgedrukte schaalverdeling.

4. Markeer de boorgaten met markering 1.



5. Verwijder de boormal en draai deze 180 graden.



6. Plaats de boormal op het vierkant.



7. Lijn de boormal verticaal uit met behulp van de opgedrukte schaalverdeling.

8. Markeer het boorgat met de markering 2.



9. Neem de boormal en het vierkant weg.



10. Demonteer het insteekslot.



11. Boor de benodigde gaten.



12. Bouw het insteekslot in.



6. Voor deurdikte X: draadstangen en vierkant voorbereiden

- ✓ Remklauwmeter beschikbaar.
- ✓ Saw beschikbaar.
- ✓ PH2-schroevendraaier beschikbaar.

1. Meet de deurdikte.



2. Voor deurdikte X: schroef de schroeven van 50 mm, de draadbussen aan elkaar.



3. Voor X: markeer de punten waar gezaagd moet worden op de draadstangen en op het vierkant.



4. Voor X: kort de draadstangen en het vierkant af met een geschikte zaag.



7. Beslag monteren

- ✓ Deur voorgeboord.
- ✓ PH2-schroevendraaier beschikbaar.
- ✓ TX15-schroevendraaier beschikbaar.
- ✓ Remklauwmeter beschikbaar.

1. Voor niet-MO: breng de blinde cilinder aan.



OPMERKING

Blinde cilinder met schroevendraaier in het gat leiden

In het bijzonder bij dikke deuren is het moeilijk om de blinde cilinder correct te positioneren.

1. Steek een schroevendraaier in het gat van de blinde cilinder.
2. Positioneer de blinde cilinder met behulp van de schroevendraaier.



2. Voor niet-MO: schroef de blinde cilinder vast.



3. Plaats het beschermhuisje voor de vierkantstift in de bevestigingsplaat.



4. Voor 7 mm vierkant: zet de adapterschoen in de vierkante uitsparing van de moduledrager.



5. Steek de moduledrager in de bevestigingsplaat.



6. Schuif de moduledrager omhoog.



- ↳ De moduledrager klikt vast.

7. Schroef de schroefdraadhulzen op de schroefdraadbouten van de bevestigingsplaat.



8. Schroef de moduledrager met de schroeven van 12 mm vast op de bevestigingsplaat (PH2).



9. Steek de moduledrager met de bevestigingsplaat in de buitenkant van de deur.



OPMERKING

Verloopbussen voor bestaande 14 mm-boringen

Reeds aanwezige boringen van 14 mm bemoeilijken de veilige aanbrenging van de SmartHandle AX Advanced.

- Steek de meegeleverde siliconen verloopbussen in de aanwezige boringen om de speling te verkleinen.

10. Voor 7 mm vierkant: breng de adapterhuls zodanig aan in de binnendeurkruk dat de uitsparing naar de stiftap wijst.



11. Bepaal de gewenste draairichting van uw binnendeurkruk.

12. Breng het veerelement dienovereenkomstig aan.





13. Plaats de basis in de eenheid van de binnendeurkruk.



14. Schroef de binnendeurkruk samen met de schroefdraadhulzen en de 10 mm schroeven op de bevestigingsplaat (2,5 mm inbussleutel en PH2).



15. Voor 8,5 mm en 10 mm vierkant; schuif de adapterhuls in het midden van het vierkant. Maak met een centerpons en een hamer een verdiept punt in de adapterhuls om verschuiven te voorkomen.



16. Meet de totale lengte van de vierkantstift.



17. Bepaal de binnenkant van de vierkantstift (uiteinde tot het midden van de eerste groef = 26 mm).

18. Bepaal de positie van de O-ring met behulp van de tabel.



Bereik	Deurdikte (mm)	Lengte vierkantstift (mm)	Ringpositie
S	38 - <41	94	2
S	38 - <41	104	4
S	41 - <46	94	1
S	41 - <46	104	3
S	46 - <51	104	2
S	51 - 53	104	1
M	51 - <56	114	3
M	51 - <56	124	5
M	56 - <61	114	2
M	56 - <61	124	4
M	61 - <66	114	1
M	61 - <66	124	3
M	66 - <71	124	2
M	71 - 73	124	1
L	71 - <76	134	3
L	71 - <76	144	5
L	76 - <81	134	2
L	76 - <81	144	4
L	81 - <86	134	1
L	81 - <86	144	3
L	86 - <91	144	2
L	91 - 93	144	1
XL	91 - 176	De O-ring ligt op 30-35 mm van het afgezaagde uiteinde van de vierkantstift.	

19. Schuif de O-ring op de berekende groef.



20. Steek het vierkant met de kant zonder ring tot de aanslag in de deur.



21. Meet de deurdikte.



Bereik	Deurdikte (mm)	Schroeven
S	38 - 53	M5×35
M	51 - 63	M5×40
M	62 - 73	M5×50
L	71 - 83	M5×60
L	82 - 93	M5×70
X	91 - 176	M5 X

22. Bepaal aan de hand van de gemeten deurdikte welke schroeven er nodig zijn.

23. Voor X: Steek de schroeven door de bevestigingsplaat aan de binnenkant en schroef ze met hun draadbus en draadstang in elkaar.



24. Schroef het binnengedeelte en het buitengedeelte (PH2) vast met de vastgestelde schroeven.

**OPMERKING****Verloopbussen voor bestaande 14 mm-boringen**

Reeds aanwezige boringen van 14 mm bemoeilijken de veilige aanbrenging van de SmartHandle AX Advanced.

- Steek de meegeleverde siliconen verloopbussen in de aanwezige boringen om de speling te verkleinen.



25. Schroef de binnendeurkruk vast met de stifttap (TX15).



26. Steek een afdekking met de inkeping naar beneden op de basis van de binnendeurkruk.



27. zet de cover bovenop de bevestigingsplaat.



28. Klap de cover naar beneden dicht.



29. Schuif de cover omhoog.



30. Druk de inlay vast.



31. Steek de buitendeurkruk erop.



32. Schroef de buitendeurkruk vast met de stifttap (TX15).





- SmartHandle AX Advanced montage afgerond.

**8. Beslag demonteren (105/145)**

- 1,5 mm inbussleutel beschikbaar.

- Demonteer het beslag in omgekeerde volgorde van de montage.

- Maak daarbij de cover los door met het speciale gereedschap de inlay naar buiten te buigen.
- Steek een inbussleutel van 1,5 mm in het gat van de opname voor de vierkantstift in de moduledrager.
  58
- Buig de inbussleutel naar de zijde waar het gat zich bevindt en trek tegelijkertijd aan de buitendeurkruk.
  59

↳ SmartHandle AX Advanced is gemonteerd.

9. Batterijen vervangen















OPMERKING

Storingen door slecht contact of verschillende ontladingen





Contactoppervlakken die te klein/vervuld zijn of verschillende ontladen accu's kunnen leiden tot storingen.

- Gebruik alleen batterijen die zijn vrijgegeven door SimonsVoss.
- Raak de contacten van de nieuwe batterijen niet met de handen aan.
- Gebruik schone, vetvrije handschoenen.
- Vervang daarom alle batterijen tegelijk.

- ✓ Speciaal gereedschap beschikbaar.
- ✓ Handschoenen beschikbaar.

- Steek het speciale gereedschap in de cover-inlay aan de elektronicazijde.
  60
- Buig de coverinlay behoedzaam open met het speciale gereedschap.
  61
- Schuif de cover naar beneden.
  62
 - ↳ Cover ontgrendeld.
- Neem de cover weg.
  63
- Haak met het speciale gereedschap de klem van de batterijmodule los.
  64
- Neem de batterijmodule weg.
  65
- Maak de batterijklem los met het speciale gereedschap.
  66
- Neem de bovenste batterijen uit.
  67
- Buig de tussenveer behoedzaam opzij.
  68
- Neem nu de onderste batterijen uit.
  69
 - ↳ De tussenveer is zichtbaar boven de onderste batterijen.
- Zet twee nieuwe batterijen in met de pluspolen tegen elkaar (type CR2450).
  70
- Haak de batterijklem weer vast.
  71
- Breng de batterijmodule weer aan in de moduledrager.
  72

- Haak met het speciale gereedschap de klem van de batterijmodule weer vast.
  73
 - ↳ SmartHandle AX Advanced piept drie keer.

- zet de cover bovenop de bevestigingsplaat.
  74
- Klap de cover naar beneden dicht.
  75
- Duw de cover tegen de deur en schuif hem tegelijkertijd omhoog.
  76
 - ↳ De cover klikt vast.
- Druk de inlay vast.
  77
 - ↳ De batterijen zijn vervangen.

10. Technische gegevens

Temperatuurbereik (bedrijf)	-25°C tot +60°C
Soort batterij	4x CR2450 3V lithium
Batterijmerk	<ul style="list-style-type: none"> ■ Murata ■ Panasonic ■ Varta
IP-beschermingsklasse	Tot IP66 (WP-variant)

Radio-emissies

15,24 kHz - 72,03 kHz Alleen voor artikelnummers: SV-S3.*AM.G2*, SV-S3.*A.G2*, SI-S3.*LN*	10 dBuA/m (3 m afstand)
13,560006 MHz - 13,560780 MHz Alleen voor artikelnummers: SV-S3.*AM.G2*, SV-S3.*A.G2*, SI-S3.*M.WO*, SI-S3.*LN*	1,04 dBuA/m (3 m afstand)
868,000 MHz - 868,600 MHz / 869,700 MHz - 870,000 MHz Alleen voor artikelnummers: SI-S3.*M.WO*, SI-S3.*LN*	<25 mW ERP
2402 MHz - 2480 MHz Alleen voor artikelnummers: SV-S3.*AM.G2*, SV-S3.*A.G2*, SI-S3.*M.WO*, SI-S3.*LN*	2,5 mW

11. Verklaring van overeenstemming

Het bedrijf SimonsVoss Technologies GmbH verklaart dat de artikelen (SI-S3.*M.VCN*, SV-S3.*M.G2*, SV-S3.*AM.G2*, SV-S3.*A.G2*, SI-S3.*M.WO*, SI-S3.*LN*) voldoen aan de volgende richtlijnen:

- 2014/53/EU - RED- of voor de UK: UK wettelijk 2017 Nr. 1206 -Radioapparatuur-
- 2011/65/EU -RoHS- of voor de UK: UK wettelijk 2012 Nr. 3032 -RoHS-



De volledige tekst van de EU-conformiteitsverklaring is beschikbaar op het volgende internetadres: www.simons-voss.com/nl/certificaten.html. De volledige tekst van de UK-conformiteitsverklaring is beschikbaar op het volgende internetadres: www.simons-voss.com/nl/certificaten.html.

12. Hulp en verdere informatie

Informatiemateriaal/documenten

<https://www.simons-voss.com/nl/documenten.html>

<https://www.smartintego.com/int/home/infocenter/documentation>

Conformiteitsverklaringen

<https://www.simons-voss.com/nl/certificaten.html>

Informatie over verwijdering

- ❑ Voer het apparaat (SI-S3.*M.VCN*, SV-S3.*M.G2*, SV-S3.*AM.G2*, SV-S3.*A.G2*, SI-S3.*M.WO*, SI-S3.*LN*) niet af als huishoudelijk afval, maar overeenkomstig de Europese Richtlijn 2012/19/EU bij een gemeentelijke inzamelpunt voor speciaal elektrotechnisch afval.
- ❑ Zorg voor recycling van defecte of gebruikte batterijen volgens de Europese Richtlijn 2006/66/EG.
- ❑ Neem de plaatselijke bepalingen in acht voor de gescheiden afvoer van batterijen.
- ❑ Voer de verpakking af naar een instantie voor milieuvriendelijke recycling.



78

Technische Support

+49 (0) 89 / 99 228 333

E-mail

support-simonsvoss@allegion.com

si-support-simonsvoss@allegion.com

FAQ

<https://faq.simons-voss.com/otrs/public.pl>

SimonsVoss Technologies GmbH, Feringastr. 4, 85774 Unterföhring, Duitsland

1. Avvisi di sicurezza generali

Parola segnale: Possibili effetti immediati di non conformità

AVVERTENZA: Morte o lesioni gravi (possibili, ma improbabili), ATTENZIONE: Lesione minori, AVVISO: Danni materiali o malfunzionamento, NOTA: Basso o no



AVVERTENZA

Accesso bloccato

Con componenti montati e/o programmati in modo difettoso, l'accesso attraverso una porta può restare bloccato. La SimonsVoss Technologies GmbH non risponde delle conseguenze di un accesso bloccato, per esempio nel caso si debba accedere a persone ferite o in pericolo, di danni a cose o altri danni!

Accesso bloccato tramite manipolazione del prodotto

Se si modifica il prodotto da solo, possono verificarsi malfunzionamenti e l'accesso attraverso una porta può essere bloccato.

- Modificare il prodotto solo quando necessario e solo nel modo descritto nella documentazione.

Non ingerire la batteria. Pericolo di ustioni dovute a sostanze pericolose

Questo prodotto contiene batterie a bottone al litio. Se la batteria a bottone viene inghiottita, possono verificarsi gravi ustioni interne nel giro di sole due ore che possono causare la morte.

1. Conservare le batterie nuove e usate lontano dalla portata dei bambini.
2. Se il vano batteria non si chiude in modo sicuro, interrompere l'uso del prodotto e tenerlo lontano dalla portata dei bambini.
3. Se pensate che le batterie siano state inghiottite o si trovino in una qualsiasi parte del vostro corpo, rivolgetevi immediatamente a un medico.

Pericolo di esplosione a causa di un tipo di batteria non corretto

L'inserimento del tipo di batteria sbagliato può causare un'esplosione.

- Utilizzare solo le batterie specificate nei dati tecnici.



ATTENZIONE

Pericolo di incendio dovuto alle batterie

Le batterie utilizzate possono costituire un pericolo di incendio o combustione in caso di utilizzo scorretto.

1. Non tentare di caricare, aprire, riscaldare o bruciare le batterie.
2. Non cortocircuitare le batterie.

AVVISO

Danni dovuti a scariche elettrostatiche (ESD) quando l'alloggiamento è aperto

Il presente prodotto contiene componenti elettronici che potrebbero subire danni in conseguenza di scariche elettrostatiche.

1. Utilizzare materiali di lavori conformi ai requisiti ESD (ad es. fascetta antistatica al polso).
2. Effettuare la messa a terra dell'operatore prima di eseguire lavori in cui è possibile entrare in contatto con parti elettroniche. A tale scopo, toccare una superficie metallica opportunamente messa a terra (ad es. telaio porta, tubi dell'acqua o valvole di riscaldamento).

Danni dovuti a fluidi

Il presente prodotto contiene componenti elettronici e/o meccanici che potrebbero subire danni dovuti a liquidi di qualunque tipo.

- Tenere i componenti elettronici lontani da liquidi.

Danni dovuti a detergenti aggressivi

La superficie di questo prodotto può essere danneggiata da detergenti non idonei.

- Utilizzare esclusivamente detergenti adatti a superfici in plastica o metallo.

Danni dovuti a effetti meccanici

Il presente prodotto contiene componenti elettronici che potrebbero subire danni dovuti a effetti meccanici di qualunque tipo.

1. Evitare di toccare le parti elettroniche.
2. Evitare ulteriori effetti meccanici sulle parti elettroniche.

Danni dovuti all'inversione di polarità

Questo prodotto contiene componenti elettronici che possono essere danneggiati dall'inversione di polarità della sorgente di tensione.

- Non invertire la polarità della sorgente di tensione (batterie o alimentatori).

Funzionamento disturbato a causa di interferenze radioelettriche

Questo prodotto potrebbe essere influenzato da disturbi elettromagnetici o magnetici.

- Non montare o posizionare il prodotto direttamente accanto a dispositivi che possono causare interferenze elettromagnetiche o magnetiche (alimentatori switching!).

Interferenze nella comunicazione dovute a superfici metalliche

Questo prodotto comunica in modalità wireless. Le superfici metalliche possono ridurre significativamente la portata del prodotto.

- Non montare o posizionare il prodotto sopra o vicino a superfici metalliche.



NOTA

Uso conforme

I prodotti SimonsVoss sono concepiti esclusivamente per l'apertura e la chiusura di porte e oggetti simili.

- Non utilizzare i prodotti SimonsVoss per altri scopi.

Malfunzionamenti dovuti a contatto insufficiente o a scarichi diversi

Superfici di contatto troppo piccole/contaminate o diverse batterie scariche possono portare a malfunzionamenti.

1. Utilizzare esclusivamente batterie autorizzate da SimonsVoss.
2. Non toccare con le mani i contatti delle nuove batterie.
3. Utilizzare guanti puliti e privi di grasso.
4. Sostituire sempre tutte le batterie contemporaneamente.

Tempi diversi per chiusure G2

L'unità temporale interna delle chiusure G2 è tecnicamente vincolata a una tolleranza fino a ± 15 minuti all'anno.

Qualifiche richieste

L'installazione e la messa in servizio richiedono conoscenze specialistiche.

- Solo personale qualificato può installare e mettere in servizio il prodotto.

Non si escludono modifiche o perfezionamenti tecnici, anche senza preavvisi.

La versione in lingua tedesca è il manuale di istruzioni originale. Altre lingue (redazione nella lingua del contratto) sono traduzioni delle istruzioni originali.

Leggere e seguire tutte le istruzioni di installazione, installazione e messa in servizio. Passare queste istruzioni e tutte le istruzioni di manutenzione all'utente.

2. Avvertenze di sicurezza specifiche del prodotto

AVVISO

Montaggio difficoltoso a causa di manicotti filettati spinti fuori.

I manicotti filettati sono montati a pressione nella maniglia. La pressione eccessiva durante l'avvitatura a stringere della maniglia sulla piastra di fissaggio può provocare la fuoriuscita dei manicotti filettati dalla maniglia.

1. Non esercitare pressione sulle viti durante l'avvitamento del supporto del modulo.
2. Tenere un dito alle estremità dei manicotti filettati, in modo da opporre resistenza durante l'avvitamento.

3. Oggetto di fornitura

■ SmartHandle AX Advanced per il montaggio convenzionale 105/145.

■ Attrezzo speciale

■ Libretto di istruzioni

A seconda della variante:

■ Set di adattatori quadro maniglia di 7 mm

■ Manicotto adattatore quadro maniglia di 8,5 mm











■ Manicotto adattatore quadro maniglia di 10 mm

4. Struttura



5. Preparazione della porta (maschera di foratura)





- ✓ Perno o punta per tracciare a disposizione.
- ✓ Trapano a disposizione.
- ✓ Punta adatta a disposizione (\varnothing 7 mm).
- ✓ Cacciavite PH2 a disposizione.

1. Inserire il quadro maniglia nella serratura a incasso.  2
2. Applicare la maschera di foratura sul quadro maniglia.  3
3. Allineare la maschera di foratura in verticale con l'ausilio della scala graduata.  4
4. Contrassegnare i fori con la marcatura 1.  5
5. Rimuovere la maschera di foratura e ruotarla di 180 gradi.  6
6. Applicare la maschera di foratura sul quadro maniglia.  7
7. Allineare la maschera di foratura in verticale con l'ausilio della scala graduata.  8
8. Contrassegnare i fori con la marcatura 2.  9
9. Rimuovere la maschera di foratura e il quadro maniglia.  10
10. Rimuovere la serratura a incasso.  11
11. Praticare i fori necessari.  12

12. Rimontare la serratura a incasso.  13

6. Per lo spessore della porta X: preparazione delle aste filettate e del quadro maniglia

- ✓ Calibro a corsoio a disposizione.
- ✓ Sega a disposizione.
- ✓ Cacciavite PH2 a disposizione.

1. Misurare lo spessore della porta.  14
2. Per lo spessore della porta X: avvitare le viti da 50 mm, i manicotti filettati e le aste filettate.  15
3. Per X: contrassegnare i punti da segare sulle aste filettate e sul quadro maniglia.  16
4. Per X: accorciare le aste filettate e il quadro maniglia con una sega adatta.  17
5. Per X: accorciare le aste filettate e il quadro maniglia con una sega adatta.  18

7. Montaggio della maniglia

- ✓ Porta già forata.
- ✓ Cacciavite PH2 a disposizione.
- ✓ Cacciavite TX15 a disposizione.
- ✓ Calibro a corsoio a disposizione.

1. Per la versione senza MO: inserire il cilindro cieco.











NOTA

Posizionare il cilindro cieco nel foro utilizzando il cacciavite

Soprattutto per le porte di grande spessore, è difficile posizionare correttamente il cilindro cieco.

1. Inserire un cacciavite nel foro del cilindro cieco.
2. Posizionare il cilindro cieco con l'ausilio del cacciavite.

1.  19
2.  20
3. Per la versione senza MO: avvitare il cilindro cieco.  21
4. Inserire il tubo protettivo per quadro maniglia nella piastra di fissaggio.  22
5. Per il quadro maniglia di 7 mm: posizionare la staffetta di adattamento nell'alloggiamento del quadro maniglia del supporto del modulo  23
6. Inserire il supporto del modulo nella piastra di fissaggio.  24
7.  25
↳ Il supporto del modulo è innestato.
8. Avvitare i manicotti filettati sui bulloni filettati della piastra di fissaggio.  26
9. Avvitare il supporto del modulo alla piastra di fissaggio con le viti da 12 mm (PH2).  27

9. Inserire il supporto del modulo con la piastra di fissaggio nel lato esterno della porta.

**NOTA****Manicotti di riduzione per i fori da 14 mm già presenti**

I fori da 14 mm già presenti rendono difficoltoso il fissaggio sicuro di SmartHandle AX Advanced.

- Applicare i manicotti di riduzione in silicone inclusi nella fornitura nei fori già presenti, per ridurre il gioco.

10. Per il quadro maniglia di 7 mm: posizionare il manicotto adattatore nella maniglia interna in modo tale che sia visibile l'incavo per la vite senza testa.



28

11. Stabilire il senso di rotazione desiderato della maniglia interna.

12. Inserire l'elemento a molla correttamente.



29



30

13. Inserire la piastrina nell'unità della maniglia interna.



31

14. Avvitare la maniglia interna insieme ai manicotti filettati e alle viti da 10 mm sulla piastra di fissaggio (chiave esagonale da 2,5 mm e PH2).



32



33

15. Per il quadro maniglia di 8,5 mm e di 10 mm: spingere il manicotto adattatore al centro del quadro maniglia. Con un martello e un punzone realizzare un incavo nel manicotto adattatore per impedire che si muova.



34



35

16. Misurare la lunghezza complessiva del quadro maniglia.



36

17. Rilevare il lato interno del quadro maniglia (dall'estremità del quadro maniglia al centro della prima scanalatura = 26 mm).

18. Determinare la posizione dell'O-ring con la tabella.



37

Area	Spessore porta (mm)	Lunghezza quadro maniglia (mm)	Posizione anello
S	38 - <41	94	2
S	38 - <41	104	4
S	41 - <46	94	1
S	41 - <46	104	3
S	46 - <51	104	2
S	51 - 53	104	1
M	51 - <56	114	3
M	51 - <56	124	5
M	56 - <61	114	2
M	56 - <61	124	4
M	61 - <66	114	1
M	61 - <66	124	3
M	66 - <71	124	2
M	71 - 73	124	1
L	71 - <76	134	3
L	71 - <76	144	5
L	76 - <81	134	2
L	76 - <81	144	4
L	81 - <86	134	1
L	81 - <86	144	3
L	86 - <91	144	2
L	91 - 93	144	1
XL	91 - 176	L'O-ring si trova a 30-35 mm dall'estremità segata del quadro maniglia.	

19. Far scorrere l'O-ring sulla scanalatura calcolata.



38

20. Inserire il lato senza l'anello del quadro maniglia nella porta finché non si arresta.



39

21. Misurare lo spessore della porta.



40

Area	Spessore porta (mm)	Viti
S	38 - 53	M5×35
M	51 - 63	M5×40
M	62 - 73	M5×50
L	71 - 83	M5×60
L	82 - 93	M5×70
X	91 - 176	M5 X

22. Determinare le viti necessarie con lo spessore porta misurato.

23. Per X: far passare le viti attraverso la piastra di fissaggio lato interno e avvitare insieme al manicotto filettato e all'asta filettata.



41



42

24. Avvitare la parte interna e la parte esterna mediante le viti scelte (PH2).

**NOTA****Manicotti di riduzione per i fori da 14 mm già presenti**

I fori da 14 mm già presenti rendono difficoltoso il fissaggio sicuro di SmartHandle AX Advanced.

- Applicare i manicotti di riduzione in silicone inclusi nella fornitura nei fori già presenti, per ridurre il gioco.

- 43
 - 44
 - 45
 - 46
 - 47
 - 48
 25. Avvitare saldamente la vite senza testa della maniglia interna (TX15).
 26. Applicare una copertura con la tacca rivolta verso il basso sulla base della maniglia interna.
 27. Posizionare la cover in alto sulla piastra di fissaggio.
 28. Chiudere la cover in basso.
 29. Spingere la cover verso l'alto.
 30. Premere saldamente l'inserito.
 31. Applicare la maniglia esterna.
 32. Avvitare saldamente la maniglia esterna con la vite senza testa (TX15).
- ↳ La SmartHandle AX Advanced è completamente montata.

8. Smontaggio della maniglia (105/145)

- ✓ Chiave esagonale da 1,5 mm disponibile.
1. Smontare la maniglia procedendo nella sequenza opposta rispetto al montaggio.
 2. Allentare la cover flettendo verso l'esterno l'inserito con l'attrezzo speciale.
 3. Inserire una chiave esagonale da 1,5 mm nel foro dell'alloggiamento del quadro maniglia nel supporto del modulo.
 4. Girare la chiave esagonale dal lato sul quale si trova il foro e contemporaneamente tirare la maniglia esterna.
- ↳ La SmartHandle AX Advanced è smontata.

9. Sostituzione delle batterie**NOTA****Malfunzionamenti dovuti a contatto insufficiente o a scarichi diversi**

Superfici di contatto troppo piccole/contaminate o diverse batterie scariche possono portare a malfunzionamenti.

1. Utilizzare esclusivamente batterie autorizzate da SimonsVoss.
 2. Non toccare con le mani i contatti delle nuove batterie.
 3. Utilizzare guanti puliti e privi di grasso.
 4. Sostituire sempre tutte le batterie contemporaneamente.
- ✓ Attrezzo speciale a disposizione.
 - ✓ Guanti a disposizione.
1. Inserire l'attrezzo speciale nell'inserito della cover della parte elettronica.
 2. Con l'attrezzo speciale, flettere l'inserito della cover con cautela.
 3. Spingere la cover verso il basso.
 - ↳ La cover si sblocca.
 4. Rimuovere la cover.
 5. Con l'attrezzo speciale, sganciare la clip del modulo delle batterie.
 6. Rimuovere il modulo delle batterie.
 7. Con l'attrezzo speciale, sganciare la clip delle batterie.
 8. Rimuovere le batterie superiori.
 9. Sollevare la linguetta intermedia verso il bordo con cautela.
 10. Rimuovere le batterie inferiori.
 11. Inserire due batterie nuove in modo tale che i poli positivi si tocchino (CR2450).
 - ↳ Linguetta intermedia visibile sulle batterie inferiori.
 12. Inserire due batterie nuove in modo tale che i poli positivi si tocchino (CR2450).
 13. Agganciare nuovamente la clip delle batterie.
 14. Reinserire il modulo delle batterie nel supporto del modulo.
 15. Con l'attrezzo speciale, riagganciare la clip del modulo delle batterie.
 - ↳ La SmartHandle AX Advanced emette tre segnali acustici.
 16. Posizionare la cover in alto sulla piastra di fissaggio.
 17. Chiudere la cover in basso.
 18. Premere contemporaneamente la cover contro la porta e verso l'alto.
 - ↳ La cover si innesta.

19. Premere saldamente l'insero.



- ↳ Le batterie sono sostituite.

10. Dati tecnici

Range di temperature (esercizio)	da -25 °C a +60 °C
Tipo di batteria	4 × CR2450 3V al litio
Marca delle batterie	<ul style="list-style-type: none"> ■ Murata ■ Panasonic ■ Varta
Grado di protezione	Fino a IP66 (variante WP)

Emissioni radio

15,24 kHz - 72,03 kHz Solo per i codici articolo: SV-S3.*AM.G2*, SV-S3.*A.G2*, SI-S3.*LN*	10 dBµA/m (3 m distanza)
13,560006 MHz - 13,560780 MHz Solo per i codici articolo: SV-S3.*AM.G2*, SV-S3.*A.G2*, SI-S3.*M.WO*, SI-S3.*LN*	1,04 dBµA/m (3 m distanza)
868,000 MHz - 868,600 MHz / 869,700 MHz - 870,000 MHz Solo per i codici articolo: SI-S3.*M.WO*, SI-S3.*LN*	<25 mW ERP
2402 MHz - 2480 MHz Solo per i codici articolo: SV-S3.*AM.G2*, SV-S3.*A.G2*, SI-S3.*M.WO*, SI-S3.*LN*	2,5 mW

11. Dichiarazione di conformità

Het bedrijf SimonsVoss Technologies GmbH verklaart hierbij dat de artikelen (SI-S3.*M.VCN*, SV-S3.*M.G2*, SV-S3.*AM.G2*, SV-S3.*A.G2*, SI-S3.*M.WO*, SI-S3.*LN*) voldoet aan de volgende richtlijnen:

- 2014/53/UE -RED-
o per il Regno Unito: Normativa del Regno Unito 2017 n. 1206
-Apparecchiature radio-
- 2011/65/UE -RoHS-
o per il Regno Unito: Normativa del Regno Unito 2012 n. 3032 -RoHS-



Il testo integrale della dichiarazione di conformità UE è disponibile al seguente indirizzo Internet: www.simons-voss.com/it/certificati.html.

Il testo integrale della dichiarazione di conformità UK è disponibile al seguente indirizzo Internet: www.simons-voss.com/it/certificati.html.

12. Supporto e ulteriori informazioni

Materiale informativo/Documenti

<https://www.simons-voss.com/it/documenti.html>

<https://www.smartintego.com/int/home/infocenter/documentation>

Dichiarazioni di conformità

<https://www.simons-voss.com/it/certificati.html>

Informazioni sullo smaltimento

- Il dispositivo (SI-S3.*M.VCN*, SV-S3.*M.G2*, SV-S3.*AM.G2*, SV-S3.*A.G2*, SI-S3.*M.WO*, SI-S3.*LN*) non va smaltito fra i rifiuti domestici, ma conferito presso un centro di raccolta comunale per rifiuti elettronici speciali in conformità con la Direttiva Europea 2012/19/UE.
- Riciclare le batterie guaste o esauste ai sensi della Direttiva Europea 2006/66/CE.
- Osservare le disposizioni locali in materia di smaltimento speciale delle batterie.

- Conferire l'imballaggio presso un punto di raccolta ai fini del riciclaggio ecologico.



Supporto tecnico

+49 (0) 89 / 99 228 333

E-mail

support-simonsvoss@allegion.com

si-support-simonsvoss@allegion.com

FAQ

<https://faq.simons-voss.com/otrs/public/>

SimonsVoss Technologies GmbH, Feringastr. 4, D-85774 Unterfoehring, Germania

1. Generelle sikkerhedshenvisninger

Signalord: Mulige direkte virkninger i tilfælde af manglende overholdelse
ADVARSEL: Død eller alvorlig personskade (muligt, men usandsynligt), **FOR-**
SIGTIG: Mindre skade, **OPMÆRKSOMHED:** Materiel skade eller fejlfunktion,
BEMÆRK: Lidt eller ingen



ADVARSEL

Spærret adgang

Hvis komponenter er fejlagtigt monteret og/eller programmeret, kan adgang til en dør forblive spærret. For følgeskader, der skyldes spærret adgang, fx til personer, der er sårede eller i fare, tingsskader eller andre skader, hæfter SimonsVoss Technologies GmbH ikke!

Blokeret adgang gennem manipulation af produktet

Hvis du selv ændrer produktet, kan der opstå funktionsfejl, og adgang via en dør kan blokeres.

- Modificer kun produktet, når det er nødvendigt, og kun på den måde, der er beskrevet i dokumentationen.

Batteri må ikke indtages. Forbrændingsfare på grund af farlige stoffer

Dette produkt indeholder litium-knappceller. Hvis knapcellen sluges, kan det medføre alvorlige indre forbrændinger inden for to timer og dødsfald.

1. Opbevar nye og brugte batterier uden for børns rækkevidde.
2. Hvis batterirummet ikke kan lukkes ordentligt, må produktet ikke længe benyttes, og det opbevares uden for børns rækkevidde.
3. Hvis du tror, at batterier er blevet slugt eller befinder sig i en legemsdel, skal du straks søge lægehjælp.

Eksplodingsfare på grund af forkert batteritype

Isætning af den forkerte batteritype kan resultere i en eksplosion.

- Brug kun de batterier, der er specificeret i de tekniske data.



FORSIGTIG

Brandfare ved batterier

Batterierne kan udgøre en brand- eller forbrændingsfare ved forkert behandling.

1. Forsøg ikke at oplade, åbne, opvarme eller brænde batterierne.
2. Kortslut ikke batterierne.

OPMÆRKSOMHED

Beskadigelse på grund af elektrostatisk afladning (ESD) med huset åbent

Dette produkt indeholder elektroniske komponenter, som kan blive beskadiget på grund af elektrostatisk afladning.

1. Brug ESD-beskyttede arbejdsmaterialer (f.eks. jordforbindelsesbånd).
2. Opret jordforbindelse før arbejde, hvor du kan komme i kontakt med elektronikken. Indfat i denne forbindelse jordforbundne metaloverflader (f.eks. dørkarme, vandrør eller varmeventiler).

Beskadigelse på grund af væske

Dette produkt indeholder elektroniske og/eller mekaniske komponenter, som kan blive beskadiget på grund af alle typer væsker.

- Hold væsker væk fra elektronikken.

Beskadigelse på grund af aggressive rengøringsmidler

Produktets overflade kan blive beskadiget på grund af uegnede rengøringsmidler.

- Brug kun rengøringsmidler, der er velegnede til kunststof- og metaloverflader.

Beskadigelse på grund af mekanisk påvirkning

Dette produkt indeholder elektroniske komponenter, som kan blive beskadiget på grund af alle typer mekanisk påvirkning.

1. Undgå at berøre elektronikken.
2. Undgå at udsætte elektronikken for andre mekaniske påvirkninger.

Beskadigelse på grund af fejltlilslutning

Dette produkt indeholder elektroniske komponenter, som kan blive beskadiget på grund af fejltlilslutning af spændingskilden.

- Sørg for ikke at fejltlilslutte spændingskilden (batterier eller netdele).

Driftsforstyrrelse på grund af radiostøj

Dette produkt kan under visse omstændigheder påvirkes af elektromagnetiske eller magnetiske forstyrrelser.

- Montér eller anbring ikke produktet umiddelbart i nærheden af enheder, som kan medføre elektromagnetiske eller magnetiske forstyrrelser (strømforsyninger!).

Kommunikationsfejl på grund af metaloverflader

Dette produkt kommunikerer trådløst. Metaloverflader kan reducere produktets rækkevidde væsentligt.

- Montér eller anbring ikke produktet på eller i nærheden af metaloverflader.



BEMÆRK

Korrekt anvendelse

SimonsVoss-produkter er kun beregnet til åbning og lukning af døre og sammenlignelige genstande.

- Anvend ikke SimonsVoss-produkter til andre formål.

Funktionsfejl på grund af dårlig kontakt eller anden afladning

For små / forurenede kontaktområder eller forskellige afladede batterier kan føre til funktionsfejl.

1. Anvend kun batterier, som er frigivet af SimonsVoss.
2. Berør ikke de nye batteriers kontakter med hænderne.
3. Anvend rene og fedtfrie handsker.
4. Skift derfor altid alle batterier samtidigt.

Afvigende tidspunkter ved G2-lukninger

Den interne tidsenhed ved G2-lukninger har en teknisk betinget tolerance på op til ± 15 minutter om året.

Krævede kvalifikationer

Installation og idriftsættelse kræver specialiseret viden.

- Kun uddannet personale må installere og idriftsætte produktet.

Ændringer eller tekniske videreudviklinger kan ikke udelukkes og kan foretages uden forudgående varsel.

Den tyske sprogversion er den originale brugsanvisning. Andre sprog (udkast på kontraktspøget) er oversættelser af de originale instruktioner.

Læs og følg alle installations-, installations- og idriftsættelsesinstruktioner. Overfør disse instruktioner og eventuel vedligeholdelsesinstruktion til brugeren.

2. Produktspecifikke sikkerhedsanvisninger

OPMÆRKSOMHED

Vanskelig samling på grund af gevindbøsninger, der presses ud

Gevindbøsningerne i beslaget er monteret med prespasning Et for stort tryk, når beslaget skrues fast på fastgørelsespladen, kan få gevindbøsningerne til at glide ud af beslaget.

1. Tryk ikke på skruerne, når du skruer modulholderen fast.
2. Brug en finger på enderne af gevindbøsningerne til at holde imod, mens du skruer.

3. Leveringsomfang

- SmartHandle AX Advanced til traditionel montering 105/145.

- Specialværktøj

- Kort vejledning











Afhængigt af variant:

- Adaptersæt 7 mm firkant
- Adaptertylle 8,5 mm firkant
- Adaptertylle 10 mm firkant





4. Montering



5. Forbered døren (boreskabelon)

- ✓ Blyant eller ridsenål til stede.
 - ✓ Boremaskine til rådighed.
 - ✓ Der er et passende bor (Ø 7 mm) til rådighed.
 - ✓ PH2-skruetrækker til rådighed.
1. Sæt firkanten ind i indstikslåsen.
 
 2. Sæt boreskabelonen på firkanten.
 
 3. Juster boreskabelonen lodret ved hjælp af den påtrykte skala.
 4. Marker borehullerne med mærke 1.
 
 5. Fjern boreskabelonen, og drej den 180 grader.
 
 6. Sæt boreskabelonen på firkanten.
 
 7. Juster boreskabelonen lodret ved hjælp af den påtrykte skala.
 8. Markér borehullet med mærke 2.
 
 9. Fjern boreskabelonen og firkanten.
 
 10. Fjern indstikslåsen.
 
 11. Bor de nødvendige huller.
 
 12. Monter indstikslåsen.
 

6. Til dørtykkelse X: forbered gevindstænger og firkant

- ✓ Måleapparat til kalibre er tilgængeligt.
 - ✓ Sav er tilgængeligt.
 - ✓ PH2-skruetrækker til rådighed.
1. Mål dørens tykkelse.
 
 2. Til dørtykkelse X: Skru 50 mm skruer, gevindbøsninger og gevindstængerne sammen.
 
 3. For X: Marker savepunkterne på gevindstængerne og på firkanten.
 
 - 
 4. For X: Afkort gevindstængerne og firkanten med en egnet sav.
 

7. Monter beslaget

- ✓ Døren er forboret.

- ✓ PH2-skruetrækker til rådighed.
 - ✓ TX15-skruetrækker til rådighed.
 - ✓ Måleapparat til kalibre er tilgængeligt.
1. For ikke-MO: Indsæt blindcylindren.



BEMÆRK

Før blindcylindren med skruetrækker i hullet

Især ved tykke døre er det svært at placere blindcylindren korrekt.

1. Sæt en skruetrækker ind i hullet i blindcylindren.
2. Placer blindcylindren ved hjælp af skruetrækkeren.



19



20

2. For ikke-MO: Skru blindcylindren fast.



21

3. Indsæt firkantens beskyttelsesrør i fastgørelsespladen.



22

4. For 7 mm firkant: Placer adapterskoen i modulholderens firkantede hul.



23

5. Sæt modulholderen ind i fastgørelsespladen.



24

6. Skub modulholderen opad.



25

- ↳ Modulholderen klikker på plads.

7. Skru gevindbøsningerne på gevindboltene på fastgørelsespladen.
8. Skru modulholderen fast til fastgørelsespladen med 12 mm skruer (PH2).



26



27







9. Stik modulholderen med fastgørelsespladen ind i dørens yderside.



BEMÆRK

Reduktionsmuffer til eksisterende 14 mm huller

De eksisterende 14 mm huller gør det vanskeligt at fastgøre SmartHandle AX Advanced.

- Indsæt de medfølgende silikone-reduktionsmuffer i de eksisterende huller for at reducere sløret.
10. For 7 mm firkant: Placer adaptertyllen i det indvendige håndtag, så udsparingen vender mod skruetiften.
 
 11. Bestem den ønskede drejretning for dit indvendige håndtag.
 12. Indsæt fjederlelementet i overensstemmelse hermed.
 
 - 
 13. Anbring underlaget i den indvendige håndtagsenhed.
 
 14. Skru det indvendige håndtag sammen med gevindbøsningerne og 10 mm-skruerne fast til fastgørelsespladen (2,5 mm sekskantnøgle og PH2).
 
 - 
 15. Til 8,5 mm og 10 mm firkant: Skub adaptertyllen ind i midten af firkanten. Lav en fordybning i adaptertyllen med en hammer og en kørner for at forhindre, at den glider.
 



16. Mål firkantens samlede længde.



17. Bestem firkantens inderside (firkantens ende til midten af den første rille = 26 mm).

18. Bestem O-ringens placering med tabellen.



Område	Dørtykkelse (mm)	Firkantens længde (mm)	Ringens position
S	38 - <41	94	2
S	38 - <41	104	4
S	41 - <46	94	1
S	41 - <46	104	3
S	46 - <51	104	2
S	51 - 53	104	1
M	51 - <56	114	3
M	51 - <56	124	5
M	56 - <61	114	2
M	56 - <61	124	4
M	61 - <66	114	1
M	61 - <66	124	3
M	66 - <71	124	2
M	71 - 73	124	1
L	71 - <76	134	3
L	71 - <76	144	5
L	76 - <81	134	2
L	76 - <81	144	4
L	81 - <86	134	1
L	81 - <86	144	3
L	86 - <91	144	2
L	91 - 93	144	1
XL	91 - 176	O-ringens er 30-35 mm fra den afsavede ende af firkanten.	

19. Skub O-ringens ind i den beregnede rille.



20. Sæt firkanten med den ringfrie side så langt ind i døren, som den kan komme.



21. Mål dørens tykkelse.



Område	Dørtykkelse (mm)	Fastskruing
S	38 - 53	M5×35
M	51 - 63	M5×40
M	62 - 73	M5×50
L	71 - 83	M5×60
L	82 - 93	M5×70
X	91 - 176	M5 X

22. Bestem de nødvendige skruer ud fra den målte dørtykkelse.

23. Til X: Sæt skruerne gennem den indvendige fastgørelsesplade og skru dem sammen med gevindmuffen og gevindstangen.



24. Skru den indre del og den ydre del (PH2) sammen med de leverede skruer.

**BEMÆRK****Reduktionsmuffer til eksisterende 14 mm huller**

De eksisterende 14 mm huller gør det vanskeligt at fastgøre SmartHandle AX Advanced.

- Indsæt de medfølgende silikone-reduktionsmuffer i de eksisterende huller for at reducere sløret.



25. Spænd gevindskruen på det indvendige håndtag (TX15).



26. Sæt et dæksel med indhakked nedad på bunden af det indvendige håndtag.



27. Placer dækslet oven på fastgørelsespladen.



28. Klap dækslet ned.



29. Skub dækslet opad.



30. Tryk indlægget fast.



31. Sæt det udvendige håndtag på.



32. Brug gevindskruen til at skru det udvendige håndtag (TX15) fast.



- SmartHandle AX Advanced færdigmonteret.

**8. Afmontering af beslag (105/145)**

- Anvend 1,5 mm unbrakonøgle.

- Afmonter beslaget i omvendt rækkefølge i forhold til monteringen.
- Løsn dækslet ved at bøje indlægget udad med specialværktøjet.
- Sæt en 1,5 mm sekskantnøgle ind i det dertil beregnede hul i firkantholderen i modulholderen.



- Bøj sekskantnøglen til den side, hvor hullet er placeret, og træk samtidig i det udvendige håndtag.



- SmartHandle AX Advanced er afmonteret.

9. Udskiftning af batterier



BEMÆRK

Funktionsfejl på grund af dårlig kontakt eller anden afladning

For små / forurenede kontaktområder eller forskellige afladede batterier kan føre til funktionsfejl.

1. Anvend kun batterier, som er frigivet af SimonsVoss.
2. Berør ikke de nye batteriers kontakter med hænderne.
3. Anvend rene og fedtfrie handsker.
4. Skift derfor altid alle batterier samtidigt.

- ✓ Specialværktøj er tilgængeligt.
- ✓ Handsker er tilgængeligt.

1. Sæt specialværktøjet ind i dækslet på elektroniksiden.



60

2. Brug specialværktøjet til at bøje dækslet forsigtigt op.



61

3. Skub dækslet ned.



62

- ↳ Dækslet er ikke låst op.

4. Fjern dækslet.



63

5. Løsn batterimodulets clips med specialværktøjet.



64

6. Fjern batterimodulet.



65

7. Løsn batteriklippen med specialværktøjet.



66

8. Fjern de øverste batterier.



67

9. Bøj forsigtigt den mellemliggende fjeder til siden.

10. Fjern de nederste batterier.



68

11. Sæt to nye batterier i med de positive poler i berøring (type CR2450).



69

- ↳ Den mellemliggende fjeder er synlig over de nederste batterier.

12. Sæt to nye batterier i med de positive poler i berøring (type CR2450).



70

13. Sæt batteriklippen på plads igen.



71

14. Sæt batterimodulet tilbage i modulholderen.



72

15. Brug specialværktøjet til at sætte batterimodulets clips på plads igen.



73

- ↳ SmartHandle AX Advanced bipper tre gange.

16. Placer dækslet oven på fastgørelsespladen.



74

17. Klap dækslet ned.



75

18. Tryk dækslet mod døren og skub det samtidig opad.



76

- ↳ Dækslet klikkes på plads.

19. Tryk indlægget fast.



77

- ↳ Batterierne er udskiftet.

10. Tekniske data

Temperaturområde (drift)	-25 °C til +60 °C
Batteritype	4 × CR2450 3V lithium
Batteriproducent	<ul style="list-style-type: none"> ■ Murata ■ Panasonic ■ Varta
IP-kapslingsklasse	Op til IP66 (WP-variant)

Radio emissions

15,24 kHz - 72,03 kHz Kun for artikelnumre: SV-S3.*AM.G2*, SV-S3.*A.G2*, SI-S3.*LN*	10 dBμA/m (3 m afstand)
13,560006 MHz - 13,560780 MHz Kun for artikelnumre: SV-S3.*AM.G2*, SV-S3.*A.G2*, SI-S3.*M.WO*, SI-S3.*LN*	1,04 dBμA/m (3 m afstand)
868,000 MHz - 868,600 MHz / 869,700 MHz - 870,000 MHz Kun for artikelnumre: SI-S3.*M.WO*, SI-S3.*LN*	<25 mW ERP
2402 MHz - 2480 MHz Kun for artikelnumre: SV-S3.*AM.G2*, SV-S3.*A.G2*, SI-S3.*M.WO*, SI-S3.*LN*	2,5 mW

11. Overensstemmelseserklæring

Hermed erklærer SimonsVoss Technologies GmbH at varen (SI-S3.*M.VCN*, SV-S3.*M.G2*, SV-S3.*AM.G2*, SV-S3.*A.G2*, SI-S3.*M.WO*, SI-S3.*LN*) overholder følgende retningslinjer:

- 2014/53/EU -RED- eller for Storbritannien: UK lovbekendtgørelse 2017 nr. 1206 -Radioudstyr-
- 2011/65/EU -RoHS- eller for Storbritannien: UK lovbekendtgørelse 2012 nr. 3032 -RoHS-



Den fulde ordlyd af EU-overensstemmelseserklæringen er tilgængelig på følgende internetadresse: www.simons-voss.com/dk/certifikater.html. Den fulde ordlyd af UK-overensstemmelseserklæringen er tilgængelig på følgende internetadresse: www.simons-voss.com/dk/certifikater.html.

12. Hjælp og flere oplysninger

Infomateriale/dokumenter

<https://www.simons-voss.com/dk/dokumenter.html>

<https://www.smartintego.com/int/home/infocenter/documentation>

Overensstemmelseserklæringer

<https://www.simons-voss.com/dk/certifikater.html>

Oplysninger om bortskaffelse

- Enheden (SI-S3.*M.VCN*, SV-S3.*M.G2*, SV-S3.*AM.G2*, SV-S3.*A.G2*, SI-S3.*M.WO*, SI-S3.*LN*) må ikke bortskaffes med husholdningsaffaldet, men skal afleveres på den kommunale affaldsplads, jf. det europæiske direktiv 2012/19/EU.
- Brugte eller defekte batterier skal genanvendes jf. det europæiske direktiv 2006/66/EG.
- Overhold de lokale bestemmelser for separat bortskaffelse af batterier.
- Aflever emballagen til miljørigtig genanvendelse.



78

Teknisk support

+49 (0) 89 / 99 228 333

e-mail

support-simonsvoss@allegion.com
si-support-simonsvoss@allegion.com

FAQ

<https://faq.simons-voss.com/otrs/public.pl>

SimonsVoss Technologies GmbH, Feringastr. 4, D-85774 Unterföhring,
Tyskland

1. Allmänna säkerhetsanvisningar

Signalord: Eventuella omedelbara effekter av bristande efterlevnad
WARNING: Död eller allvarlig skada (möjligt, men osannolikt), **OBSERVERA:** Liten skada, **OBS:** Skador på egendom eller fel, **INFO:** Låg eller ingen



WARNING

Tillgång spärrad

Felaktigt installerade och/eller programmerade komponenter kan leda till att dörrar spärras. SimonsVoss Technologies GmbH ansvarar inte för konsekvenserna av felaktig installation såsom spärrat tillträde till skadade personer eller personer i risksituationer, materiella skador eller andra typer av skador.

Blockerad åtkomst genom manipulering av produkten

Om du ändrar produkten på egen hand kan fel uppstå och åtkomst via en dörr kan blockeras.

- Ändra endast produkten vid behov och endast på det sätt som beskrivs i dokumentationen.

Swälj inte batteriet. Risk för brännskador på grund av farliga ämnen.

Den här produkten innehåller litiumknappcells batterier. Om man råkar svälja ett knappcells batteri kan allvarliga inre brännskador uppstå inom bara två timmar vilket i sin tur kan leda till döden.

1. Förvara nya och förbrukade batterier utom räckhåll för barn.
2. Upphör att använda produkten och förvara den utom räckhåll för barn om batterilocket inte går att stänga ordentligt.
3. Uppsök omedelbart läkare om du misstänker att batterier har svälts eller befinner sig i någon kroppsdels.

Explosionsrisk på grund av felaktig batterityp

Att sätta i fel typ av batteri kan leda till en explosion.

- Använd endast de batterier som anges i de tekniska data.



OBSERVERA

Brandrisk som utgår från batterier

De isatta batterierna kan orsaka brand eller brännskador om de hanteras på ett felaktigt sätt.

1. Försök inte att ladda upp, öppna eller värma upp batterierna.
2. Kortslut inte batterierna.

OBS

Skador på grund av elektrostatisk urladdning (ESD) när höljet är öppet

Den här produkten innehåller elektroniska komponenter som kan skadas av elektrostatiska urladdningar.

1. Använd alltid ESD-anpassat arbetsmaterial (t.ex. jordningsarmband).
2. Jorda dig före alla arbeten där du kan komma i kontakt med elektronik. Det gör du genom att fatta tag i en jordad metallyta (såsom dörrkarmar, vattenrör eller värmeventiler).

Skada på grund av vätskor

Den här produkten innehåller elektroniska och/eller mekaniska komponenter som kan skadas av alla typer av vätskor.

- Låt inte elektroniken komma i kontakt med vätskor.

Skada på grund av aggressiva rengöringsmedel

Ytan på den här produkten kan skadas om olämpliga rengöringsmedel används.

- Använd endast rengöringsmedel som lämpar sig för plast- och metalltytor.

Skada på grund av mekanisk påverkan

Den här produkten innehåller elektroniska komponenter som kan skadas av alla typer av mekanisk påverkan.

1. Undvik att vidröra elektroniken.
2. Undvik annan mekanisk påverkan på elektroniken.

Skada på grund av polvändning

Den här produkten innehåller elektroniska komponenter som kan skadas på grund av polvändning i spänningskällan.

- Vänd inte spänningskällans poler (batterier resp. nätdelar).

Driftstörning på grund av radiostörning

Den här produkten kan i vissa fall påverkas av elektromagnetiska eller magnetiska störningar.

- Produkten ska inte monteras eller placeras i omedelbar närhet av utrustning som kan orsaka elektromagnetiska eller magnetiska störningar (switchade nätaggregat!).

Kommunikationsstörning på grund av metalltytor

Den här produkten kommunicerar trådlöst. Metalltytor kan minska produktens räckvidd avsevärt.

- Produkten ska inte monteras eller placeras på eller i närheten av metalltytor.



INFO

Avsedd användning

SimonsVoss-produkter är uteslutande avsedda för öppning och stängning av dörrar och liknande.

- Använd inte SimonsVoss-produkter för andra syften.

Funktionsstörningar på grund av dålig dålig kontakt eller annan urladdning

För små / kontaminerade kontaktytor eller olika urladdade batterier kan leda till funktionsstörningar.

1. Används endast batterier som är godkända av SimonsVoss.
2. Vidrör inte de nya batteriernas kontakter med händerna.
3. Använd rena och fettfria handskar.
4. Byt alltid alla batterier samtidigt.

Avvikande tider vid G2-lås

G2-låsens interna tidsenhet har en tekniskt betingad tolerans på upp till ± 15 minuter per år.

Kvalifikationer krävs

Installation och idrifttagning kräver specialiserad kunskap.

- Endast utbildad personal får installera och driftsätta produkten.

Ändringar eller teknisk vidareutveckling kan inte uteslutas och kan komma att genomföras utan föregående meddelande om detta.

Den tyska språkversionen är den ursprungliga bruksanvisningen. Andra språk (utarbetade på kontraktsspråket) är översättningar av originalinstruktionerna.

Läs och följ alla installations-, installations- och driftsinstruktioner. Skicka dessa instruktioner och alla underhållsinstruktioner till användaren.

2. Produktspecifika säkerhetsanvisningar

OBS

Försvårad montering på grund av att gänghylsor har tryckts ut

Gänghylsorna i handtaget är monterade med en presspassning. Om man trycker för hårt när handtaget skruvas fast på fixeringsplattan kan leda till att gänghylsorna glider på handtaget.

1. Tryck inte på skruvarna när modulhållaren skruvas fast.
2. Håll emot med ett finger på gänghylsornas ändrar vid fastskruvning.

3. Leveransomfång

- SmartHandle AX Advanced för konventionell montering 105/145.

- Specialverktyg

- Snabbguide

Beroende på variant:











- Adaptersats 7 mm-fyrkant

- Adapterhylsa 8,5 mm-fyrkant
- Adapterhylsa 10 mm-fyrkant





4. Uppbyggnad



5. Förbereda dörr (borrschablon)

- ✓ Stift eller ritsnål finns.
 - ✓ Borrmaskin finns.
 - ✓ Lämpligt borrstål (Ø 7 mm).
 - ✓ PH2-skruvmejsel finns.
1. Stick in fyrkanten i instickslåset.
 
 2. Sätt på borrschablonen på fyrkanten.
 
 3. Rikta in borrschablonen lodrätt med hjälp av den påtryckta skalan.
 4. Markera borrhålen med markering 1.
 
 5. Avlägsna borrschablonen och vrid den 180 grader.
 
 6. Sätt på borrschablonen på fyrkanten.
 
 7. Rikta in borrschablonen lodrätt med hjälp av den påtryckta skalan.
 8. Markera borrhålet med markering 2.
 
 9. Ta bort borrschablonen och fyrkanten.
 
 10. Demontera instickslåset.
 
 11. Borra de hål som behövs.
 
 12. Montera instickslåset.
 

6. För dörrtjocklek X: Förbereda gångstänger och fyrkant

- ✓ Mätare för kalibreringsmått finns.
 - ✓ Såg finns.
 - ✓ PH2-skruvmejsel finns.
1. Mät dörrtjockleken.
 
 2. För dörrtjocklek X: Skruva samman 50 mm-skruvorna, gånghyslorna och gångstängerna.
 
 3. För X: Markera sågställena på gångstängerna och fyrkanten.
 
 4. För X: Korta av gångstängerna och fyrkanten med en lämpliga såg.
 
 18.
 

7. Montera handtag

- ✓ Dörr förborrad.
- ✓ PH2-skruvmejsel finns.

- ✓ TX15-skruvmejsel finns.
 - ✓ Mätare för kalibreringsmått finns.
1. För icke-MO: Sätt in blindcylindern.



INFO

För in blindcylindern i hålet med skruvmejseln.

Särskilt om dörrarna är tjocka är det svårt att positionera blindcylindern korrekt.

1. Sätt in en skruvmejseln i hålet för blindcylindern.
2. Positionera blindcylindern med hjälp av skruvmejseln.



2. För icke-MO: Skruva fast blindcylindern.



3. Sätt in fyrkantsskyddsroret i fixeringsplattan.



4. För 7 mm-fyrkant: Sätt i adapterskon i modulhållarens fyrkantsfäste.



5. Sätt in modulhållaren i fixeringsplattan.



6. Skjut modulhållaren uppåt.



- ↳ Modulhållaren hakar i.

7. Skruva på gånghyslorna på fixeringsplattans gängbultar.

8. Skruva fast modulhållaren på fixeringsplattan med 12 mm-skruvorna (PH2).



9. Sätt in modulhållaren med fixeringsplattan på dörrens ytersida.











INFO

Reduceringshyslor för befintliga 14 mm-hål

Redan befintliga 14 mm-hål försvårar säker montering av SmartHandle AX Advanced.

- Sätt i de medföljande reduceringshyslorna av silikon i de befintliga hålen, för att minska spelet.

10. För 7 mm-fyrkant: Sätt i adapterhylsan i innerhandtaget så att ursparningen är vänd mot stoppskruven.
 
11. Fastställ önskad vridriktning för innerhandtaget.
12. Sätt i fjäderelementet enligt motsvarande.
 
30.
 
13. Sätt in underlägget i innerhandtagsenheten.
 
14. Skruva fast innerhandtaget tillsammans med gånghyslorna och 10 mm-skruvorna på fixeringsplattan (2,5 mm-sexkantnyckel och PH2).
 
33.
 
15. För 8,5 mm- och 10 mm-fyrkant: Skjut in adapterhylsan i mitten av fyrkanten. Gör en fördjupning i adapterhylsan med en körnare och hammare för att förhindra att den glider.
 
35.
 

16. Mät fyrkantens totallängd.



36

17. Fastställ fyrkantens insida (fyrkantensände till mitten av första spår = 26 mm).

18. Bestäm O-ringens position med tabellen.



37

Område	Dörrtjocklek (mm)	Fyrkantslängd (mm)	Ringposition
S	38-< 41	94	2
S	38-< 41	104	4
S	41-< 46	94	1
S	41-< 46	104	3
S	46-< 51	104	2
S	51-53	104	1
M	51-< 56	114	3
M	51-< 56	124	5
M	56-< 61	114	2
M	56-< 61	124	4
M	61-< 66	114	1
M	61-< 66	124	3
M	66-< 71	124	2
M	71-73	124	1
L	71-< 76	134	3
L	71-< 76	144	5
L	76-< 81	134	2
L	76-< 81	144	4
L	81-< 86	134	1
L	81-< 86	144	3
L	86-< 91	144	2
L	91-93	144	1
XL	91-176	O-ringen ligger 30-35 mm från fyrkantens avsågade ände.	

19. Skjut på O-ringen på det beräknade spåret.



38

20. Skjut in fyrkanten med den ringfria sidan till anslag i dörren.



39

21. Mät dörrtjockleken.



40

Område	Dörrtjocklek (mm)	Skruva
S	38-53	M5×35
M	51-63	M5×40
M	62-73	M5×50
L	71-83	M5×60
L	82-93	M5×70
X	91-176	M5 X

22. Bestäm vilka skruvar som behövs utifrån den uppmätta dörrtjockleken.
23. För X: Sätt i skruvarna genom den invändiga fixeringsplattan och skruva ihop den med gängmuffen och gängstången.



41



42

24. Skruva samman innerdelen och ytterdelen med de fastställda skruvarna (PH2).



INFO

Reduceringshylsor för befintliga 14 mm-hål

Redan befintliga 14 mm-hål försvårar säker montering av SmartHandle AX Advanced.

- Sätt i de medföljande reduceringshylsorna av silikon i de befintliga hålen, för att minska spelet.



43



44



45



46



47



48

25. Skruva fast innerhandtagets stoppskruv (TX15).



49

26. Sätt fast ett skydd på innerhandtagets bas med ursparningen vänd nedåt.



50

27. Sätt på kåpan upptill på fixeringsplattan.



51

28. Fäll kåpan nedåt.



52

29. Skjut kåpan uppåt.



53

30. Tryck fast inlägget.



54

31. Sätt fast ytterhandtaget.



55

32. Skruva fast ytterhandtaget med stoppskruven (TX15).



56

- ↳ SmartHandle AX Advanced är färdigmonterat.



57

8. Demontera handtag (105/145)

- ✓ 1,5 mm sexkantsnyckel finns.

1. Demontera handtaget i omvänd ordningsföljd jämfört med montering.
2. Lossa kåpan genom att böja inlägget utåt med hjälp av specialverktyget.
3. Sätt i en 1,5 mm-insexnyckel i hålet på fyrkantensfästet i modulhållaren.



58

4. Böj insexnyckeln åt den sida där hålet sitter och dra samtidigt i ytterhandtaget.



59

- ↳ SmartHandle AX Advanced har demonterats.

9. Byt batterier.



INFO

Funktionsstörningar på grund av dålig dålig kontakt eller annan urladdning

För små / kontaminerade kontaktytor eller olika urladdade batterier kan leda till funktionsstörningar.

1. Används endast batterier som är godkända av SimonsVoss.
2. Vidrör inte de nya batteriernas kontakter med händerna.
3. Använd rena och fettfria handskar.
4. Byt alltid alla batterier samtidigt.

- ✓ Specialverktyg finns.
- ✓ Handskar finns.

1. Sätt i specialverktyget i kåpinlägget på elektroniksidan.



60

2. Bøj försiktigt upp kåpinlägget med specialverktyget.



61

3. Skjut kåpan nedåt.



62

↳ Kåpan är lossad.

4. Avlägsna kåpan.



63

5. Lossa batterimodulens klämmor med specialverktyget.



64

6. Avlägsna batterimodulen.



65

7. Lossa batteriets klämmor med specialverktyget.



66

8. Ta ur de övre batterierna.



67

9. Bøj mellanfjädern försiktigt åt sidan.

10. Ta ur de nedre batterierna.



68

11. Sätt i två nya batterier så att pluspolerna vidrör varandra (typ CR2450).



69

↳ Mellanfjädern är synlig ovanför de nedre batterierna.

12. Sätt i två nya batterier så att pluspolerna vidrör varandra (typ CR2450).



70

13. Haka i batteriklämmorna igen.



71

14. Sätt tillbaka batterimodulen i modulhållaren.



72

15. Haka i batterimodulens klämmor med specialverktyget.



73

↳ SmartHandle AX Advanced piper tre gånger.

16. Sätt på kåpan upptill på fixeringsplattan.



74

17. Fäll kåpan nedåt.



75

18. Tryck kåpan mot dörren och skjut den samtidigt uppåt.



76

↳ Kåpan hakar i.

19. Tryck fast inlägget.



77

↳ Batterierna är bytta.

10. Tekniska data

Temperaturområde (drift)	-25 °C till +60 °C
Batterityp	4× CR2450 3 V litium
Batteritillverkare	<ul style="list-style-type: none"> ■ Murata ■ Panasonic ■ Varta
IP-kapslingsklass	Upp till IP66 (WP-variant)

Utsläpp radio

15,24 kHz - 72,03 kHz Endast för artikelnummer: SV-S3.*AM.G2*, SV-S3.*A.G2*, SI-S3.*LN*	10 dBµA/m (3 m avstånd)
13,560006 MHz - 13,560780 MHz Endast för artikelnummer: SV-S3.*AM.G2*, SV-S3.*A.G2*, SI-S3.*M.WO*, SI-S3.*LN*	1,04 dBµA/m (3 m avstånd)
868,000 MHz - 868,600 MHz / 869,700 MHz - 870,000 MHz Endast för artikelnummer: SI-S3.*M.WO*, SI-S3.*LN*	<25 mW ERP
2402 MHz - 2480 MHz Endast för artikelnummer: SV-S3.*AM.G2*, SV-S3.*A.G2*, SI-S3.*M.WO*, SI-S3.*LN*	2,5 mW

11. Försäkrän om överensstämmelse

Häri förklarar SimonsVoss Technologies GmbH att varan (SI-S3.*M.VCN*, SV-S3.*M.G2*, SV-S3.*AM.G2*, SV-S3.*A.G2*, SI-S3.*M.WO*, SI-S3.*LN*) uppfyller följande riktlinjer:

- 2014/53/EU -RED- eller för Storbritannien: Förenade kungarikets lag 2017 nr 1206 -Radioutrustning-
- 2011/65/EU -RoHS- eller för Storbritannien: Förenade kungarikets lag 2012 nr 3032 -RoHS-



Den fullständiga texten till EU-försäkrän om överensstämmelse finns på följande internetadress: www.simons-voss.com/se/certifikat.html.
Den fullständiga texten till UK-försäkrän om överensstämmelse finns på följande internetadress: www.simons-voss.com/se/certifikat.html.

12. Hjälp och ytterligare information

Infomaterial/dokument

<https://www.simons-voss.com/se/dokument.html>

<https://www.smartintego.com/int/home/infocenter/documentation>

Försäkringar om överensstämmelse

<https://www.simons-voss.com/se/certifikat.html>

Avfallshantering

- Produkten (SI-S3.*M.VCN*, SV-S3.*M.G2*, SV-S3.*AM.G2*, SV-S3.*A.G2*, SI-S3.*M.WO*, SI-S3.*LN*) får inte slängas i hushållssoporna utan ska lämnas in på en kommunal uppsamlingsplats för elektriskt och elektroniskt avfall i enlighet med direktiv 2012/19/EU.
- Defekta eller uttjänta batterier ska återvinnas i enlighet med direktiv 2006/66/EG.
- Beakta gällande lokala bestämmelser gällande separat bortskaftande av batterier.
- Avfallshanterar förpackningsmaterial på ett miljövänligt sätt.



78

Teknisk support

+49 (0) 89 / 99 228 333

support-simonsvoss@allegion.com

si-support-simonsvoss@allegion.com

FAQ

<https://faq.simons-voss.com/otrs/public.pl>

SimonsVoss Technologies GmbH, Feringastr. 4, D-85774 Unterföhring,
Tyskland

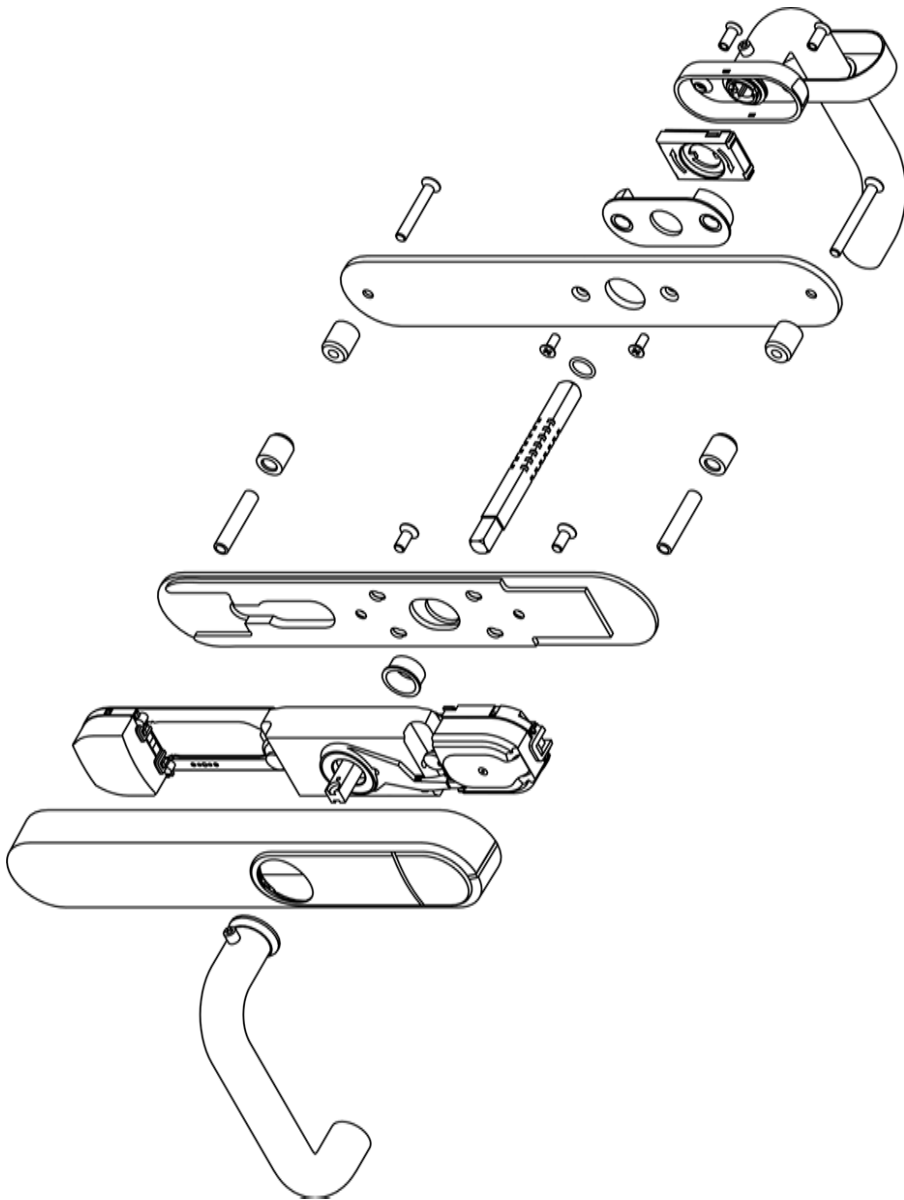

© 2024, SimonsVoss Technologies GmbH, Unterföhring

All rights are reserved. Text, images and diagrams are protected under copyright law.

The content of this document must not be copied, distributed or modified. You can find more information on our website. Subject to technical changes.

SimonsVoss and MobileKey are registered brands belonging to SimonsVoss.

SimonsVoss
technologies

Made in Germany

A BRAND OF

