

30  
60

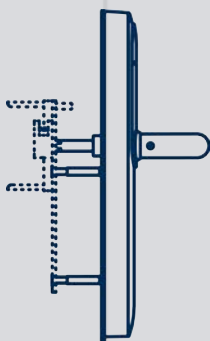

DE Kurzanleitung  
EN Quick Guide  
FR Guide abrégé  
NL Korte handleiding  
IT Guida breve  
DK Kort vejledning  
SE Snabbguide

BS25.990618  
11.03.2024



**SmartHandle AX Advanced  
Panic fitting with wide  
cover**

**Simons**  **Voss**  
technologies

Abbildungen/Images .....	3
deutsch .....	28
english .....	32
français .....	36
nederlands .....	40
italiano .....	44
dansk .....	48
svensk .....	52



#### 4. Structure with backplate (\*PS\*)

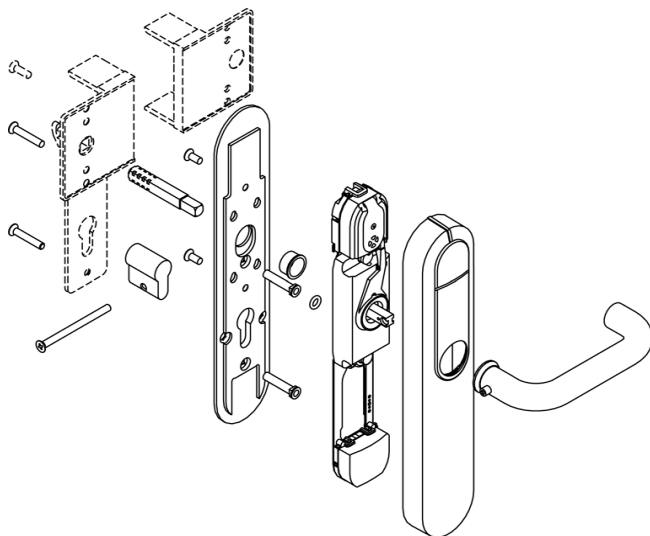

Inside

Outside



#### 5. Structure with round escutcheon (\*PO\*)

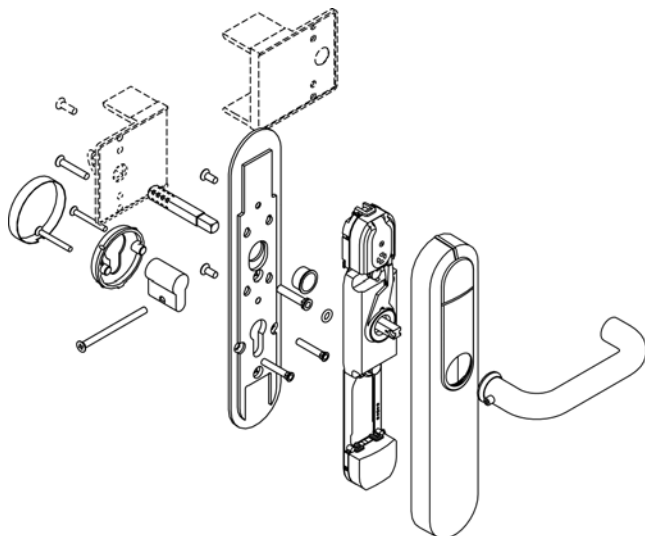

Inside

Outside

### 6. Prepare door (drilling template)



PH2



Ø7.0



Ø6.0

3



PH2

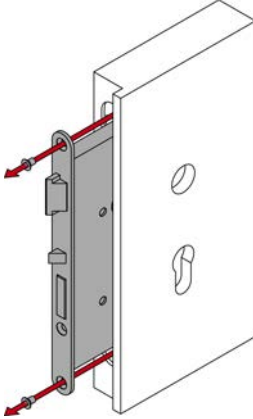

4

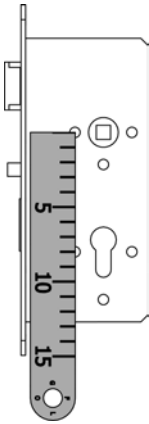

5



PH2

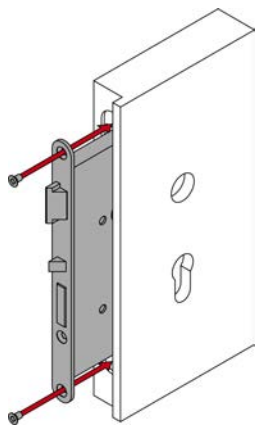

6

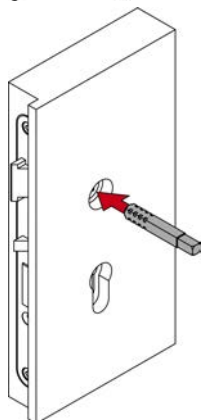

7

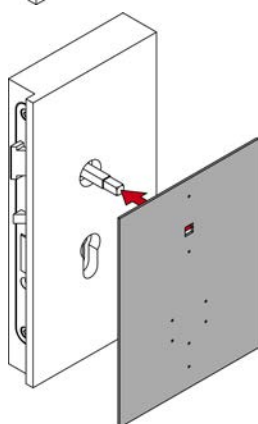

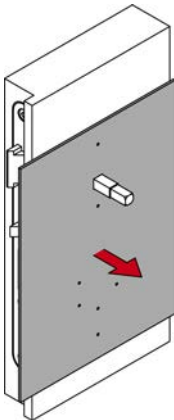
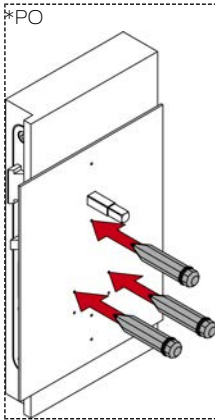
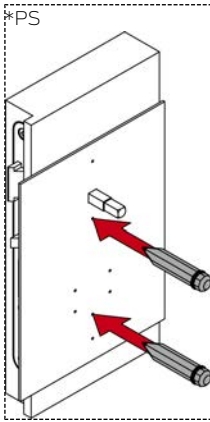

11

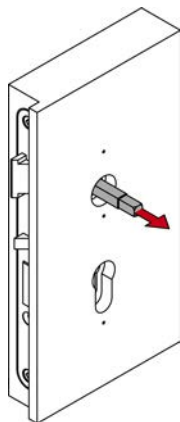

12



PH2

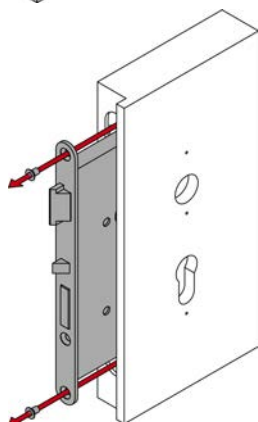

13



Ø7.0

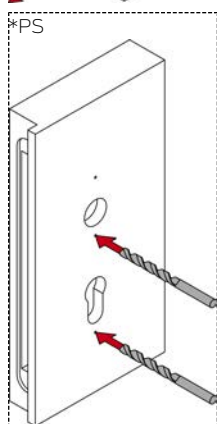

14

Ø6.0

Ø7.0

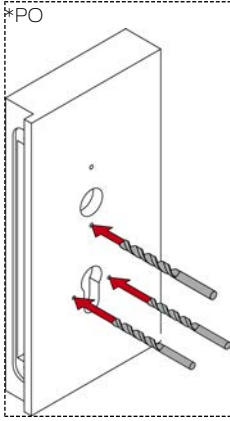

15



PH2

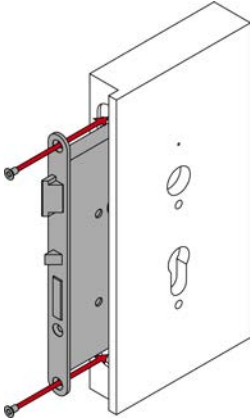



## 7. Installing the fitting



PH2



TX25



TX15

16

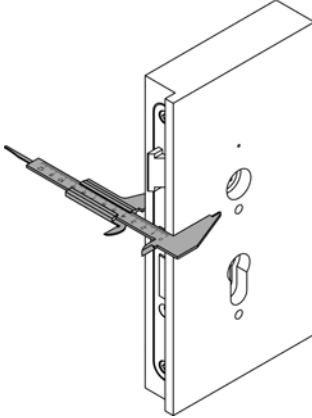

17

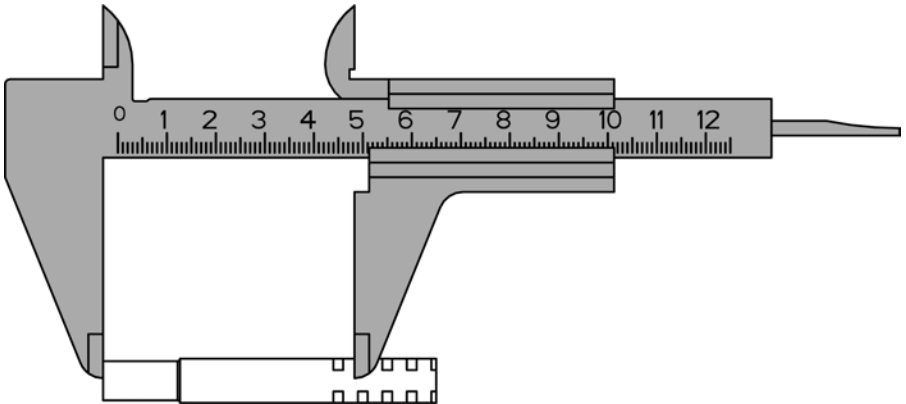

*PS* (with backplate)		*PO* (with round escutcheon)	
BKS (bar handle)	Door thickness – 27.8 ± 1.5 mm	BKS (push bar)	Door thickness + 36.8 ± 2.5 mm
BKS (push bar)	Door thickness – 36.8 ± 2.5 mm		
CISA 8 mm spindle	Door thickness – 27.3 ± 0.5 mm		
CISA 9 mm spindle	Door thickness – 19.3 ± 0.5 mm		

18

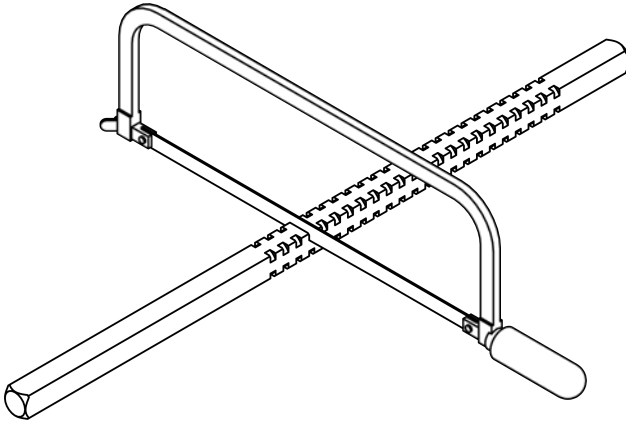

19

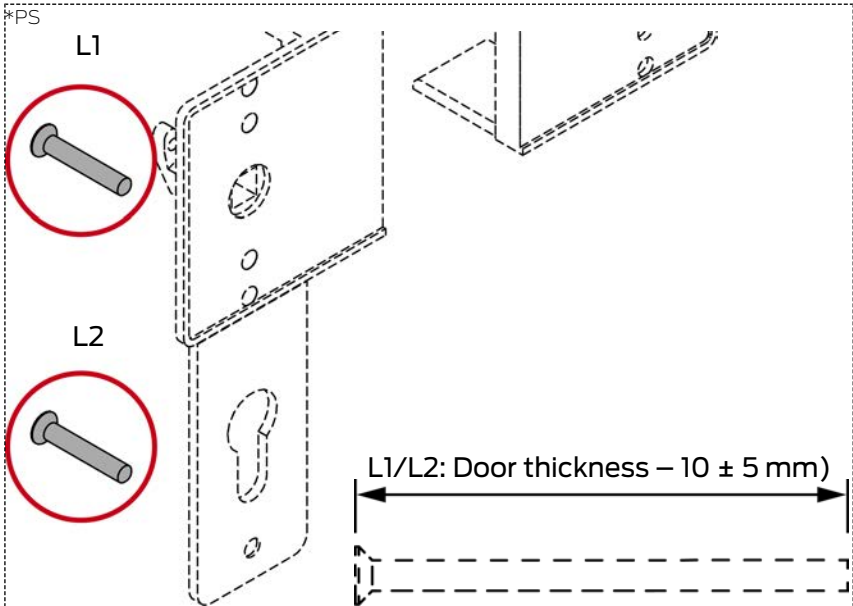

20

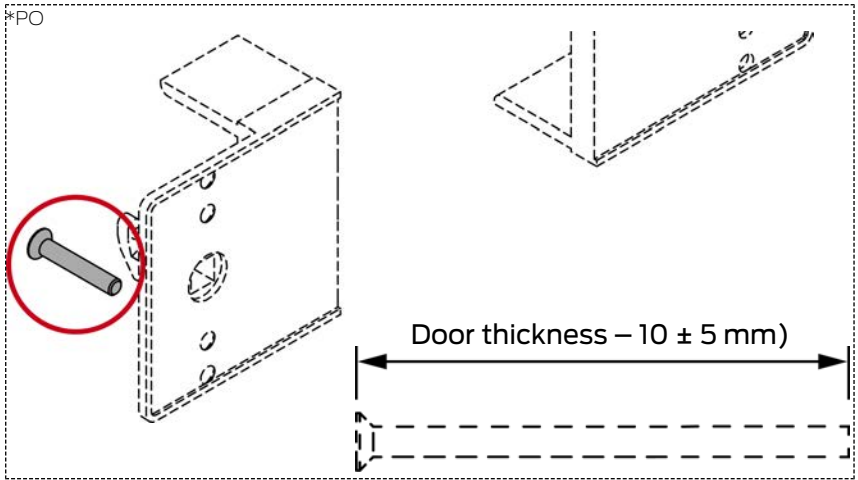

21

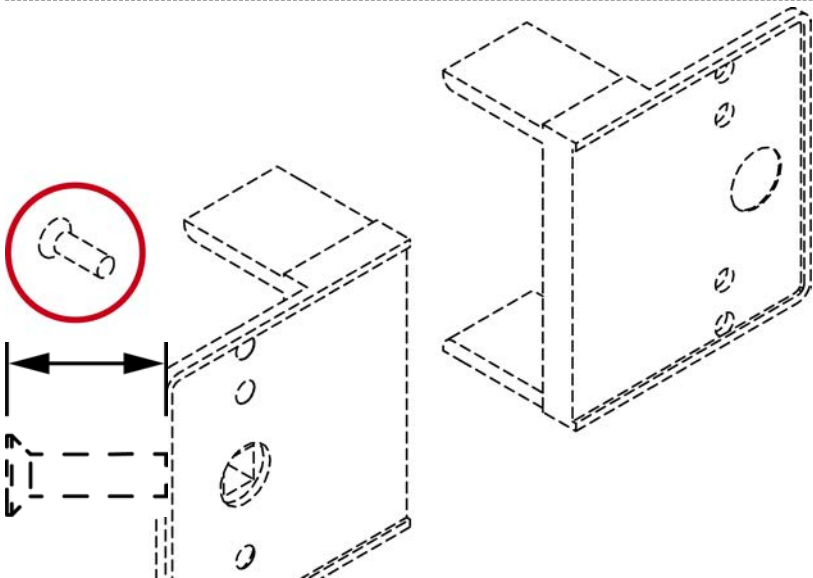

See panic bar manufacturer documentation

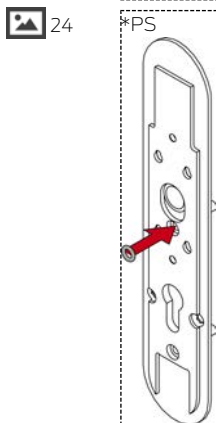
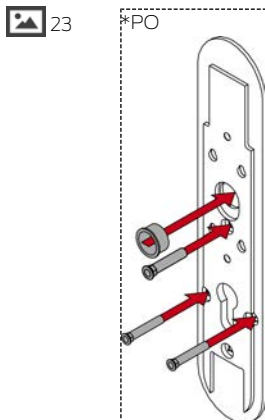
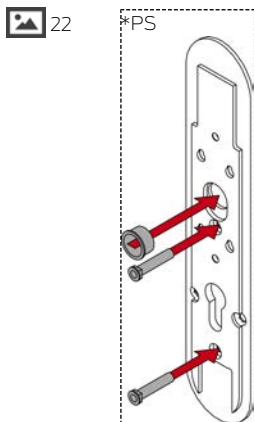

25



26



27

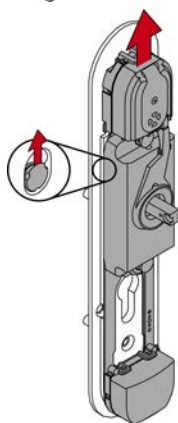

28



 29



PH2

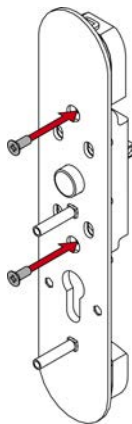

 30

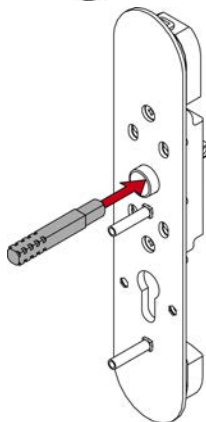

 31

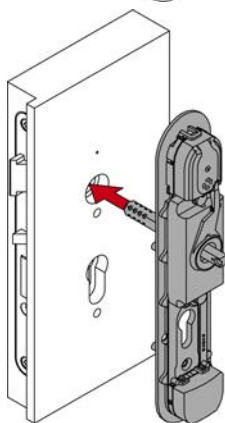

32

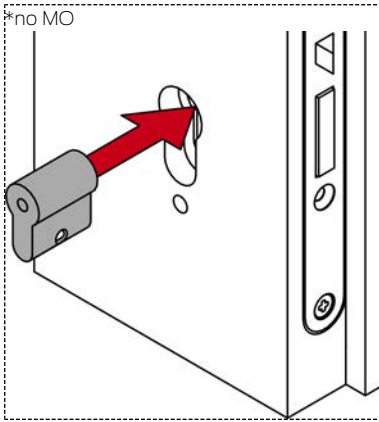

33



PH2

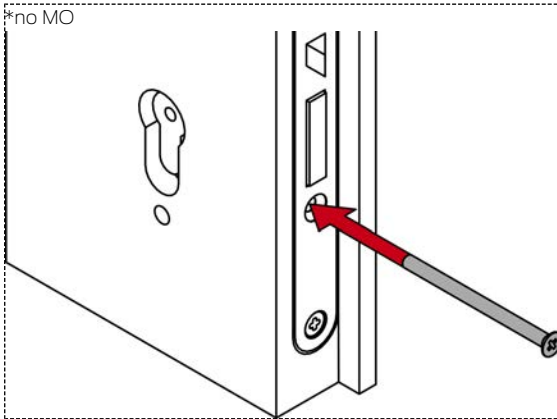

34

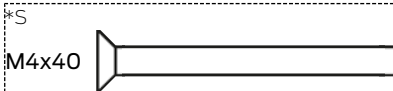

35

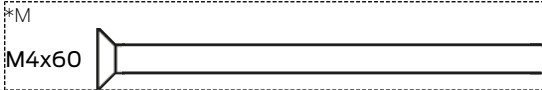

36

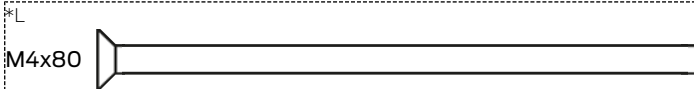

37

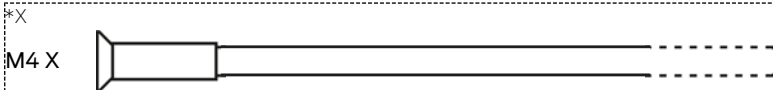

38



PH2

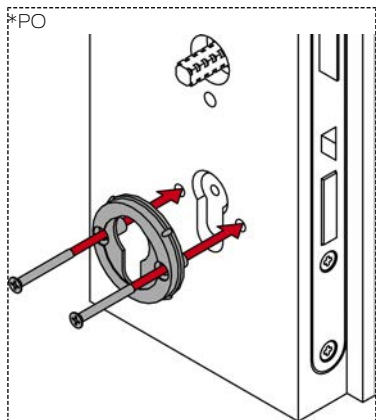

39

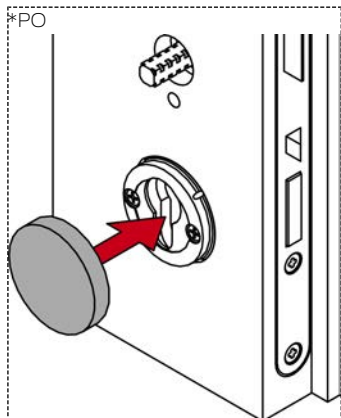

40



TX25

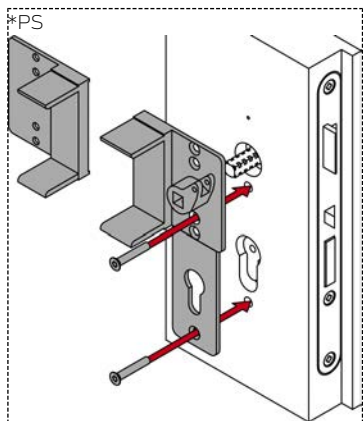



41



TX25

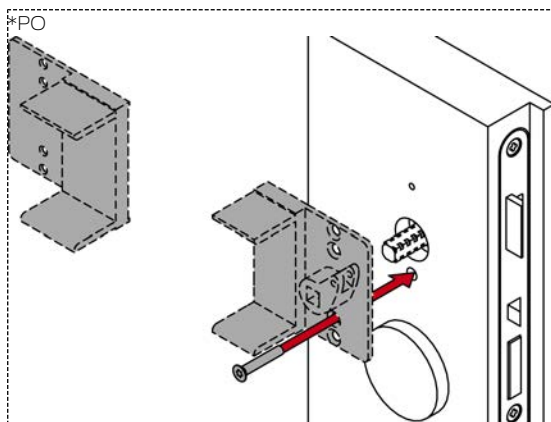

42

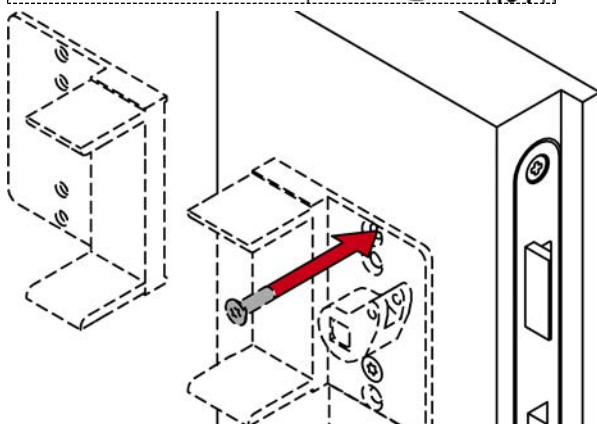

43

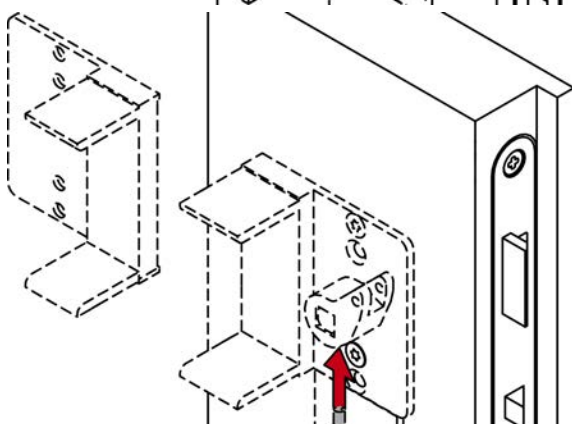

 44

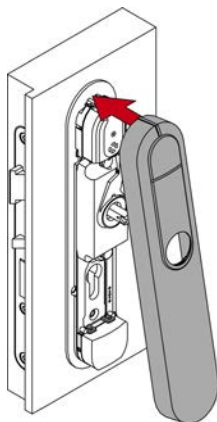

 45

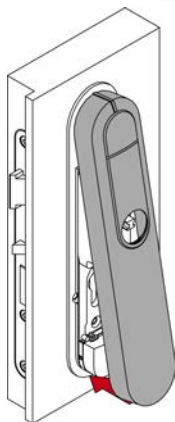

 46

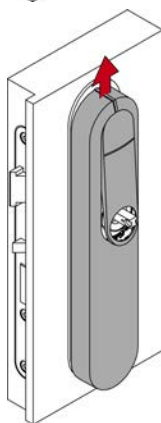

 47

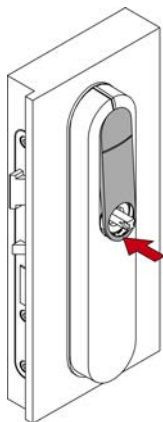

 48

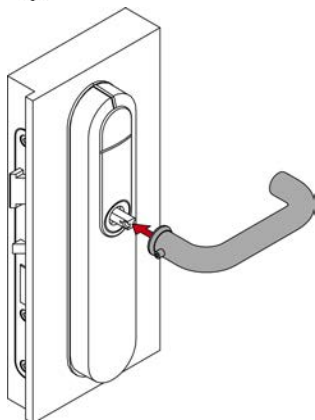

 49



TX15

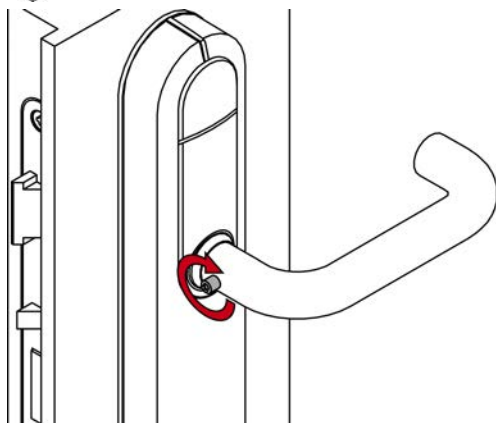

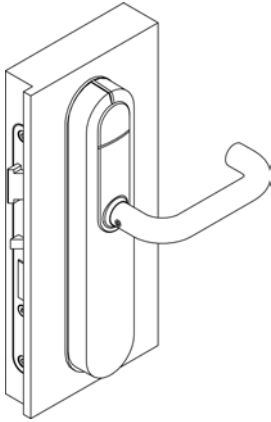

8. Removing the fitting (panic fitting)



SW1.5



SW1.5

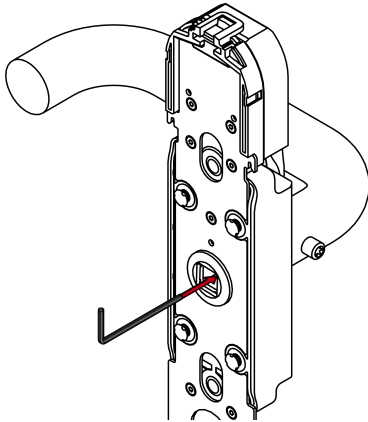

52



SW1.5

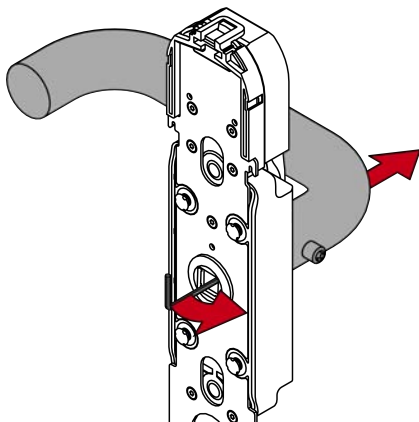

### 9. Replacing the batteries



53

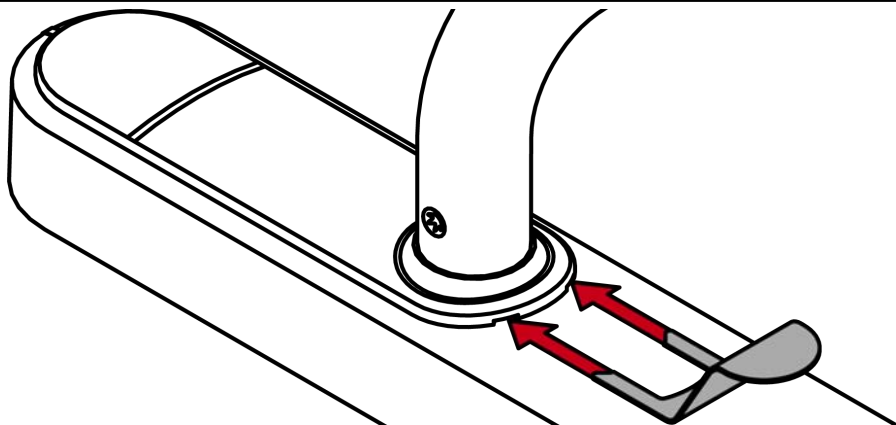

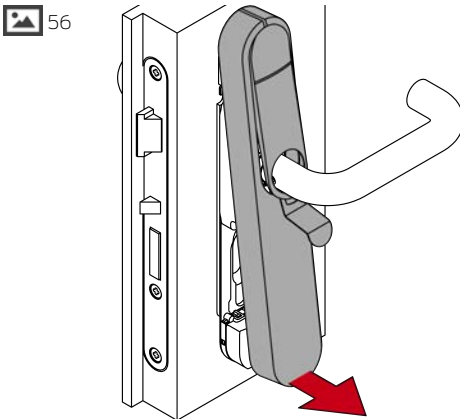
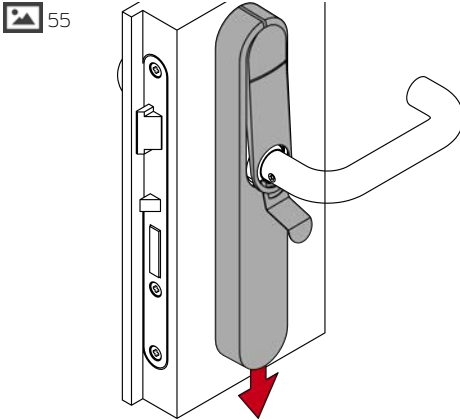
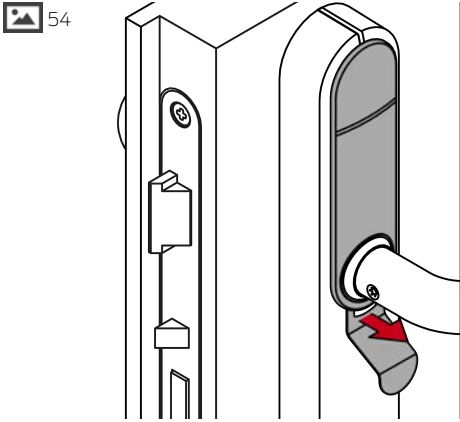

57

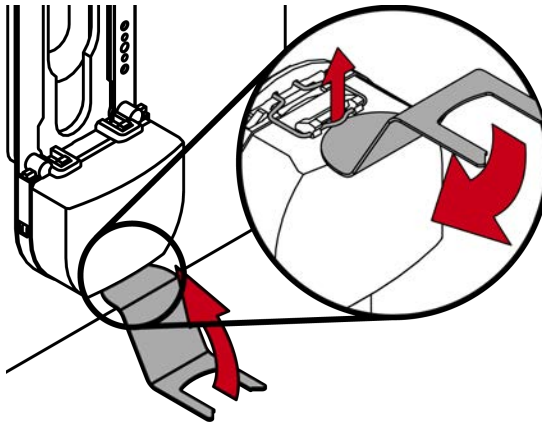

58

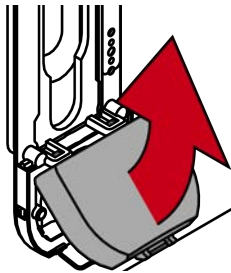

59

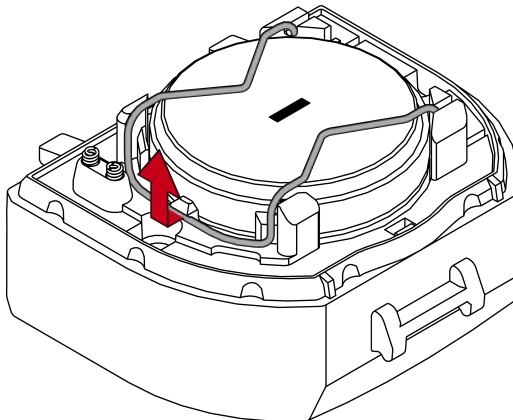

60

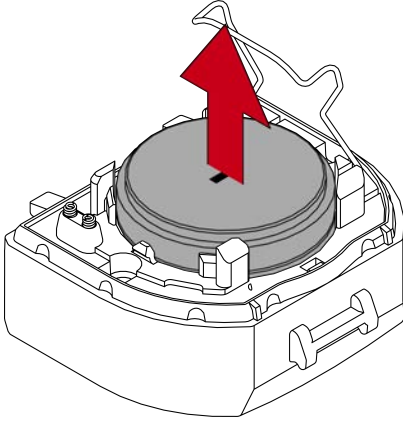

61

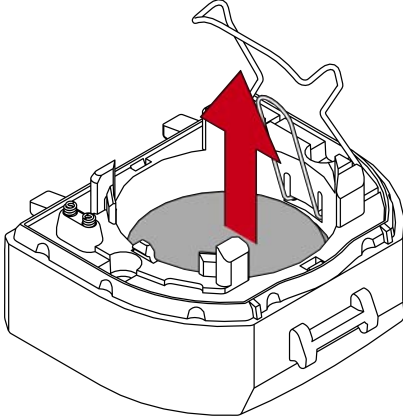

62

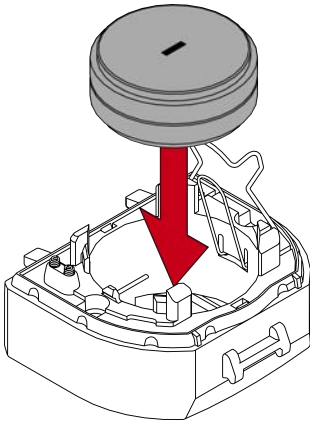



63

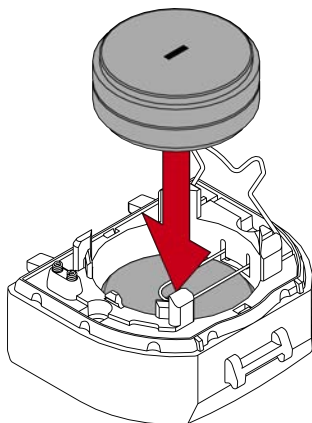

64

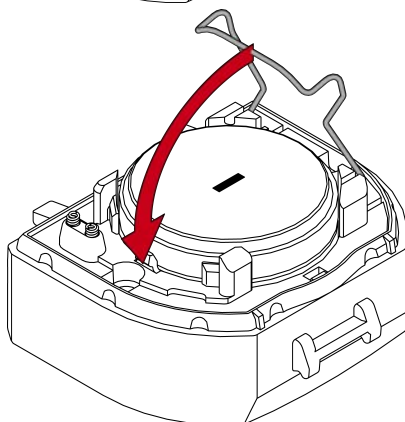

65

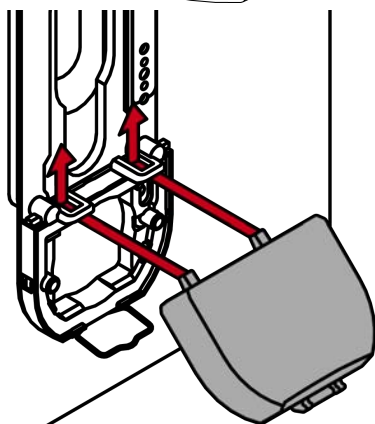

66

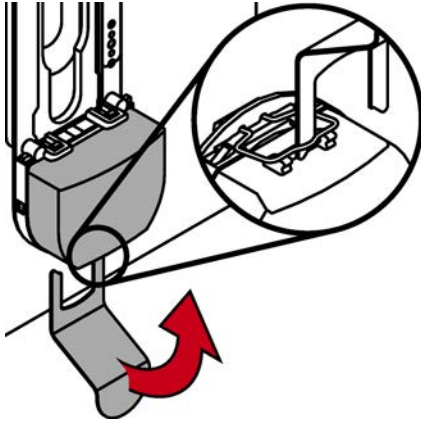

67

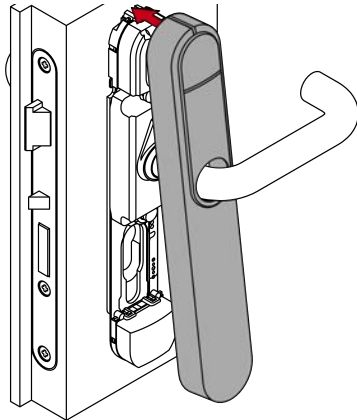

68

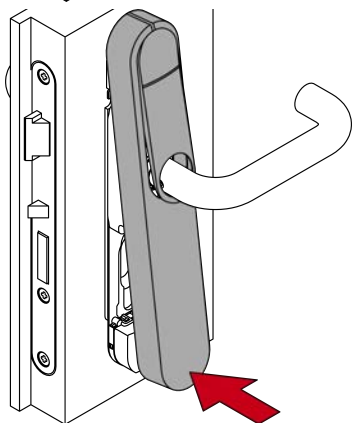

 69

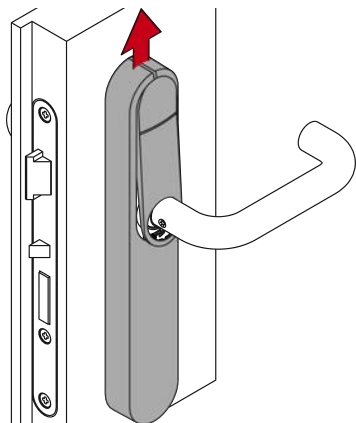

 70

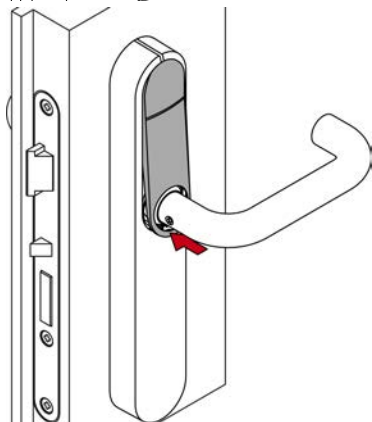

## 12. Help and other information

 71



## 1. Allgemeine Sicherheitshinweise

*Signalwort: Mögliche unmittelbare Auswirkungen bei Nichtbeachtung*

WARNUNG: Tod oder schwere Verletzung (möglich, aber unwahrscheinlich), VORSICHT: Leichte Verletzung, ACHTUNG: Sachschäden oder Fehlfunktionen, HINWEIS: Geringe oder keine



### WARNUNG

#### Versperrter Zugang

Durch fehlerhaft montierte und/oder programmierte Komponenten kann der Zutritt durch eine Tür versperrt bleiben. Für Folgen eines versperrten Zutritts wie Zugang zu verletzten oder gefährdeten Personen, Sachschäden oder anderen Schäden haftet die SimonsVoss Technologies GmbH nicht!

#### Versperrter Zugang durch Manipulation des Produkts

Wenn Sie das Produkt eigenmächtig verändern, dann können Fehlfunktionen auftreten und der Zugang durch eine Tür versperrt werden.

- ❖ Verändern Sie das Produkt nur bei Bedarf und nur in der Dokumentation beschriebenen Art und Weise.

#### Batterie nicht einnehmen. Verbrennungsgefahr durch gefährliche Stoffe

Dieses Produkt enthält Lithium-Knopfzellen. Wenn die Knopfzelle verschluckt wird, können schwere innere Verbrennungen innerhalb von gerade einmal zwei Stunden auftreten und zum Tode führen.

1. Halten Sie neue und gebrauchte Batterien von Kindern fern.
2. Wenn das Batteriefach nicht sicher schließt, dann benutzen Sie das Produkt nicht mehr und halten Sie es von Kindern fern.
3. Wenn Sie meinen, dass Batterien verschluckt wurden oder sich in irgendeinem Körperteil befinden, suchen Sie unverzüglich medizinische Hilfe auf.

#### Explosionsgefahr durch falschen Batterietyp

Das Einsetzen falscher Batterietypen kann zu einer Explosion führen.

- ❖ Verwenden Sie ausschließlich die in den technischen Daten spezifizierten Batterien.



### VORSICHT

#### Feuergefahr durch Batterien

Die eingesetzten Batterien können bei Fehlbehandlung eine Feuer- oder Verbrennungsgefahr darstellen.

1. Versuchen Sie nicht, die Batterien aufzuladen, zu öffnen, zu erhitzen oder zu verbrennen.
2. Schließen Sie die Batterien nicht kurz.

### ACHTUNG

#### Beschädigung durch elektrostatische Entladung (ESD) bei geöffnetem Gehäuse

Dieses Produkt enthält elektronische Bauteile, die durch elektrostatische Entladungen beschädigt werden können.

1. Verwenden Sie ESD-gerechte Arbeitsmaterialien (z.B. Erdungsarmband).
2. Erden Sie sich vor Arbeiten, bei denen Sie mit der Elektronik in Kontakt kommen könnten. Fassen Sie dazu geerdete metallische Oberflächen an (z.B. Türzargen, Wasserrohre oder Heizungsventile).

#### Beschädigung durch Öle, Fette, Farben und Säuren

Dieses Produkt enthält elektronische und/oder mechanische Bauteile, die durch Flüssigkeiten aller Art beschädigt werden können.

- ❖ Halten Sie Öle, Fette, Farben und Säuren vom Produkt fern.

#### Beschädigung durch aggressive Reinigungsmittel

Die Oberfläche dieses Produkts kann durch ungeeignete Reinigungsmittel beschädigt werden.

- ❖ Verwenden Sie ausschließlich Reinigungsmittel, die für Kunststoff- bzw. Metalloberflächen geeignet sind.

#### Beschädigung durch mechanische Einwirkung

Dieses Produkt enthält elektronische Bauteile, die durch mechanische Einwirkung aller Art beschädigt werden können.

1. Vermeiden Sie das Anfassen der Elektronik.
2. Vermeiden Sie sonstige mechanische Einwirkungen auf die Elektronik.

#### Beschädigung durch Verpolung

Dieses Produkt enthält elektronische Bauteile, die durch die Verpolung der Spannungsquelle beschädigt werden können.

- ❖ Verpolen Sie die Spannungsquelle nicht (Batterien bzw. Netzteile).

#### Störung des Betriebs durch Funkstörung

Dieses Produkt kann unter Umständen durch elektromagnetische oder magnetische Störungen beeinflusst werden.

- ❖ Montieren bzw. platzieren Sie das Produkt nicht unmittelbar neben Geräten, die elektromagnetische oder magnetische Störungen verursachen können (Schaltnetzteile!).

#### Störung der Kommunikation durch metallische Oberflächen

Dieses Produkt kommuniziert drahtlos. Metallische Oberflächen können die Reichweite des Produkts erheblich reduzieren.

- ❖ Montieren bzw. platzieren Sie das Produkt nicht auf oder in der Nähe von metallischen Oberflächen.



### HINWEIS

#### Bestimmungsgemäßer Gebrauch

SimonsVoss-Produkte sind ausschließlich für das Öffnen und Schließen von Türen und vergleichbaren Gegenständen bestimmt.

- ❖ Verwenden Sie SimonsVoss-Produkte nicht für andere Zwecke.

#### Funktionsstörungen durch schlechten Kontakt oder unterschiedliche Entladung

Zu kleine/verunreinigte Kontaktfächen oder unterschiedliche entladene Batterien können zu Funktionsstörungen führen.

1. Verwenden Sie nur Batterien, die von SimonsVoss freigegeben sind.
2. Berühren Sie die Kontakte der neuen Batterien nicht mit den Händen.
3. Verwenden Sie saubere und fettfreie Handschuhe.
4. Tauschen Sie immer alle Batterien gleichzeitig aus.

#### Abweichende Zeiten bei G2-Schließungen

Die interne Zeiteinheit der G2-Schließungen hat eine technisch bedingte Toleranz von bis zu  $\pm 15$  Minuten pro Jahr.

#### Qualifikationen erforderlich

Die Installation und Inbetriebnahme setzt Fachkenntnisse voraus.

- ❖ Nur geschultes Fachpersonal darf das Produkt installieren und in Betrieb nehmen.

Änderungen bzw. technische Weiterentwicklungen können nicht ausgeschlossen und ohne Ankündigung umgesetzt werden.

Die deutsche Sprachfassung ist die Originalbetriebsanleitung. Andere Sprachen (Abfassung in der Vertragssprache) sind Übersetzungen der Originalbetriebsanleitung.

Lesen Sie alle Anweisungen zur Installation, zum Einbau und zur Inbetriebnahme und befolgen Sie diese. Geben Sie diese Anweisungen und jegliche Anweisungen zur Wartung an den Benutzer weiter.

## 2. Produktspezifische Sicherheitshinweise

### ACHTUNG

#### Erschwerte Montage durch herausgedrückte Gewindehülsen

Die Gewindehülsen im Beschlag sind mit einer Presspassung montiert. Übermäßiges Drücken beim Festschrauben des Beschlags auf der Fixierplatte kann dazu führen, dass die Gewindehülsen aus dem Beschlag rutschen.

1. Drücken Sie beim Verschrauben des Modulträgers nicht auf die Schrauben.
2. Verwenden Sie einen Finger an den Enden Gewindehülsen, um während des Verschraubens gegenzuhalten.



### HINWEIS

#### Dokumentation des Panikstangen-Herstellers

In der Dokumentation des Panikstangen-Herstellers finden Sie weitere Informationen zu benötigten Teilen, Auflagen und Montagevorgaben.

- Lesen Sie auch diese Dokumentation, bevor Sie mit der Montage beginnen.

## 3. Lieferumfang

- SmartHandle AX Advanced Panikbeschlag mit breitem Schild
- Spezialwerkzeug
- Kurzanleitung

Nicht enthalten:

- Panikstange
- Schrauben zur Befestigung der Panikstange selbst

## 4. Aufbau mit Schild (\*PS\*)



## 5. Aufbau mit Rundrosette (\*PO\*)



## 6. Tür vorbereiten (Bohrschablone)

- ✓ Stift oder Anreißnadel vorhanden.
- ✓ Bohrmaschine vorhanden.
- ✓ Geeigneter Bohrer vorhanden ( $\varnothing$  7 mm, für Rundrosettenmontage zusätzlich  $\varnothing$  6 mm).
- ✓ PH2-Schraubendreher vorhanden.
- ✓ Lineal vorhanden.

1. Bauen Sie das Einsteckschloss aus.



2. Messen Sie die Distanz (Abstand der Drehachsen von Vierkant und Zylinder).



3. Bauen Sie das Einsteckschloss ein.



4. Stecken Sie den Vierkant in das Einsteckschloss.



5. Stecken Sie die Bohrschablone auf den Vierkant.



6. Richten Sie die Bohrschablone mithilfe der aufgedruckten Skala senkrecht aus.

7. Markieren Sie die zu bohrenden Punkte auf der Tür.



8. Entfernen Sie die Bohrschablone und den Vierkant.



9. Bauen Sie das Einsteckschloss aus.



10. Bohren Sie die benötigten Löcher.



11. Bauen Sie das Einsteckschloss ein.



## 7. Beschlag montieren

- ✓ Tür vorgebohrt.
- ✓ PH2-Schraubendreher vorhanden.
- ✓ TX15-Schraubendreher vorhanden.
- ✓ Messschieber vorhanden.
- ✓ Säge vorhanden.

1. Demontieren Sie die Panikstange wie in der Dokumentation des Herstellers bis auf die Aufnahmeplatte.
2. Messen Sie die Türdicke und bestimmen Sie die Länge des Vierkants.



*PS* (mit Schild)		*PO* (mit Rundrosette)	
BKS (Stangengriff)	Türdicke - 27,8 ± 1,5 mm	BKS (Druckstange)	Türdicke + 36,8 ± 2,5 mm
BKS (Druckstange)	Türdicke - 36,8 ± 2,5 mm		
CISA 8-mm-Vierkant	Türdicke - 27,3 ± 0,5 mm		
CISA 9-mm-Vierkant	Türdicke - 19,3 ± 0,5 mm		

3. Kürzen Sie mit einer geeigneten Säge den Vierkant.



4. Beziehen Sie die nicht im Lieferumfang enthaltenen Schrauben vom Hersteller Ihrer Panikstange.



### HINWEIS

#### Angaben des Panikstangen-Herstellers

Der Hersteller der Panikstange kann weitere Anforderungen an die Schrauben stellen, unter anderem zur Festigkeit und Länge.

- Beachten Sie die Dokumentation des Panikstangen-Herstellers.



























5. Setzen Sie die Hülsenmuttern und den Vierkantschutz in die Fixierplatte ein.





6. Setzen Sie den Abstandsring in die Öffnung auf die Hülsenmutter.



7. Stecken Sie den Modulträger in die Fixierplatte.  
 26
8. Schieben Sie den Modulträger nach oben.  
 27  
↳ Modulträger rastet ein.
9. Schrauben Sie mit den 16-mm-Schrauben den Modulträger an der Fixierplatte fest (PH2).  
 28  
 29
10. Stecken Sie den Vierkant in den Beschlag.  
 30
11. Stecken Sie den Modulträger mit der Fixierplatte in die Tür-Außenseite.  
 31
12. Für Nicht-MO: Setzen Sie den Blindzylinder ein.  
 32
13. Für Nicht-MO: Schrauben Sie den Blindzylinder fest.  
 33
14. Für PO (Rundrosette): Schrauben Sie die Rundrosetten-Basis fest (PH2).  
 34  
 35  
 36  
 37  
 38
15. Für PO (Rundrosette): Stecken Sie die Blende auf die Rundrosetten-Basis.  
 39
16. Schrauben Sie die Aufnahmeplatte der Panikstange fest (TX25).  
 40  
 41
17. Beachten Sie mögliche herstellerspezifische Vorgaben zur Befestigung der Aufnahmeplatte.  
 42
18. Befestigen Sie die Panikstange nach den Vorgaben des Herstellers (z.B. Madenschraube).  
 43
19. Setzen Sie das Cover oben auf der Fixierplatte an.  
 44
20. Klappen Sie das Cover nach unten zu.  
 45
21. Schieben Sie das Cover nach oben.  
 46
22. Drücken Sie das Inlay fest.  
 47
23. Stecken Sie den Außendrücker auf.  
 48
24. Schrauben Sie mit der Madenschraube den Außendrücker fest (TX15).  
 49  
↳ SmartHandle AX Advanced fertig montiert.  
 50

## 8. Beschlag demontieren (Panikbeschlag)

- ✓ 1,5-mm-Sechskantschlüssel vorhanden.

1. Demontieren Sie den Beschlag in umgekehrter Reihenfolge zur Montage.
2. Lösen Sie dabei das Cover, indem Sie mit dem Spezialwerkzeug das Inlay nach außen biegen.
3. Stecken Sie einen 1,5-mm-Sechskantschlüssel in das Loch der Vierkantaufnahme im Modulträger.  
 51
4. Biegen Sie den Sechskantschlüssel auf die Seite, auf der sich das Loch befindet und ziehen Sie gleichzeitig am Außendrücker.  
 52  
↳ SmartHandle AX Advanced ist demontiert.

## 9. Batterien wechseln















### HINWEIS

#### Funktionsstörungen durch schlechten Kontakt oder unterschiedliche Entladung

Zu kleine/verunreinigte Kontaktfächen oder unterschiedliche entladene Batterien können zu Funktionsstörungen führen.

1. Verwenden Sie nur Batterien, die von SimonsVoss freigegeben sind.
2. Berühren Sie die Kontakte der neuen Batterien nicht mit den Händen.
3. Verwenden Sie saubere und fettfreie Handschuhe.
4. Tauschen Sie immer alle Batterien gleichzeitig aus.

- ✓ Spezialwerkzeug vorhanden.
- ✓ Handschuhe vorhanden.

1. Stecken Sie das Spezialwerkzeug in das Cover-Inlay der Elektronikseite.  
 53
2. Biegen Sie mit dem Spezialwerkzeug das Cover-Inlay vorsichtig auf.  
 54
3. Schieben Sie das Cover nach unten.  
 55  
↳ Cover entriegelt.
4. Nehmen Sie das Cover ab.  
 56
5. Haken Sie mit dem Spezialwerkzeug die Klammer des Batteriemoduls aus.  
 57
6. Nehmen Sie das Batteriemodul ab.  
 58
7. Haken Sie mit dem Spezialwerkzeug die Batterie-Klammer aus.  
 59
8. Entnehmen Sie die oberen Batterien.  
 60
9. Biegen Sie die Zwischenfeder vorsichtig zur Seite.
10. Entnehmen Sie die unteren Batterien.  
 61
11. Setzen Sie zwei neue Batterien mit sich berührenden Pluspolen ein (Typ CR2450).  
 62  
↳ Zwischenfeder sichtbar oberhalb der unteren Batterien.
12. Setzen Sie zwei neue Batterien mit sich berührenden Pluspolen ein (Typ CR2450).  
 63
13. Haken Sie die Batterie-Klammer wieder ein.  
 64
14. Setzen Sie das Batteriemodul wieder in den Modulträger ein.  
 65

15. Haken Sie mit dem Spezialwerkzeug die Klammer des Batteriemoduls wieder ein.



66

- ↳ SmartHandle AX Advanced piept dreimal.

16. Setzen Sie das Cover oben auf der Fixierplatte an.



67

17. Klappen Sie das Cover nach unten zu.



68

18. Drücken Sie das Cover gegen die Tür und schieben Sie es gleichzeitig nach oben.



69

- ↳ Cover rastet ein.

19. Drücken Sie das Inlay fest.



70

- ↳ Batterien sind gewechselt.

## 10. Technische Daten

Temperaturbereich (Betrieb)	-25 °C bis +60 °C
Batterietyp	4 × CR2450 3V Lithium
Batteriehersteller	<ul style="list-style-type: none"> <li>■ Murata</li> <li>■ Panasonic</li> <li>■ Varta</li> </ul>
IP-Schutzklasse	Bis zu IP66 (WP-Variante)

### Funkemissionen

15,24 kHz - 72,03 kHz Nur für Artikelnummern: SV-S3.*AM.G2*, SV-S3.*A.G2*, SI-S3.*LN*	10 dBµA/m (3 m Entfernung)
13,560006 MHz - 13,560780 MHz Nur für Artikelnummern: SV-S3.*AM.G2*, SV-S3.*A.G2*, SI-S3.*M.WO*, SI-S3.*LN*	1,04 dBµA/m (3 m Entfernung)
868,000 MHz - 868,600 MHz / 869,700 MHz - 870,000 MHz Nur für Artikelnummern: SI-S3.*M.WO*, SI-S3.*LN*	<25 mW ERP
2402 MHz - 2480 MHz Nur für Artikelnummern: SV-S3.*AM.G2*, SV-S3.*A.G2*, SI-S3.*M.WO*, SI-S3.*LN*	2,5 mW

## 11. Konformitätserklärung

Hiermit erklärt die SimonsVoss Technologies GmbH, dass die Artikel (SI-S3.\*M.VCN\*, SV-S3.\*M.G2\*, SV-S3.\*AM.G2\*, SV-S3.\*A.G2\*, SI-S3.\*M.WO\*, SI-S3.\*LN\*) folgenden Richtlinien entsprechen:

- 2014/53/EU - Funkanlagen- bzw. für UK: Rechtsverordnung 2017 Nr. 1206 - Funkanlagen-
- 2011/65/EU -RoHS- bzw. für UK: Rechtsverordnung 2012 Nr. 3032 -RoHS-



Der vollständige Text der EU-Konformitätserklärung ist unter der folgenden Internetadresse verfügbar: [www.simons-voss.com/de/zertifikate.html](https://www.simons-voss.com/de/zertifikate.html).

Der vollständige Text der UK-Konformitätserklärung ist unter der folgenden Internetadresse verfügbar: [www.simons-voss.com/de/zertifikate.html](https://www.simons-voss.com/de/zertifikate.html).

## 12. Hilfe und weitere Informationen

### Infomaterial/Dokumente

<https://www.simons-voss.com/de/dokumente.html>

<https://www.smartintego.com/de/home/infocenter/dokumentation>

## Konformitätserklärungen und Zertifikate

<https://www.simons-voss.com/de/zertifikate.html>

### Informationen zur Entsorgung

- Entsorgen Sie das Gerät (SI-S3.\*M.VCN\*, SV-S3.\*M.G2\*, SV-S3.\*AM.G2\*, SV-S3.\*A.G2\*, SI-S3.\*M.WO\*, SI-S3.\*LN\*) nicht mit dem Hausmüll, sondern gemäß der europäischen Richtlinie 2012/19/EU bei einer kommunalen Sammelstelle für Elektro-Sonderabfälle.
- Recyceln Sie defekte oder verbrauchte Batterien gemäß der europäischen Richtlinie 2006/66/EG.
- Beachten Sie örtliche Bestimmungen zur getrennten Entsorgung von Batterien.
- Führen Sie die Verpackung einer umweltgerechten Wiederverwertung zu.



71

### Technischer Support

+49 (0) 89 / 99 228 333

### E-Mail

[support-simonsvoss@allegion.com](mailto:support-simonsvoss@allegion.com)

[si-support-simonsvoss@allegion.com](mailto:si-support-simonsvoss@allegion.com)

### FAQ

<https://faq.simons-voss.com/otrs/public.pl>

SimonsVoss Technologies GmbH, Feringastr. 4, D-85774 Unterföhring, Deutschland

## 1. General safety instructions

*Signal word: Possible immediate effects of non-compliance*

WARNING: Death or serious injury (possible, but unlikely), CAUTION: Minor injury, IMPORTANT: Property damage or malfunction, NOTE: Low or none



### WARNING

#### Blocked access

Access through a door may stay blocked due to incorrectly fitted and/or incorrectly programmed components. SimonsVoss Technologies GmbH is not liable for the consequences of blocked access such as access to injured or endangered persons, material damage or other damage!

#### Blocked access through manipulation of the product

If you change the product on your own, malfunctions can occur and access through a door can be blocked.

- Modify the product only when needed and only in the manner described in the documentation.

#### Do not swallow battery. Danger of burns from hazardous substances

This product contains lithium button cell batteries. Swallowing the button cell battery, in can result in severe internal burns leading to death in as little as two hours.

1. Keep new and used batteries away from children.
2. If the battery compartment does not close securely, cease using the product and keep it away from children.
3. If you think batteries have been swallowed or are in any part of the body, seek medical attention immediately.

#### Risk of explosion due to incorrect battery type

Inserting the wrong type of battery can cause an explosion.

- Only use the batteries specified in the technical data.



### CAUTION

#### Fire hazard posed by batteries

The batteries used may pose a fire or burn hazard if handled incorrectly.

1. Do not try to charge, open, heat or burn the batteries.
2. Do not short-circuit the batteries.

### IMPORTANT

#### Damage resulting from electrostatic discharge (ESD) when enclosure is open

This product contains electronic components that may be damaged by electrostatic discharges.

1. Use ESD-compliant working materials (e.g. Grounding strap).
2. Ground yourself before carrying out any work that could bring you into contact with the electronics. For this purpose, touch earthed metallic surfaces (e.g. door frames, water pipes or heating valves).

#### Damage resulting from liquids

This product contains electronic and/or mechanic components that may be damaged by liquids of any kind.

- Keep liquids away from the electronics.

#### Damage resulting from aggressive cleaning agents

The surface of this product may be damaged as a result of the use of unsuitable cleaning agents.

- Only use cleaning agents that are suitable for plastic or metal surfaces.

#### Damage as a result of mechanical impact

This product contains electronic components that may be damaged by mechanical impacts of any kind.

1. Avoid touching the electronics.
2. Avoid other mechanical influences on the electronics.

#### Damage due to polarity reversal

This product contains electronic components that may be damaged by reverse polarity of the power source.

- Do not reverse the polarity of the voltage source (batteries or mains adapters).

#### Operational malfunction due to radio interference

This product may be affected by electromagnetic or magnetic interference.

- Do not mount or place the product directly next to devices that could cause electromagnetic or magnetic interference (switching power supplies!).

#### Communication interference due to metallic surfaces

This product communicates wirelessly. Metallic surfaces can greatly reduce the range of the product.

- Do not mount or place the product on or near metallic surfaces.



### NOTE

#### Intended use

SimonsVoss-products are designed exclusively for opening and closing doors and similar objects.

- Do not use SimonsVoss products for any other purposes.

#### Malfunctions due to poor contact or different discharge

Contact surfaces that are too small/contaminated or different discharged batteries can lead to malfunctions.

1. Only use batteries that are approved by SimonsVoss.
2. Do not touch the contacts of the new batteries with your hands.
3. Use clean and grease-free gloves.
4. Always replace all batteries at the same time.

#### Different times for G2 locks

The internal time unit of the G2 locks has a technical tolerance of up to  $\pm 15$  minutes per year.

#### Qualifications required

The installation and commissioning requires specialized knowledge.

- Only trained personnel may install and commission the product.

Modifications or further technical developments cannot be excluded and may be implemented without notice.

The German language version is the original instruction manual. Other languages (drafting in the contract language) are translations of the original instructions.

Read and follow all installation, installation, and commissioning instructions. Pass these instructions and any maintenance instructions to the user.

## 2. Product-specific safety instructions

### IMPORTANT

#### Difficult installation due to threaded sleeves being pressed out

The threaded sleeves in the fitting are installed using a press fit. If you apply excessive pressure when screwing the fitting onto the fixing plate, this can lead to the threaded sleeves slipping out of the fitting.

1. Do not press on the screws when fastening the module support into place.
2. Place a finger on the ends of the threaded sleeves to hold them in place while screwing.



### NOTE

#### Panic bar manufacturer's documentation

You can find further information on the required parts, requirements and installation specifications in the panic bar manufacturer's documentation.

- Also read this documentation before commencing installation.



### 3. Scope of delivery

- SmartHandle AX Advanced Panic fitting with wide backplate
  - Special tool
  - Quick guide
- Not included:
- Panic bar
  - Screws for fastening the panic bar itself

### 4. Structure with backplate (\*PS\*)



### 5. Structure with round escutcheon (\*PO\*)



### 6. Prepare door (drilling template)

- ✓ Pin or scriber at hand.
- ✓ Drill at hand.
- ✓ Have suitable drill bit at hand ( $\varnothing$  7 mm; also  $\varnothing$  6 mm to install round escutcheon).
- ✓ PH2 screwdriver at hand.
- ✓ Ruler at hand.

1. Remove the mortise lock.



2. Measure the distance (gap between the spindle and cylinder axes of rotation).



3. Fit the mortise lock.



4. Insert the spindle into the mortise lock.



5. Place the drilling template on the spindle.



6. Align the drill template vertically using the printed scale.

7. Mark the points to be drilled on the door.



8. Remove the drilling template and spindle.



9. Remove the mortise lock.



10. Drill the required holes.



11. Fit the mortise lock.



### 7. Installing the fitting

- ✓ Door pre-drilled.
- ✓ PH2 screwdriver at hand.
- ✓ TX15 screwdriver at hand.
- ✓ Caliper gauge at hand.
- ✓ Saw at hand.

1. Remove the panic bar as described in the manufacturer's documentation except for the adapter plate.

2. Measure the door thickness and determine the length of the spindle.



*PS* (with backplate)		*PO* (with round escutcheon)	
BKS (bar handle)	Door thickness – 27.8 ± 1.5 mm	BKS (push bar)	Door thickness + 36.8 ± 2.5 mm
BKS (push bar)	Door thickness – 36.8 ± 2.5 mm		
CISA 8 mm spindle	Door thickness – 27.3 ± 0.5 mm		
CISA 9 mm spindle	Door thickness – 19.3 ± 0.5 mm		

3. Trim the spindle with a suitable saw.



4. Obtain the screws not included in the scope of delivery from the manufacturer of your panic bar.



#### NOTE

#### Panic bar manufacturer's specifications

The panic bar manufacturer may impose further requirements on the screws, including strength and length.

- Observe the documentation provided by the panic bar manufacturer.



5. Insert the sleeve nuts and spindle protection into the fixing plate.



6. Place the spacer ring in the opening of the sleeve nut.



7. Insert the module support into the fastening plate.



8. Slide the module support upwards.



- ↳ Module support snaps into place.

9. Fasten the module support to the fixing plate (PH2) with the 16 mm screws.



10. Insert the spindle into the fitting.



11. Insert the module support with the fastening plate into the outer side of the door.



12. For non-MO: insert the blank cylinder.



















13. For non-MO: screw the blank cylinder firmly into position.







14. For PO (round escutcheon): Fasten the round escutcheon base firmly (PH2).



-  35
-  36
-  37
-  38
- 15. For PO (round escutcheon): Place the cover on the round escutcheon base.
-  39
- 16. Fasten the panic bar mounting plate firmly (TX25).
-  40
-  41
- 17. Observe any manufacturer-specific requirements for attaching the mounting plate.
-  42
- 18. Fasten the panic bar according to the manufacturer's specifications (e.g. using grub screw).
-  43
- 19. Place the cover on top of the fastening plate.
-  44
- 20. Fold down the cover.
-  45
- 21. Slide the cover upwards.
-  46
- 22. Press the inlay into place.
-  47
- 23. Fit the outside handle.
-  48
- 24. Use the grub screw to fasten the outer handle (TX15) into position.
-  49
-  SmartHandle AX Advanced fully installed.
-  50

## 8. Removing the fitting (panic fitting)

-  1.5 mm hexagonal wrench available.
- 1. Remove the fitting in the reverse order to installation.
- 2. Loosen the cover by bending the inlay outwards using the special tool.
- 3. Insert a 1.5 mm hex key into the hole in the spindle mount in the module support.
-  51
- 4. Bend the hex key to the side where the hole is located while pulling on the outside handle.
-  52
-  SmartHandle AX Advanced is now removed.

## 9. Replacing the batteries



























### NOTE

#### Malfunctions due to poor contact or different discharge



Contact surfaces that are too small/contaminated or different discharged batteries can lead to malfunctions.

1. Only use batteries that are approved by SimonsVoss.
2. Do not touch the contacts of the new batteries with your hands.
3. Use clean and grease-free gloves.
4. Always replace all batteries at the same time.

-  Special tool at hand.

-  Gloves at hand.
- 1. Insert the special tool into the cover inlay on the electronics side.
-  53
- 2. Use the special tool to carefully bend the cover inlay upwards.
-  54
- 3. Slide the cover downwards.
-  55
-  Cover unlocked.
- 4. Remove the cover.
-  56
- 5. Use the special tool to detach the battery module clip.
-  57
- 6. Remove the battery module.
-  58
- 7. Use the special tool to detach the battery clip.
-  59
- 8. Remove the upper batteries.
-  60
- 9. Carefully bend the intermediate spring to one side.
- 10. Remove the lower batteries.
-  61
- 11. Insert two new batteries with the positive terminals next to each other (type CR2450).
-  62
-  Intermediate spring visible above the lower batteries.
- 12. Insert two new batteries with the positive terminals next to each other (type CR2450).
-  63
- 13. Reattach the battery clip.
-  64
- 14. Put the battery module back into the module support.
-  65
- 15. Use the special tool to reattach the battery module clip.
-  66
-  SmartHandle AX Advanced will beep three times.
- 16. Place the cover on top of the fastening plate.
-  67
- 17. Fold down the cover.
-  68
- 18. Push the cover against the door, sliding it upwards at the same time.
-  69
-  Cover snaps into place.
- 19. Press the inlay into place.
-  70
-  Batteries are now replaced.

## 10. Technical data

Operating temperature range	-25 °C to +60 °C
Battery type	4x CR2450 3V lithium
Battery manufacturer	<ul style="list-style-type: none"> <li> Murata</li> <li> Panasonic</li> <li> Varta</li> </ul>
IP protection rating	Up to IP66 (WP variant)

## Radio emissions

15.24 kHz - 72.03 kHz Only for item numbers: SV-S3.*AM.G2*, SV-S3.*A.G2*, SI-S3.*LN*	10 dBµA/m (3 m distance)
13.560006 MHz - 13.560780 MHz Only for item numbers: SV-S3.*AM.G2*, SV-S3.*A.G2*, SI-S3.*M.WO*, SI-S3.*LN*	1,04 dBµA/m (3 m distance)
868.000 MHz - 868.600 MHz / 869.700 MHz - 870.000 MHz Only for item numbers: SI-S3.*M.WO*, SI-S3.*LN*	<25 mW ERP
2402 MHz - 2480 MHz Only for item numbers: SV-S3.*AM.G2*, SV-S3.*A.G2*, SI-S3.*M.WO*, SI-S3.*LN*	2,5 mW

## 11. Declaration of conformity

The company SimonsVoss Technologies GmbH hereby declares that the articles (SI-S3.\*M.VCN\*, SV-S3.\*M.G2\*, SV-S3.\*AM.G2\*, SV-S3.\*A.G2\*, SI-S3.\*M.WO\*, SI-S3.\*LN\*) comply with the following guidelines:

- 2014/53/EU -RED-  
or for the UK: UK statutory 2017 No. 1206 -Radio equipment-
- 2011/65/EU -RoHS-  
or for the UK: UK statutory 2012 No. 3032 -RoHS-



The full text of the EU Declaration of conformity is available at the following internet address: [www.simons-voss.com/en/certificates.html](http://www.simons-voss.com/en/certificates.html).

The full text of the UK Declaration of conformity is available at the following internet address: [www.simons-voss.com/en/certificates.html](http://www.simons-voss.com/en/certificates.html).

## 12. Help and other information

### Information material/documents

<https://www.simons-voss.com/en/documents.html>

<https://www.smartintego.com/int/home/infocenter/documentation>

### Declarations of conformity

<https://www.simons-voss.com/en/certificates.html>

### Information on disposal

- Do not dispose the device (SI-S3.\*M.VCN\*, SV-S3.\*M.G2\*, SV-S3.\*AM.G2\*, SV-S3.\*A.G2\*, SI-S3.\*M.WO\*, SI-S3.\*LN\*) in the household waste. Dispose of it at a collection point for electronic waste as per European Directive 2012/19/EU.
- Recycle defective or used batteries in line with European Directive 2006/66/EC.
- Observe local regulations on separate disposal of batteries.
- Take the packaging to an environmentally responsible recycling point.



### Technical support

+49 (0) 89 / 99 228 333

### Email

[support-simonsvoss@allegion.com](mailto:support-simonsvoss@allegion.com)

[si-support-simonsvoss@allegion.com](mailto:si-support-simonsvoss@allegion.com)

### FAQs

<https://faq.simons-voss.com/otrs/public.pl>

SimonsVoss Technologies GmbH, Feringastr. 4, D-85774 Unterfoehring, Germany

## 1. Consignes de sécurité générales

*Mot indicateur: Effets immédiats possibles du non-respect*

AVERTISSEMENT: Mort ou blessure grave (possible, mais improbable), PRUDENCE: Blessure légère, ATTENTION: Dommages matériels ou dysfonctionnements, NOTE: Peu ou pas



### AVERTISSEMENT

#### Accès bloqué

Toute erreur de montage et/ou de programmation d'un composant peut bloquer l'accès par une porte. La société SimonsVoss Technologies GmbH décline toute responsabilité quant aux conséquences d'un accès bloqué, par exemple, accès pour les personnes blessées ou en danger, dommages matériels ou autres dommages !

#### Accès bloqué par la manipulation du produit

Si vous modifiez vous-même le produit, des dysfonctionnements peuvent se produire et l'accès peut être bloqué par une porte.

- Ne changer le produit que lorsque cela est nécessaire et de la manière décrite dans la documentation.

#### Ne pas saisir la pile. Risque de brûlures dues à des substances dangereuses

Ce produit contient des piles au lithium. En cas d'ingestion de la pile, de graves brûlures internes peuvent se produire sous deux heures et entraîner la mort.

1. Conservez les piles neuves et usagées hors de portée des enfants.
2. Si le compartiment à piles ne ferme pas correctement, cessez d'utiliser le produit et conservez-le hors de portée des enfants.
3. En cas de suspicion d'ingestion des piles ou si celles-ci se trouvent dans une partie quelconque de votre corps, consultez immédiatement un médecin.

#### Risque d'explosion dû à un type de batterie incorrect

L'insertion d'un mauvais type de batterie peut provoquer une explosion.

- Utilisez uniquement les piles indiquées dans les données techniques.



### PRUDENCE

#### Risque d'incendie dû aux piles

En cas de manipulation impropre, les piles insérées peuvent provoquer un incendie ou des brûlures.

1. Ne jamais essayer de recharger les piles, de les ouvrir, de les chauffer ou de les brûler.
2. Ne pas court-circuiter les piles.

### ATTENTION

#### Endommagement lié à une décharge électrostatique (DES) lorsque le boîtier est ouvert

Ce produit contient des composants électroniques susceptibles d'être endommagés par des décharges électrostatiques.

1. Utilisez du matériel de travail adapté à la DES (par ex. un bracelet de mise à la terre).
2. Reliez-vous à la terre avant de commencer les travaux pendant lesquels vous pouvez être en contact avec le système électronique. Saisissez pour cela des surfaces métalliques mises à la terre (par ex. huisseries de porte, conduites d'eau ou vannes de chauffage).

#### Endommagement lié à des liquides

Ce produit contient des composants électroniques et/ou mécaniques susceptibles d'être endommagés par tout type de liquide.

- Tenez les liquides à l'écart du système électronique.

#### Endommagement lié à des nettoyants agressifs

La surface de ce produit peut être endommagée par des nettoyants inappropriés.

- Utilisez exclusivement des nettoyants adaptés aux surfaces plastiques ou métalliques.

#### Endommagement lié à une action mécanique

Ce produit contient des composants électroniques susceptibles d'être endommagés par une action mécanique quelconque.

1. Évitez de toucher le système électronique.
2. Évitez toute autre action mécanique sur le système électronique.

#### Endommagement lié à une inversion de polarité

Ce produit contient des composants électroniques susceptibles d'être endommagés par une inversion de polarité de la source de tension.

- N'inversez pas la polarité de la source de tension (piles ou blocs d'alimentation).

#### Défaillance du fonctionnement liée à une perturbation radioélectrique

Dans certaines circonstances, ce produit peut subir l'influence de perturbations électromagnétiques ou magnétiques.

- Ne montez pas et ne placez pas le produit à proximité immédiate d'appareils pouvant générer des perturbations électromagnétiques ou magnétiques (alimentations à découpage !).

#### Défaillance de la communication liée à des surfaces métalliques

Ce produit communique sans fil. Les surfaces métalliques peuvent réduire considérablement le rayon d'action du produit.

- Ne montez pas et ne placez pas le produit sur ou à proximité de surfaces métalliques.



### NOTE

#### Utilisation conforme aux dispositions

Les produits SimonsVoss sont exclusivement destinés à l'ouverture et la fermeture de portes et d'objets similaires.

- N'utilisez pas les produits SimonsVoss à d'autres fins.

#### Horaires différents pour les fermetures G2

L'unité de temps interne des fermetures G2 présente une tolérance technique pouvant atteindre  $\pm 15$  minutes par an.

#### Qualifications requises

L'installation et la mise en service nécessitent des connaissances spécialisées.

- Seul le personnel qualifié peut installer et mettre en service le produit.

#### Dysfonctionnements dus à un mauvais contact ou à une décharge différée

Des surfaces de contact trop petites/contaminées ou différentes batteries déchargées peuvent entraîner des dysfonctionnements.

1. Utilisez uniquement des piles autorisées par la société SimonsVoss.
2. Ne touchez pas les contacts des piles neuves avec les mains.
3. Utilisez des gants propres et exempts de graisse.
4. Remplacez toujours toutes les piles à la fois.

Les modifications et nouveaux développements techniques ne peuvent pas être exclus et peuvent être mis en œuvre sans préavis.

La version allemande est le manuel d'instruction original. Les autres langues (rédaction dans la langue du contrat) sont des traductions des instructions originales.

Lisez et suivez toutes les instructions d'installation, d'installation et de mise en service. Transmettez ces instructions et toutes les instructions de maintenance à l'utilisateur.

## 2. Consignes de sécurité propres au produit

### ATTENTION

#### Montage difficile en raison de douilles filetées expulsées

Les douilles filetées dans la garniture sont montées avec un ajustement serré. Une pression excessive lors du vissage de la garniture sur la plaque de fixation peut entraîner le glissement des douilles filetées hors de la garniture.

1. N'appuyez pas sur les vis lors du vissage du support de module.
2. Utilisez un doigt aux extrémités des douilles filetées pour exercer une résistance pendant le serrage.



### NOTE

#### Documentation du fabricant de la barre anti-panique

Vous trouverez dans la documentation du fabricant de la barre anti-panique des informations complémentaires sur les pièces nécessaires, les conditions et les consignes de montage.

- Lisez également cette documentation avant de commencer l'installation.

## 3. Fourniture

- SmartHandle AX Advanced Barre anti-panique avec plaque large
- Outil spécial
- Guide abrégé

Non compris :

- Barre anti-panique
- Vis de fixation de la barre anti-panique

## 4. Montage avec plaque (\*PS\*)



## 5. Montage avec rosace ronde (\*PO\*)



## 6. Préparer la porte (gabarit de perçage)

- ✓ Goupille ou pointe disponible.
- ✓ Perceuse disponible.
- ✓ Foret approprié disponible (Ø 7 mm, pour le montage sur rosaces rondes Ø 6 mm supplémentaire).
- ✓ Tournevis PH2 disponible.
- ✓ Règle disponible.

1. Démontez la serrure encastrée.



2. Mesurez la distance (séparant les axes de rotation du carré et du cylindre).



3. Montez la serrure encastrée.



4. Insérez le carré dans la serrure encastrée.



5. Placez le gabarit de perçage sur le carré.



6. Orientez le gabarit de perçage à la verticale au moyen de la graduation imprimée.

7. Repérez sur la porte les points à percer.



8. Retirez le gabarit de perçage et le carré.



9. Démontez la serrure encastrée.



10. Percez les trous nécessaires.



11. Montez la serrure encastrée.



## 7. Monter la garniture

- ✓ Porte prépercée.
- ✓ Tournevis PH2 disponible.
- ✓ Tournevis TX15 disponible.
- ✓ Pied à coulisse disponible.
- ✓ Scie disponible.

1. Démontez la barre antipanique de la manière indiquée dans la documentation du fabricant à l'exception de la plaque de support.
2. Mesurez l'épaisseur de la porte et déterminez la longueur du carré.



*PS* (avec plaque)		*PO* (avec rosace ronde)	
BKS (Barre anti-panique)	Épaisseur de porte – 27,8 ± 1,5 mm	BKS (barre de pression)	Épaisseur de porte + 36,8 ± 2,5 mm
BKS (barre de pression)	Épaisseur de porte – 36,8 ± 2,5 mm		
Carré CISA 8 mm	Épaisseur de porte – 27,3 ± 0,5 mm		
Carré CISA 9 mm	Épaisseur de porte – 19,3 ± 0,5 mm		

3. Au moyen d'une scie adaptée, raccourcissez le carré.



4. Procurez-vous les vis non fournies auprès du fabricant de votre barre anti-panique.



### NOTE

#### Indications du fabricant de la barre anti-panique



























Le fabricant de la barre anti-panique peut imposer d'autres exigences aux vis, notamment en ce qui concerne la résistance et la longueur.

- Respectez la documentation du fabricant de la barre anti-panique.





5. Insérez les écrous à douille et la protection carrée dans la plaque de fixation.



6. Insérez la bague d'écartement dans son orifice des écrou à douille.
  -  24
  -  25
7. Insérez le support de module dans la plaque de fixation.
  -  26
8. Poussez le support de module vers le haut.
  -  27
  - ↳ Le support de module s'enclenche.
9. Vissez le support de module sur la plaque de fixation au moyen des vis de 16 mm (PH2).
  -  28
  -  29
10. Insérez le carré dans la garniture.
  -  30
11. Insérez le support de module avec la plaque de fixation, côté extérieur de la porte.
  -  31
12. En l'absence de surverrouillage mécanique : Insérez le cylindre aveugle.
  -  32
13. En l'absence de surverrouillage mécanique : Vissez le cylindre aveugle.
  -  33
14. Pour PO (rosace ronde) : vissez la base de la rosace ronde (PH2).
  -  34
  -  35
  -  36
  -  37
  -  38
15. Pour PO (rosace ronde) : emboîtez le cache sur la base de la rosace ronde.
  -  39
16. Vissez la plaque de montage de la barre anti-panique (TX25).
  -  40
  -  41
17. Respectez les éventuelles consignes spécifiques du fabricant pour la fixation de la plaque de montage.
  -  42
18. Fixez la barre anti-panique conformément aux instructions du fabricant (par ex. vis sans tête).
  -  43
19. Placez le capot en haut de la plaque de fixation.
  -  44
20. Rabattez le capot vers le bas.
  -  45
21. Poussez le capot vers le haut.
  -  46
22. Appuyez fermement sur l'incrustation.
  -  47
23. Mettez en place la poignée extérieure.
  -  48
24. Vissez la béquille extérieure à l'aide de la vis sans tête (TX15).
  -  49
- ↳ Le montage de la SmartHandle AX Advanced est terminé.
  -  50

## 8. Démonter la garniture (barre anti-panique)

- ✓ Clé à six pans 1,5 mm disponible.
1. Démontez la serrure en procédant comme pour le montage mais dans l'ordre inverse.
  2. Pour ce faire, désolidarisez le capot en pliant l'incrustation vers l'extérieur au moyen de l'outil spécial.
  3. Insérez une clé à six pans 1,5 mm dans le trou du logement du carré dans le support de module.
    -  51
  4. Pliez la clé à six pans du côté où se trouve le trou tout en tirant sur la poignée extérieure.
    -  52
  - ↳ La SmartHandle AX Advanced est démontée.

## 9. Remplacer les piles





















### NOTE

#### Dysfonctionnements dus à un mauvais contact ou à une décharge différentielle

Des surfaces de contact trop petites/contaminées ou différentes batteries déchargées peuvent entraîner des dysfonctionnements.

1. Utilisez uniquement des piles autorisées par la société SimonsVoss.
2. Ne touchez pas les contacts des piles neuves avec les mains.
3. Utilisez des gants propres et exempts de graisse.
4. Remplacez toujours toutes les piles à la fois.

- ✓ Outil spécial disponible.
  - ✓ Gants disponible.
1. Insérez l'outil spécial dans l'incrustation du capot du côté électronique.
    -  53
  2. Au moyen de l'outil spécial, pliez avec précaution l'incrustation du capot.
    -  54
  3. Poussez le capot vers le bas.
    -  55
    - ↳ Le capot se déverrouille.
  4. Retirez le capot.
    -  56
  5. Au moyen de l'outil spécial, décrochez les clips du module de batterie.
    -  57
  6. Retirez le module de piles.
    -  58
  7. Au moyen de l'outil spécial, décrochez les clips des piles.
    -  59
  8. Retirez les piles du haut.
    -  60
  9. Pliez avec précaution le ressort intermédiaire sur le côté.
    -  61
  10. Retirez les piles du bas.
    -  62
  11. Insérez deux nouvelles piles avec les pôles plus au contact l'un de l'autre (type CR2450).
    -  62
    - ↳ Ressort intermédiaire visible au-dessus des piles du bas.
  12. Insérez deux nouvelles piles avec les pôles plus au contact l'un de l'autre (type CR2450).
    -  63

13. Refermez les clips des piles.
  64
14. Réinsérez le module de piles dans le support de module.
  65
15. Au moyen de l'outil spécial, refermez les clips du module de batterie.
  66
  - ↳ La SmartHandle AX Advanced émet trois bips.
16. Placez le capot en haut de la plaque de fixation.
  67
17. Rabattez le capot vers le bas.
  68
18. Appuyez le capot contre la porte tout en le faisant glisser vers le haut.
  69
  - ↳ Le capot s'enclenche.
19. Appuyez fermement sur l'incrustation.
  70
  - ↳ Les piles sont changées.

## 10. Caractéristiques techniques

Plage de températures (fonctionnement)	de -25 °C à +60 °C
Type de piles	4 x piles CR2450 3V Lithium
Fabricant des piles	<ul style="list-style-type: none"> <li>■ Murata</li> <li>■ Panasonic</li> <li>■ Varta</li> </ul>
Classe de protection IP	Jusqu'à IP66 (version WP)

### Émissions de radio

15,24 kHz - 72,03 kHz Seulement pour les numéros d'article : SV-S3.*AM.G2*, SV-S3.*A.G2*, SI-S3.*LN*	10 dBµA/m (3 m distance)
13,560006 MHz - 13,560780 MHz Seulement pour les numéros d'article : SV-S3.*AM.G2*, SV-S3.*A.G2*, SI-S3.*M.WO*, SI-S3.*LN*	1,04 dBµA/m (3 m distance)
868,000 MHz - 868,600 MHz / 869,700 MHz - 870,000 MHz Seulement pour les numéros d'article : SI-S3.*M.WO*, SI-S3.*LN*	<25 mW ERP
2402 MHz - 2480 MHz Seulement pour les numéros d'article : SV-S3.*AM.G2*, SV-S3.*A.G2*, SI-S3.*M.WO*, SI-S3.*LN*	2,5 mW

## 11. Déclaration de conformité

La société SimonsVoss Technologies GmbH déclare par la présente que les articles (SI-S3.\*M.VCN\*, SV-S3.\*M.G2\*, SV-S3.\*AM.G2\*, SV-S3.\*A.G2\*, SI-S3.\*M.WO\*, SI-S3.\*LN\*) est conforme aux directives suivantes:

- 2014/53/EU -RED-  
ou pour UK : UK statutory 2017 No. 1206 -Radio equipment-  
(équipement radio)
- 2011/65/UE -RoHS-  
ou pour UK : UK statutory 2012 No. 3032 -RoHS-



Le texte intégral de la déclaration de conformité CE est disponible à l'adresse Internet suivante : [www.simons-voss.com/fr/certificats.html](http://www.simons-voss.com/fr/certificats.html).  
Le texte intégral de la déclaration de conformité UK est disponible à l'adresse Internet suivante : [www.simons-voss.com/fr/certificats.html](http://www.simons-voss.com/fr/certificats.html).

## 12. Aide et autres informations

### Documentation/documents

<https://www.simons-voss.com/fr/documents.html>

<https://www.smartintego.com/fr/home/infocenter/documentation>

### Déclarations de conformité

<https://www.simons-voss.com/fr/certificats.html>

### Informations sur l'élimination

- Ne jetez pas l'appareil (SI-S3.\*M.VCN\*, SV-S3.\*M.G2\*, SV-S3.\*AM.G2\*, SV-S3.\*A.G2\*, SI-S3.\*M.WO\*, SI-S3.\*LN\*) avec vos ordures ménagères mais dans un point de collecte communal pour appareils électriques et appareils spéciaux conformément à la directive européenne 2012/19/UE.
- Recyclez les piles défectueuses ou usées conformément à la directive européenne 2006/66/CE.
- Veuillez tenir compte des dispositions locales applicables concernant la collecte séparée des piles.
- Recyclez l'emballage d'une manière écologique.



### Assistance technique

+49 (0) 89 / 99 228 333

### E-Mail

[support-simonsvoss@allegion.com](mailto:support-simonsvoss@allegion.com)

[si-support-simonsvoss@allegion.com](mailto:si-support-simonsvoss@allegion.com)

### FAQ

<https://faq.simons-voss.com/otrs/public/>

SimonsVoss Technologies GmbH, Feringastr. 4, D-85774 Unterfoehring, Allemagne

## 1. Algemene veiligheidsinstructies

**Signaalwoord:** *Mogelijke onmiddellijke gevolgen van niet-naleving*  
**WAARSCHUWING:** Dood of ernstig letsel (mogelijk, maar onwaarschijnlijk).  
**VOORZICHTIG:** Lichte letsel, LET OP: Materiele schade of storing, OPMERKING: Laag of nee



### WAARSCHUWING

#### Geblokkeerde toegang

Door foutief geïnstalleerde en/of geprogrammeerde componenten kan de doorgang door een deur geblokkeerd blijven. Voor gevolgen van een geblokkeerde toegang tot gewonden of personen in gevaar, materiële of andere schade, is SimonsVoss Technologies GmbH niet aansprakelijk.

#### Geblokkeerde toegang als gevolg van manipulatie van het product

Als u het product zelf wijzigt, kunnen er storingen optreden en kan de toegang worden geblokkeerd door een deur.

- ▄ Vervang het product alleen wanneer dat nodig is en op de manier die in de documentatie wordt beschreven.

#### Batterijen niet inslikken. Verbrandingsgevaar door gevaarlijke stoffen

Dit product bevat lithium-knoopcellen. Als de knoopcel wordt ingeslikt, kunnen ernstige inwendige brandwonden optreden die binnen slechts twee uur de dood veroorzaken.

1. Houd nieuwe en gebruikte batterijen buiten bereik van kinderen.
2. Als het batterijvak niet goed sluit, mag u het product niet meer gebruiken en moet u het uit de buurt van kinderen houden.
3. Als u denkt dat batterijen zijn ingeslikt of in een ander lichaamsdeel terecht zijn gekomen, moet u onmiddellijk medische hulp inroepen.

#### Explosiegevaar door verkeerd type batterij

Het plaatsen van het verkeerde type batterij kan een explosie veroorzaken.

- ▄ Gebruik alleen de in de technische gegevens vermelde batterijen.



### VOORZICHTIG

#### Brandgevaar door batterijen

De gebruikte batterijen kunnen bij verkeerde behandeling tot brand- of verbrandingsgevaar leiden.

1. Probeer niet de batterijen op te laden, open te maken, te verwarmen of te verbranden.
2. U mag de batterijen evenmin kortsluiten.

### LET OP

#### Schade door elektrostatische ontlading (ESD) wanneer de behuizing open is

Dit product heeft elektronische componenten die kunnen worden beschadigd door een elektrostatische ontlading.

1. Maak gebruik van ESD-conforme materialen (bijv. aardingsarmband).
2. Zorg dat u geaard bent voor werkzaamheden waarbij u met de elektronica in contact kunt komen. Gebruik hiervoor geaarde metalen oppervlakken (bijv. Deurposten, waterleidingen of verwarmingsbuizen).

#### Beschadiging door vloeistoffen

Dit product heeft elektronische en/of mechanische componenten die kunnen worden beschadigd door elk type vloeistof.

- ▄ Houd vloeistoffen uit de buurt van de elektronica.

#### Beschadiging door bijtende reinigingsmiddelen

Het oppervlak van dit product kan worden beschadigd door ongeschikte reinigingsmiddelen.

- ▄ Maak uitsluitend gebruik van reinigingsmiddelen die geschikt zijn voor kunststof of metalen oppervlakken.

#### Beschadiging door mechanische impact

Dit product heeft elektronische componenten die kunnen worden beschadigd door elk type mechanische impact.

1. Vermijd dat u de elektronica aanraakt.
2. Vermijd ook andere mechanische impact op de elektronica.

#### Beschadiging door verwisseling van de polariteit

Dit product bevat elektronische componenten die door verwisseling van de polariteit van de voedingsbron beschadigd kunnen worden.

- ▄ Vervissel de polariteit van de voedingsbron niet (batterijen of netadapters).

#### Storing van het gebruik door verbroken verbinding

Dit product kan onder bepaalde omstandigheden beïnvloed worden door elektromagnetische of magnetische storingen.

- ▄ Monteer of plaats het product niet direct in de buurt van apparaten die elektromagnetische of magnetische storingen kunnen veroorzaken (stroomschakelaars!).

#### Storing van de communicatie door metalen oppervlakken

Dit product communiceert draadloos. Metalen oppervlakken kunnen het zendbereik van het product aanzienlijk verminderen.

- ▄ Monteer of plaats het product niet op of in de buurt van metalen oppervlakken.



### OPMERKING

#### Beoogd gebruik

SimonsVoss-producten zijn uitsluitend bedoeld voor het openen en sluiten van deuren en vergelijkbare voorwerpen.

- ▄ Gebruik SimonsVoss-producten niet voor andere doeleinden.

#### Storingen door slecht contact of verschillende ontladingen

Contactoppervlakken die te klein/vervuld zijn of verschillende ontladen accus' kunnen leiden tot storingen.

1. Gebruik alleen batterijen die zijn vrijgegeven door SimonsVoss.
2. Raak de contacten van de nieuwe batterijen niet met de handen aan.
3. Gebruik schone, vetvrije handschoenen.
4. Vervang daarom alle batterijen tegelijk.

#### Afwijkende tijden bij G2-sluitelementen

De interne tijdeenheid van de G2-sluitelementen heeft een technisch bepaalde tolerantie van max. ± 15 minuten per jaar.

#### Kwalificaties vereist

De installatie en inbedrijfstelling vereist gespecialiseerde kennis. Alleen getraind personeel mag het product installeren en in bedrijf stellen.

Aanpassingen of nieuwe technische ontwikkelingen kunnen niet uitgesloten worden en worden gerealiseerd zonder aankondiging.

De Duitse taalversie is de originele handleiding. Andere talen (opstellen in de contracttaal) zijn vertalingen van de originele instructies.

Lees en volg alle installatie-, installatie- en inbedrijfstellingsinstructies. Geef deze instructies en eventuele onderhoudsinstructies door aan de gebruiker.

## 2. Specifieke veiligheidsinstructies per product

### LET OP

#### Moelijke montage door naar buiten gedrukte schroefdraadhuizen

De schroefdraadhuizen in het beslag zijn met een perspassing gemonteerd. Overmatige druk bij het vastschroeven van het beslag op de bevestigingsplaat kan ertoe leiden dat de schroefdraadhuizen uit het beslag glijden.

1. Druk bij het vastschroeven van de moduledrager niet op de schroeven.
2. Houd de uiteinden van de schroefdraadhuizen met een vinger tegen tijdens het vastschroeven.





**OPMERKING**

**Documentatie van de fabrikant van de paniekstang**

In de documentatie van de fabrikant van de paniekstang vindt u meer informatie over de benodigde onderdelen, voorwaarden en montagevoorschriften.

- Lees ook deze documentatie voordat u met de montage begint.

### 3. Leveromvang

- SmartHandle AX Advanced Paniekbeslag met breed schild
- Speciaal gereedschap
- Korte handleiding

Niet inbegrepen:

- paniekstang
- schroeven voor de bevestiging van de paniekstang zelf

### 4. Opbouw met schild (\*PS\*)



### 5. Opbouw met ronde rozet (\*PO\*)



### 6. Deur voorbereiden (boormal)

- ✓ Pen of kraspen beschikbaar.
- ✓ een boormachine beschikbaar houden.
- ✓ Geschikte boor aanwezig (Ø 7 mm, voor montage ronde rozet extra Ø 6 mm).
- ✓ PH2-schroevendraaier beschikbaar.
- ✓ Heerser beschikbaar.

1. Demonteer het insteekslot.



2. Meet de afstand (van de draaiassen van vierkant en cilinder).



3. Bouw het insteekslot in.



4. Steek het vierkant in het insteekslot.



5. Plaats de boormal op het vierkant.



6. Lijn de boormal verticaal uit met behulp van de opgedrukte schaalverdeling.

7. Markeer de punten die geboord moeten worden op de deur.



8. Neem de boormal en het vierkant weg.



9. Demonteer het insteekslot.



10. Boor de benodigde gaten.



11. Bouw het insteekslot in.



## 7. Beslag monteren

- ✓ Deur voorgeboord.
- ✓ PH2-schroevendraaier beschikbaar.
- ✓ TX15-schroevendraaier beschikbaar.
- ✓ Remklauwmeter beschikbaar.
- ✓ Saw beschikbaar.

1. Demonteer de paniekstang volgens de documentatie van de fabrikant tot op de steunplaat.
2. Meet de deurdikte en bepaal de lengte van de vierkantstift.



*PS* (met schild)		*PO* (met ronde rozet)	
BKS (stang-greep)	Deurdikte – 27,8 ± 1,5 mm	BKS (drukstang)	Deurdikte + 36,8 mm ± 2,5 mm
BKS (drukstang)	Deurdikte – 36,8 ± 2,5 mm		
CISA 8 mm-vierkantstift	Deurdikte – 27,3 ± 0,5 mm		
CISA 9 mm-vierkantstift	Deurdikte – 19,3 ± 0,5 mm		

3. kort de vierkantstift in met een geschikte zaag.



4. Bestel de niet meegeleverde schroeven bij de fabrikant van uw paniekstang.



**OPMERKING**

**Informatie van de fabrikant van de paniekstang**

De fabrikant van de paniekstang kan andere eisen stellen aan de schroeven, onder andere met betrekking tot sterkte en lengte.

- Raadpleeg de documentatie van de fabrikant van de paniekstang.



5. Breng de busmoeren en de bescherming van de vierkantstift aan in de bevestigingsplaat.



6. Plaats de afstandsring in de opening op de hulsmoer.



7. Steek de moduledrager in de bevestigingsplaat.



8. Schuif de moduledrager omhoog.















- ↳ De moduledrager klikt vast.

9. Schroef de moduledrager met de schroeven van 12 mm vast op de bevestigingsplaat (PH2).



10. Steek de vierkantstift in het beslag.



11. Steek de moduledrager met de bevestigingsplaat in de buitenkant van de deur.
  31
  12. Voor niet-MO: breng de blinde cilinder aan.
  32
  13. Voor niet-MO: schroef de blinde cilinder vast.
  33
  14. Voor PO (ronde rozet): schroef de basis van de ronde rozet vast (PH2).
  34
  35
  36
  37
  38
  15. Voor PO (ronde rozet): steek de deklijst op de basis van de ronde rozet.
  39
  16. Schroef de montageplaat van de paniekstang vast (TX25).
  40
  41
  17. Neem eventuele specifieke voorschriften van de fabrikant voor de bevestiging van de montageplaat in acht.
  42
  18. Bevestig de paniekstang volgens de instructies van de fabrikant (bijv. stifttap).
  43
  19. zet de cover bovenop de bevestigingsplaat.
  44
  20. Klap de cover naar beneden dicht.
  45
  21. Schuif de cover omhoog.
  46
  22. Druk de inlay vast.
  47
  23. Steek de buitendeurkruk erop.
  48
  24. Schroef de buitendeurkruk vast met de stifttap (TX15).
  49
- ↳ SmartHandle AX Advanced montage afgerond.
- 
- 50

## 8. Beslag demonteren (paniekbeslag)

- ✓ 1,5 mm inbussleutel beschikbaar.
1. Demonteer het beslag in omgekeerde volgorde van de montage.
  2. Maak daarbij de cover los door met het speciale gereedschap de inlay naar buiten te buigen.
  3. Steek een inbussleutel van 1,5 mm in het gat van de opname voor de vierkantstift in de moduledrager.
  51
  4. Buig de inbussleutel naar de zijde waar het gat zich bevindt en trek tegelijkertijd aan de buitendeurkruk.
  52
- ↳ SmartHandle AX Advanced is gemonteerd.

## 9. Batterijen vervangen

















### OPMERKING

#### Storingen door slecht contact of verschillende ontladingen

Contactoppervlakken die te klein/vervuld zijn of verschillende ontladen accu's kunnen leiden tot storingen.

1. Gebruik alleen batterijen die zijn vrijgegeven door SimonsVoss.
2. Raak de contacten van de nieuwe batterijen niet met de handen aan.
3. Gebruik schone, vetvrije handschoenen.
4. Vervang daarom alle batterijen tegelijk.

- ✓ Speciaal gereedschap beschikbaar.
  - ✓ Handschoenen beschikbaar.
1. Steek het speciale gereedschap in de cover-inlay aan de elektronicazijde.
  53
  2. Buig de coverinlay behoedzaam open met het speciale gereedschap.
  54
  3. Schuif de cover naar beneden.
  55
    - ↳ Cover ontgrendeld.
  4. Neem de cover weg.
  56
  5. Haak met het speciale gereedschap de klem van de batterijmodule los.
  57
  6. Neem de batterijmodule weg.
  58
  7. Maak de batterijklem los met het speciale gereedschap.
  59
  8. Neem de bovenste batterijen uit.
  60
  9. Buig de tussenveer behoedzaam opzij.
  61
  10. Neem nu de onderste batterijen uit.
  62
    - ↳ De tussenveer is zichtbaar boven de onderste batterijen.
  12. Zet twee nieuwe batterijen in met de pluspolen tegen elkaar (type CR2450).
  63
  13. Haak de batterijklem weer vast.
  64
  14. Breng de batterijmodule weer aan in de moduledrager.
  65
  15. Haak met het speciale gereedschap de klem van de batterijmodule weer vast.
  66
    - ↳ SmartHandle AX Advanced piept drie keer.
  16. zet de cover bovenop de bevestigingsplaat.
  67
  17. Klap de cover naar beneden dicht.
  68
  18. Duw de cover tegen de deur en schuif hem tegelijkertijd omhoog.
  69
    - ↳ De cover klikt vast.

19. Druk de inlay vast.



- ↳ De batterijen zijn vervangen.

## 10. Technische gegevens

Temperatuurbereik (bedrijf)	-25°C tot +60°C
Soort batterij	4x CR2450 3V lithium
Batterijmerk	<ul style="list-style-type: none"> <li>■ Murata</li> <li>■ Panasonic</li> <li>■ Varta</li> </ul>
IP-beschermingsklasse	Tot IP66 (WP-variant)

### Radio-emissies

15,24 kHz - 72,03 kHz Alleen voor artikelnummers: SV-S3.*AM.G2*, SV-S3.*A.G2*, SI-S3.*LN*	10 dBµA/m (3 m afstand)
13,560006 MHz - 13,560780 MHz Alleen voor artikelnummers: SV-S3.*AM.G2*, SV-S3.*A.G2*, SI-S3.*M.WO*, SI-S3.*LN*	1,04 dBµA/m (3 m afstand)
868,000 MHz - 868,600 MHz / 869,700 MHz - 870,000 MHz Alleen voor artikelnummers: SI-S3.*M.WO*, SI-S3.*LN*	<25 mW ERP
2402 MHz - 2480 MHz Alleen voor artikelnummers: SV-S3.*AM.G2*, SV-S3.*A.G2*, SI-S3.*M.WO*, SI-S3.*LN*	2,5 mW

## 11. Verklaring van overeenstemming

Het bedrijf SimonsVoss Technologies GmbH verklaart dat de artikelen (SI-S3.\*M.VCN\*, SV-S3.\*M.G2\*, SV-S3.\*AM.G2\*, SV-S3.\*A.G2\*, SI-S3.\*M.WO\*, SI-S3.\*LN\*) voldoen aan de volgende richtlijnen:

- 2014/53/EU -RED- of voor de UK: UK wettelijk 2017 Nr. 1206 -Radioapparatuur-
- 2011/65/EU -RoHS- of voor de UK: UK wettelijk 2012 Nr. 3032 -RoHS-



De volledige tekst van de EU-conformiteitsverklaring is beschikbaar op het volgende internetadres: [www.simons-voss.com/nl/certificaten.html](http://www.simons-voss.com/nl/certificaten.html).

De volledige tekst van de UK-conformiteitsverklaring is beschikbaar op het volgende internetadres: [www.simons-voss.com/nl/certificaten.html](http://www.simons-voss.com/nl/certificaten.html).

## 12. Hulp en verdere informatie

### Informatiemateriaal/documenten

<https://www.simons-voss.com/nl/documenten.html>

<https://www.smartintego.com/int/home/infocenter/documentation>

### Conformiteitsverklaringen

<https://www.simons-voss.com/nl/certificaten.html>

### Informatie over verwijdering

- Voer het apparaat (SI-S3.\*M.VCN\*, SV-S3.\*M.G2\*, SV-S3.\*AM.G2\*, SV-S3.\*A.G2\*, SI-S3.\*M.WO\*, SI-S3.\*LN\*) niet af als huishoudelijk afval, maar overeenkomstig de Europese Richtlijn 2012/19/EU bij een gemeentelijke inzamelingspunt voor speciaal elektrotechnisch afval.
- Zorg voor recycling van defecte of gebruikte batterijen volgens de Europese Richtlijn 2006/66/EG.
- Neem de plaatselijke bepalingen in acht voor de gescheiden afvoer van batterijen.
- Voer de verpakking af naar een instantie voor milieuvriendelijke recycling.



### Technische Support

+49 (0) 89 / 99 228 333

### E-mail

[support-simonsvoss@allegion.com](mailto:support-simonsvoss@allegion.com)

[si-support-simonsvoss@allegion.com](mailto:si-support-simonsvoss@allegion.com)

### FAQ

<https://faq.simons-voss.com/otrs/public.pl>

SimonsVoss Technologies GmbH, Feringastr. 4, 85774 Unterföhring, Duitsland

## 1. Avvisi di sicurezza generali

*Parola segnale: Possibili effetti immediati di non conformità*

**AVVERTENZA:** Morte o lesioni gravi (possibili, ma improbabili), **ATTENZIONE:** Lesione minori, **AVVISO:** Danni materiali o malfunzionamento, **NOTA:** Basso o no



### AVVERTENZA

#### Accesso bloccato

Con componenti montati e/o programmati in modo difettoso, l'accesso attraverso una porta può restare bloccato. La SimonsVoss Technologies GmbH non risponde delle conseguenze di un accesso bloccato, per esempio nel caso si debba accedere a persone ferite o in pericolo, di danni a cose o altri danni!

#### Accesso bloccato tramite manipolazione del prodotto

Se si modifica il prodotto da solo, possono verificarsi malfunzionamenti e l'accesso attraverso una porta può essere bloccato.

- Modificare il prodotto solo quando necessario e solo nel modo descritto nella documentazione.

#### Non ingerire la batteria. Pericolo di ustioni dovute a sostanze pericolose

Questo prodotto contiene batterie a bottone al litio. Se la batteria a bottone viene inghiottita, possono verificarsi gravi ustioni interne nel giro di sole due ore che possono causare la morte.

1. Conservare le batterie nuove e usate lontano dalla portata dei bambini.
2. Se il vano batteria non si chiude in modo sicuro, interrompere l'uso del prodotto e tenerlo lontano dalla portata dei bambini.
3. Se pensate che le batterie siano state inghiottite o si trovino in una qualsiasi parte del vostro corpo, rivolgetevi immediatamente a un medico.

#### Pericolo di esplosione a causa di un tipo di batteria non corretto

L'inserimento del tipo di batteria sbagliato può causare un'esplosione.

- Utilizzare solo le batterie specificate nei dati tecnici.



### ATTENZIONE

#### Pericolo di incendio dovuto alle batterie

Le batterie utilizzate possono costituire un pericolo di incendio o combustione in caso di utilizzo scorretto.

1. Non tentare di caricare, aprire, riscaldare o bruciare le batterie.
2. Non cortocircuitare le batterie.

### AVVISO

#### Danni dovuti a scariche elettrostatiche (ESD) quando l'alloggiamento è aperto

Il presente prodotto contiene componenti elettronici che potrebbero subire danni in conseguenza di scariche elettrostatiche.

1. Utilizzare materiali di lavori conformi ai requisiti ESD (ad es. fascetta antistatica al polso).
2. Effettuare la messa a terra dell'operatore prima di eseguire lavori in cui è possibile entrare in contatto con parti elettroniche. A tale scopo, toccare una superficie metallica opportunamente messa a terra (ad es. telaio porta, tubi dell'acqua o valvole di riscaldamento).

#### Danni dovuti a fluidi

Il presente prodotto contiene componenti elettronici e/o meccanici che potrebbero subire danni dovuti a liquidi di qualunque tipo.

- Tenere i componenti elettronici lontani da liquidi.

#### Danni dovuti a detergenti aggressivi

La superficie di questo prodotto può essere danneggiata da detergenti non idonei.

- Utilizzare esclusivamente detergenti adatti a superfici in plastica o metallo.

#### Danni dovuti a effetti meccanici

Il presente prodotto contiene componenti elettronici che potrebbero subire danni dovuti a effetti meccanici di qualunque tipo.

1. Evitare di toccare le parti elettroniche.
2. Evitare ulteriori effetti meccanici sulle parti elettroniche.

#### Danni dovuti all'inversione di polarità

Questo prodotto contiene componenti elettronici che possono essere danneggiati dall'inversione di polarità della sorgente di tensione.

- Non invertire la polarità della sorgente di tensione (batterie o alimentatori).

#### Funzionamento disturbato a causa di interferenze radioelettriche

Questo prodotto potrebbe essere influenzato da disturbi elettromagnetici o magnetici.

- Non montare o posizionare il prodotto direttamente accanto a dispositivi che possono causare interferenze elettromagnetiche o magnetiche (alimentatori switching!).

#### Interferenze nella comunicazione dovute a superfici metalliche

Questo prodotto comunica in modalità wireless. Le superfici metalliche possono ridurre significativamente la portata del prodotto.

- Non montare o posizionare il prodotto sopra o vicino a superfici metalliche.



### NOTA

#### Uso conforme

I prodotti SimonsVoss sono concepiti esclusivamente per l'apertura e la chiusura di porte e oggetti simili.

- Non utilizzare i prodotti SimonsVoss per altri scopi.

#### Malfunzionamenti dovuti a contatto insufficiente o a scarichi diversi

Superfici di contatto troppo piccole/contaminate o diverse batterie scariche possono portare a malfunzionamenti.

1. Utilizzare esclusivamente batterie autorizzate da SimonsVoss.
2. Non toccare con le mani i contatti delle nuove batterie.
3. Utilizzare guanti puliti e privi di grasso.
4. Sostituire sempre tutte le batterie contemporaneamente.

#### Tempi diversi per chiusure G2

L'unità temporale interna delle chiusure G2 è tecnicamente vincolata a una tolleranza fino a  $\pm 15$  minuti all'anno.

#### Qualifiche richieste

L'installazione e la messa in servizio richiedono conoscenze specialistiche.

- Solo personale qualificato può installare e mettere in servizio il prodotto.

Non si escludono modifiche o perfezionamenti tecnici, anche senza preavviso.

La versione in lingua tedesca è il manuale di istruzioni originale. Altre lingue (redazione nella lingua del contratto) sono traduzioni delle istruzioni originali.

Leggere e seguire tutte le istruzioni di installazione, installazione e messa in servizio. Passare queste istruzioni e tutte le istruzioni di manutenzione all'utente.

## 2. Avvertenze di sicurezza specifiche del prodotto

### AVVISO

#### Montaggio difficoltoso a causa di manicotti filettati spinti fuori.

I manicotti filettati sono montati a pressione nella maniglia. La pressione eccessiva durante l'avvitatura a stringere della maniglia sulla piastra di fissaggio può provocare la fuoriuscita dei manicotti filettati dalla maniglia.

1. Non esercitare pressione sulle viti durante l'avvitamento del supporto del modulo.
2. Tenere un dito alle estremità dei manicotti filettati, in modo da opporre resistenza durante l'avvitamento.



### NOTA

#### Documentazione del fabbricante del maniglione antipanico

Nella documentazione del fabbricante del maniglione antipanico sono disponibili ulteriori informazioni su parti necessarie, condizioni e regole di montaggio.

- Leggere anche la suddetta documentazione prima di iniziare il montaggio.

## 3. Oggetto di fornitura

- SmartHandle AX Advanced Maniglione antipanico con coprimaniglia largo

- Attrezzo speciale

- Libretto di istruzioni

Non inclusi:

- Maniglione antipanico

- Viti per il fissaggio dello stesso maniglione antipanico

## 4. Struttura con coprimaniglia (\*PS\*)



## 5. Struttura con rosetta tonda (\*PO\*)



## 6. Preparazione della porta (maschera di foratura)

- ✓ Perno o punta per tracciare a disposizione.
- ✓ Trapano a disposizione.
- ✓ Punta adatta a disposizione (Ø 7 mm, per il montaggio della rosetta tonda inoltre Ø 6 mm).
- ✓ Cacciavite PH2 a disposizione.
- ✓ Righello a disposizione.

1. Rimuovere la serratura a incasso.



2. Misurare la distanza (distanza degli assi di rotazione dal quadro maniglia e dal cilindro).



3. Rimontare la serratura a incasso.



4. Inserire il quadro maniglia nella serratura a incasso.



5. Applicare la maschera di foratura sul quadro maniglia.



6. Allineare la maschera di foratura in verticale con l'ausilio della scala graduata.

7. Segnare i punti da forare sulla porta.



8. Rimuovere la maschera di foratura e il quadro maniglia.



9. Rimuovere la serratura a incasso.



10. Praticare i fori necessari.



11. Rimontare la serratura a incasso.



## 7. Montaggio della maniglia

- ✓ Porta già forata.
- ✓ Cacciavite PH2 a disposizione.
- ✓ Cacciavite TX15 a disposizione.
- ✓ Calibro a corsoio a disposizione.
- ✓ Sega a disposizione.

1. Smontare il maniglione antipanico, come indicato nella documentazione del produttore, fino alla piastra di alloggiamento.

2. Misurare lo spessore della porta e determinare la lunghezza del quadro maniglia.



*PS* (con coprimaniglia)		*PO* (con rosetta tonda)	
BKS (maniglione)	Spessore porta - 27,8 ± 1,5 mm	BKS (barra a spinta)	Spessore porta + 36,8 ± 2,5 mm
BKS (barra a spinta)	Spessore porta - 36,8 ± 2,5 mm		
CISA quadro maniglia di 8 mm	Spessore porta - 27,3 ± 0,5 mm		
CISA quadro maniglia di 9 mm	Spessore porta - 19,3 ± 0,5 mm		

3. Accorciare il quadro maniglia con una sega adatta.



4. È possibile richiedere le viti non incluse nella fornitura al fabbricante del maniglione antipanico.



### NOTA

#### Dati del fabbricante del maniglione antipanico

Il fabbricante del maniglione antipanico può fissare ulteriori requisiti per le viti, riguardanti, tra le altre cose, la resistenza e la lunghezza.

- Prestare attenzione alla documentazione del fabbricante del maniglione antipanico.



5. Inserire i dadi a manicotto e la protezione del quadro maniglia nella piastra di fissaggio.



6. Inserire l'anello distanziatore nell'apertura del dado a manicotto.
  - 23
  - 24
  - 25
7. Inserire il supporto del modulo nella piastra di fissaggio.
  - 26
8. Spingere il supporto del modulo verso l'alto.
  - 27
  - ↳ Il supporto del modulo è innestato.
9. Avvitare il supporto del modulo sulla piastra di fissaggio con le viti da 16 mm (PH2).
  - 28
  - 29
10. Applicare il quadro maniglia nella maniglia.
  - 30
11. Inserire il supporto del modulo con la piastra di fissaggio nel lato esterno della porta.
  - 31
12. Per la versione senza MO: inserire il cilindro cieco.
  - 32
13. Per la versione senza MO: avvitare il cilindro cieco.
  - 33
14. Per PO (rosetta tonda): avvitare saldamente la base della rosetta tonda (PH2).
  - 34
  - 35
  - 36
  - 37
  - 38
15. Per PO (rosetta tonda): applicare la copertura sulla base della rosetta tonda.
  - 39
16. Avvitare saldamente la piastra di alloggiamento del maniglione antipanico (TX25).
  - 40
  - 41
17. Prestare attenzione alle possibili regole specifiche del fabbricante per il fissaggio della piastra di alloggiamento.
  - 42
18. Fissare il maniglione antipanico seguendo le regole del fabbricante (ad es. vite senza testa)
  - 43
19. Posizionare la cover in alto sulla piastra di fissaggio.
  - 44
20. Chiudere la cover in basso.
  - 45
21. Spingere la cover verso l'alto.
  - 46
22. Premere saldamente l'inserto.
  - 47
23. Applicare la maniglia esterna.
  - 48
24. Avvitare saldamente la maniglia esterna con la vite senza testa (TX15).
  - 49

- ↳ La SmartHandle AX Advanced è completamente montata.



## 8. Smontaggio della maniglia (maniglione antipanico)

- ✓ Chiave esagonale da 1,5 mm disponibile.

1. Smontare la maniglia procedendo nella sequenza opposta rispetto al montaggio.
2. Allentare la cover flettendo verso l'esterno l'inserto con l'attrezzo speciale.
3. Inserire una chiave esagonale da 1,5 mm nel foro dell'alloggiamento del quadro maniglia nel supporto del modulo.



4. Girare la chiave esagonale dal lato sul quale si trova il foro e contemporaneamente tirare la maniglia esterna.



- ↳ La SmartHandle AX Advanced è smontata.

## 9. Sostituzione delle batterie



### NOTA

#### Malfunzionamenti dovuti a contatto insufficiente o a scarichi diversi

Superfici di contatto troppo piccole/contaminate o diverse batterie scariche possono portare a malfunzionamenti.

1. Utilizzare esclusivamente batterie autorizzate da SimonsVoss.
2. Non toccare con le mani i contatti delle nuove batterie.
3. Utilizzare guanti puliti e privi di grasso.
4. Sostituire sempre tutte le batterie contemporaneamente.

- ✓ Attrezzo speciale a disposizione.

- ✓ Guanti a disposizione.

1. Inserire l'attrezzo speciale nell'inserto della cover della parte elettronica.



2. Con l'attrezzo speciale, flettere l'inserto della cover con cautela.



3. Spingere la cover verso il basso.



- ↳ La cover si sblocca.

4. Rimuovere la cover.



5. Con l'attrezzo speciale, sganciare la clip del modulo delle batterie.



6. Rimuovere il modulo delle batterie.



7. Con l'attrezzo speciale, sganciare la clip delle batterie.



8. Rimuovere le batterie superiori.



9. Sollevare la linguetta intermedia verso il bordo con cautela.









10. Rimuovere le batterie inferiori.



11. Inserire due batterie nuove in modo tale che i poli positivi si tocchino (CR2450).



- ↳ Linguetta intermedia visibile sulle batterie inferiori.

12. Inserire due batterie nuove in modo tale che i poli positivi si tocchino (CR2450).  
 63
13. Agganciare nuovamente la clip delle batterie.  
 64
14. Reinserire il modulo delle batterie nel supporto del modulo.  
 65
15. Con l'attrezzo speciale, riagganciare la clip del modulo delle batterie.  
 66  
↳ La SmartHandle AX Advanced emette tre segnali acustici.
16. Posizionare la cover in alto sulla piastra di fissaggio.  
 67
17. Chiudere la cover in basso.  
 68
18. Premere contemporaneamente la cover contro la porta e verso l'alto.  
 69  
↳ La cover si innesta.
19. Premere saldamente l'inserito.  
 70  
↳ Le batterie sono sostituite.

## 10. Dati tecnici

Range di temperature (esercizio)	da -25 °C a +60 °C
Tipo di batteria	4 × CR2450 3V al litio
Marca delle batterie	<ul style="list-style-type: none"> <li>■ Murata</li> <li>■ Panasonic</li> <li>■ Varta</li> </ul>
Grado di protezione	Fino a IP66 (variante WP)

### Emissioni radio

15,24 kHz - 72,03 kHz Solo per i codici articolo: SV-S3.*AM.G2*, SV-S3.*A.G2*, SI-S3.*LN*	10 dBµA/m (3 m distanza)
13,560006 MHz - 13,560780 MHz Solo per i codici articolo: SV-S3.*AM.G2*, SV-S3.*A.G2*, SI-S3.*M.WO*, SI-S3.*LN*	1,04 dBµA/m (3 m distanza)
868,000 MHz - 868,600 MHz / 869,700 MHz - 870,000 MHz Solo per i codici articolo: SI-S3.*M.WO*, SI-S3.*LN*	<25 mW ERP
2402 MHz - 2480 MHz Solo per i codici articolo: SV-S3.*AM.G2*, SV-S3.*A.G2*, SI-S3.*M.WO*, SI-S3.*LN*	2,5 mW

## 11. Dichiarazione di conformità

Het bedrijf SimonsVoss Technologies GmbH verklaart hierbij dat de artikelen (SI-S3.\*M.VCN\*, SV-S3.\*M.G2\*, SV-S3.\*AM.G2\*, SV-S3.\*A.G2\*, SI-S3.\*M.WO\*, SI-S3.\*LN\*) voldoet aan de volgende richtlijnen:

- 2014/53/UE -RED-  
o per il Regno Unito: Normativa del Regno Unito 2017 n. 1206  
-Apparecchiature radio-
- 2011/65/UE -RoHS-  
o per il Regno Unito: Normativa del Regno Unito 2012 n. 3032 -RoHS-



Il testo integrale della dichiarazione di conformità UE è disponibile al seguente indirizzo Internet: [www.simons-voss.com/it/certificati.html](http://www.simons-voss.com/it/certificati.html).  
Il testo integrale della dichiarazione di conformità UK è disponibile al seguente indirizzo Internet: [www.simons-voss.com/it/certificati.html](http://www.simons-voss.com/it/certificati.html).

## 12. Supporto e ulteriori informazioni

### Materiale informativo/Documents

<https://www.simons-voss.com/it/documents.html>

<https://www.smartintego.com/int/home/infocenter/documentation>

### Dichiarazioni di conformità

<https://www.simons-voss.com/it/certificati.html>

### Informazioni sullo smaltimento

- Il dispositivo (SI-S3.\*M.VCN\*, SV-S3.\*M.G2\*, SV-S3.\*AM.G2\*, SV-S3.\*A.G2\*, SI-S3.\*M.WO\*, SI-S3.\*LN\*) non va smaltito fra i rifiuti domestici, ma conferito presso un centro di raccolta comunale per rifiuti elettronici speciali in conformità con la Direttiva Europea 2012/19/UE.
- Riciclare le batterie guaste o esauste ai sensi della Direttiva Europea 2006/66/CE.
- Osservare le disposizioni locali in materia di smaltimento speciale delle batterie.
- Conferire l'imballaggio presso un punto di raccolta ai fini del riciclaggio ecologico.



### Supporto tecnico

+49 (0) 89 / 99 228 333

### E-mail

[support-simonsvoss@allegion.com](mailto:support-simonsvoss@allegion.com)

[si-support-simonsvoss@allegion.com](mailto:si-support-simonsvoss@allegion.com)

### FAQ

<https://faq.simons-voss.com/otrs/public/>

SimonsVoss Technologies GmbH, Feringastr. 4, D-85774 Unterfoehring, Germania

## 1. Generelle sikkerhedshenvisninger

*Signalord: Mulige direkte virkninger i tilfælde af manglende overholdelse*  
**ADVARSEL:** Død eller alvorlig personskade (muligt, men usandsynligt), **FOR-SIGTIG:** Mindre skade, **OPMÆRKSOMHED:** Materiel skade eller fejlfunktion, **BEMÆRK:** Lidt eller ingen



### ADVARSEL

#### Spærret adgang

Hvis komponenter er fejlagtigt monteret og/eller programmeret, kan adgang til en dør forblive spærret. For følgeskader, der skyldes spærret adgang, fx til personer, der er sårede eller i fare, tingsskader eller andre skader, hæfter SimonsVoss Technologies GmbH ikke!

#### Blokeret adgang gennem manipulation af produktet

Hvis du selv ændrer produktet, kan der opstå funktionsfejl, og adgang via en dør kan blokeres.

- Modificer kun produktet, når det er nødvendigt, og kun på den måde, der er beskrevet i dokumentationen.

#### Batteri må ikke indtages. Forbrændingsfare på grund af farlige stoffer

Dette produkt indeholder litium-knappceller. Hvis knapcellen sluges, kan det medføre alvorlige indre forbrændinger inden for to timer og dødsfald.

1. Opbevar nye og brugte batterier uden for børns rækkevidde.
2. Hvis batterirummet ikke kan lukkes ordentligt, må produktet ikke længere benyttes, og det opbevares uden for børns rækkevidde.
3. Hvis du tror, at batterier er blevet slugt eller befinder sig i en legemsdel, skal du straks søge lægehjælp.

#### Eksplodingsfare på grund af forkert batteritype

Isætning af den forkerte batteritype kan resultere i en eksplosion.

- Brug kun de batterier, der er specificeret i de tekniske data.



### FORSIGTIG

#### Brandfare ved batterier

Batterierne kan udgøre en brand- eller forbrændingsfare ved forkert behandling.

1. Forsøg ikke at oplade, åbne, opvarme eller brænde batterierne.
2. Kortslut ikke batterierne.

### OPMÆRKSOMHED

#### Beskadigelse på grund af elektrostatisk afladning (ESD) med huset åbent

Dette produkt indeholder elektroniske komponenter, som kan blive beskadiget på grund af elektrostatisk afladning.

1. Brug ESD-beskyttede arbejdsmaterialer (f.eks. jordforbindelsesbånd).
2. Opret jordforbindelse før arbejde, hvor du kan komme i kontakt med elektronikken. Indfat i denne forbindelse jordforbundne metaloverflader (f.eks. dørkarme, vandør eller varmeventiler).

#### Beskadigelse på grund af væske

Dette produkt indeholder elektroniske og/eller mekaniske komponenter, som kan blive beskadiget på grund af alle typer væsker.

- Hold væsker væk fra elektronikken.

#### Beskadigelse på grund af aggressive rengøringsmidler

Produktets overflade kan blive beskadiget på grund af uegnede rengøringsmidler.

- Brug kun rengøringsmidler, der er velegnede til kunststof- og metaloverflader.

#### Beskadigelse på grund af mekanisk påvirkning

Dette produkt indeholder elektroniske komponenter, som kan blive beskadiget på grund af alle typer mekanisk påvirkning.

1. Undgå at berøre elektronikken.
2. Undgå at udsætte elektronikken for andre mekaniske påvirkninger.

#### Beskadigelse på grund af fejltlilslutning

Dette produkt indeholder elektroniske komponenter, som kan blive beskadiget på grund af fejltlilslutning af spændingskilden.

- Sørg for ikke at fejltlilslutte spændingskilden (batterier eller netdele).

#### Driftsforstyrrelse på grund af radiostøj

Dette produkt kan under visse omstændigheder påvirkes af elektromagnetiske eller magnetiske forstyrrelser.

- Montér eller anbring ikke produktet umiddelbart i nærheden af enheder, som kan medføre elektromagnetiske eller magnetiske forstyrrelser (strømforsyninger!).

#### Kommunikationsfejl på grund af metaloverflader

Dette produkt kommunikerer trådløst. Metaloverflader kan reducere produktets rækkevidde væsentligt.

- Montér eller anbring ikke produktet på eller i nærheden af metaloverflader.



### BEMÆRK

#### Korrekt anvendelse

SimonsVoss-produkter er kun beregnet til åbning og lukning af døre og sammenlignelige genstande.

- Anvend ikke SimonsVoss-produkter til andre formål.

#### Funktionsfejl på grund af dårlig kontakt eller anden afladning

For små / forurenede kontaktområder eller forskellige afladede batterier kan føre til funktionsfejl.

1. Anvend kun batterier, som er frigivet af SimonsVoss.
2. Berør ikke de nye batteriers kontakter med hænderne.
3. Anvend rene og fedtfrie handsker.
4. Skift derfor altid alle batterier samtidigt.

#### Afvigende tidspunkter ved G2-lukninger

Den interne tidsenhed ved G2-lukninger har en teknisk betinget tolerance på op til ± 15 minutter om året.

#### Krævede kvalifikationer

Installation og idriftsættelse kræver specialiseret viden.

- Kun uddannet personale må installere og idriftsætte produktet.

Ændringer eller tekniske videreudviklinger kan ikke udelukkes og kan foretages uden forudgående varsel.

Den tyske sprogversion er den originale brugsanvisning. Andre sprog (udkast på kontraktspøget) er oversættelser af de originale instruktioner.

Læs og følg alle installations-, installations- og idriftsættelsesinstruktioner. Overfør disse instruktioner og eventuel vedligeholdelsesinstruktion til brugeren.

## 2. Produktspecifikke sikkerhedsanvisninger

### OPMÆRKSOMHED

#### Vanskelig samling på grund af gevindbøsninger, der presses ud

Gevindbøsningerne i beslaget er monteret med prespasning Et for stort tryk, når beslaget skrues fast på fastgørelsespladen, kan få gevindbøsningerne til at glide ud af beslaget.

1. Tryk ikke på skruerne, når du skruer modulholderen fast.
2. Brug en finger på enderne af gevindbøsningerne til at holde imod, mens du skruer.



**BEMÆRK****Dokumentation fra producenten af panikstangen**

Se panikstangsproducentens dokumentation for mere information om nødvendige dele, krav og monteringspecifikationer.

- Læs også denne dokumentation før monteringen påbegyndes.

### 3. Leveringsomfang

- SmartHandle AX Advanced Panikbeslag med bredt skilt

- Specialværktøj
- Kort vejledning

Ikke inkluderet:

- Panikstang
- Skruer til fastgørelse af selve panikstangen

### 4. Montering med skilt (\*PS\*)



### 5. Montering med rund roset (\*PO\*)



### 6. Forbered døren (boreskabelon)

- ✓ Blyant eller ridsenål til stede.
- ✓ Boremaskine til rådighed.
- ✓ Passende bor til rådighed (Ø 7 mm, til montering af runde rosetter desuden Ø 6 mm).
- ✓ PH2-skruetrækker til rådighed.
- ✓ Lineal er tilgængeligt.

1. Fjern indstikslåsen.



2. Mål afstanden (afstanden mellem firkantens og cylinderens rotationsakser).



3. Monter indstikslåsen.



4. Sæt firkanten ind i indstikslåsen.



5. Sæt boreskabelonen på firkanten.



6. Juster boreskabelonen lodret ved hjælp af den påtrykte skala.

7. Marker de punkter, der skal bores på døren.



8. Fjern boreskabelonen og firkanten.



9. Fjern indstikslåsen.



10. Bor de nødvendige huller.



11. Monter indstikslåsen.



## 7. Monter beslaget

- ✓ Døren er forboret.
- ✓ PH2-skruetrækker til rådighed.
- ✓ TX15-skruetrækker til rådighed.
- ✓ Måleapparat til kalibre er tilgængeligt.
- ✓ Sav er tilgængeligt.

1. Afmonter panikstangen som i producentens dokumentation indtil holderpladen.
2. Mål dørens tykkelse, og bestem firkantens længde.



*PS* (med skilt)		*PO* (med rund roset)	
BKS (stang-håndtag)	Dørtykkelse - 27,8 ± 1,5 mm	BKS (trykstang)	Dørtykkelse + 36,8 ± 2,5 mm
BKS (trykstang)	Dørtykkelse - 36,8 ± 2,5 mm		
CISA 8 mm firkant	Dørtykkelse - 27,3 ± 0,5 mm		
CISA 9 mm firkant	Dørtykkelse - 19,3 ± 0,5 mm		

3. For X: Afkort firkanten med en egnet sav.



4. Få de skruer, der ikke er inkluderet i leveringen, fra producenten af din panikstang.

**BEMÆRK****Oplysninger om producenten af panikstangen**

Producenten af panikstangen kan have yderligere krav til boltene, herunder styrke og længde.

- Følg panikstangsproducentens dokumentation.



5. Sæt hylstermøtrikkerne og firkantbeskyttelsen ind i fastgørelsespladen.



6. Placer afstandsringen i åbningen på hylstermøtrikken.



7. Sæt modulholderen ind i fastgørelsespladen.



8. Skub modulholderen opad.



9. Skru modulholderen fast til fastgørelsespladen med 12 mm skruer (PH2).























10. Sæt firkanten ind i beslaget.





11. Stik modulholderen med fastgørelsespladen ind i dørens yderside.



12. For ikke-MO: Indsæt blindcylindren.  32
  13. For ikke-MO: Skru blindcylindren fast.  33
  14. Til PO (rund roset): Skru den runde rosetbund fast (PH2).  34  
 35  
 36  
 37  
 38
  15. Til PO (rund rose): Skub dækslet på den runde rosetbund.  39
  16. Skru monteringspladen til panikstangen fast (TX25).  40  
 41
  17. Overhold eventuelle producentspecifikke specifikationer for fastgørelse af monteringspladen.  42
  18. Fastgør panikstangen i henhold til producentens specifikationer (f.eks. med en skrue).  43
  19. Placer dækslet oven på fastgørelsespladen.  44
  20. Klap dækslet ned.  45
  21. Skub dækslet opad.  46
  22. Tryk indlægget fast.  47
  23. Sæt det udvendige håndtag på.  48
  24. Brug gevindskruen til at skru det udvendige håndtag (TX15) fast.  49  
 50
-  SmartHandle AX Advanced færdigmonteret.  50

## 8. Afmontering af beslag (panikbeslag)

- ✓ Anvend 1,5 mm unbrakonøgle.
1. Afmonter beslaget i omvendt rækkefølge i forhold til monteringen.
  2. Løsn dækslet ved at bøje indlægget udad med specialværktøjet.
  3. Sæt en 1,5 mm sekskantnøgle ind i det dertil beregnede hul i firkantholderen i modulholderen.  51
  4. Bøj sekskantnøglen til den side, hvor hullet er placeret, og træk samtidig i det udvendige håndtag.  52
-  SmartHandle AX Advanced er afmonteret.

## 9. Udskiftning af batterier



### BEMÆRK

#### Funktionsfejl på grund af dårlig kontakt eller anden afladning

For små / forurenede kontaktområder eller forskellige afladede batterier kan føre til funktionsfejl.

1. Anvend kun batterier, som er frigivet af SimonsVoss.
2. Berør ikke de nye batteriers kontakter med hænderne.
3. Anvend rene og fedtfrie handsker.
4. Skift derfor altid alle batterier samtidigt.

- ✓ Specialværktøj er tilgængeligt.
- ✓ Handsker er tilgængeligt.

1. Sæt specialværktøjet ind i dækslet på elektroniksiden.  53
2. Brug specialværktøjet til at bøje dækslet forsigtigt op.  54
3. Skub dækslet ned.  55  
 Dækslet er ikke låst op.
4. Fjern dækslet.  56
5. Løsn batterimodulets clips med specialværktøjet.  57
6. Fjern batterimodulet.  58
7. Løsn batteriklippen med specialværktøjet.  59
8. Fjern de øverste batterier.  60
9. Bøj forsigtigt den mellemliggende fjeder til siden.
10. Fjern de nederste batterier.  61
11. Sæt to nye batterier i med de positive poler i berøring (type CR2450).  62  
 Den mellemliggende fjeder er synlig over de nederste batterier.
12. Sæt to nye batterier i med de positive poler i berøring (type CR2450).  63
13. Sæt batteriklippen på plads igen.  64
14. Sæt batterimodulet tilbage i modulholderen.  65
15. Brug specialværktøjet til at sætte batterimodulets clips på plads igen.  66  
 SmartHandle AX Advanced bipper tre gange.
16. Placer dækslet oven på fastgørelsespladen.  67
17. Klap dækslet ned.  68
18. Tryk dækslet mod døren og skub det samtidig opad.  69  
 Dækslet klikkes på plads.
19. Tryk indlægget fast.  70

↳ Batterierne er udskiftet.

## 10. Tekniske data

Temperaturområde (drift)	-25 °C til +60 °C
Batteritype	4× CR2450 3V lithium
Batterierproducent	<ul style="list-style-type: none"> <li>■ Murata</li> <li>■ Panasonic</li> <li>■ Varta</li> </ul>
IP-kapslingsklasse	Op til IP66 (WP-variant)

### Radio emissies

15,24 kHz - 72,03 kHz Kun for artikelnumre: SV-S3.*AM.G2*, SV-S3.*A.G2*, SI-S3.*LN*	10 dBµA/m (3 m afstand)
13,560006 MHz - 13,560780 MHz Kun for artikelnumre: SV-S3.*AM.G2*, SV-S3.*A.G2*, SI-S3.*M.WO*, SI-S3.*LN*	1,04 dBµA/m (3 m afstand)
868,000 MHz - 868,600 MHz / 869,700 MHz - 870,000 MHz Kun for artikelnumre: SI-S3.*M.WO*, SI-S3.*LN*	<25 mW ERP
2402 MHz - 2480 MHz Kun for artikelnumre: SV-S3.*AM.G2*, SV-S3.*A.G2*, SI-S3.*M.WO*, SI-S3.*LN*	2,5 mW

## 11. Overensstemmelseserklæring

Herved erklærer SimonsVoss Technologies GmbH at varen (SI-S3.\*M.VCN\*, SV-S3.\*M.G2\*, SV-S3.\*AM.G2\*, SV-S3.\*A.G2\*, SI-S3.\*M.WO\*, SI-S3.\*LN\*) overholder følgende retningslinjer:

- 2014/53/EU -RED- eller for Storbritannien: UK lovbekendtgørelse 2017 nr. 1206 -Radioudstyr-
- 2011/65/EU -RoHS- eller for Storbritannien: UK lovbekendtgørelse 2012 nr. 3032 -RoHS-



Den fulde ordlyd af EU-overensstemmelseserklæringen er tilgængelig på følgende internetadresse: [www.simons-voss.com/dk/certifikater.html](http://www.simons-voss.com/dk/certifikater.html).  
Den fulde ordlyd af UK-overensstemmelseserklæringen er tilgængelig på følgende internetadresse: [www.simons-voss.com/dk/certifikater.html](http://www.simons-voss.com/dk/certifikater.html).

## 12. Hjælp og flere oplysninger

### Infomateriale/dokumenter

<https://www.simons-voss.com/dk/dokumenter.html>  
<https://www.smartintego.com/int/home/infocenter/documentation>

### Overensstemmelseserklæring

<https://www.simons-voss.com/dk/certifikater.html>

### Oplysninger om bortskaffelse

- Enheden (SI-S3.\*M.VCN\*, SV-S3.\*M.G2\*, SV-S3.\*AM.G2\*, SV-S3.\*A.G2\*, SI-S3.\*M.WO\*, SI-S3.\*LN\*) må ikke bortskaffes med husholdningsaffaldet, men skal afleveres på den kommunale affaldsplads, jf. det europæiske direktiv 2012/19/EU.
- Brugte eller defekte batterier skal genanvendes jf. det europæiske direktiv 2006/66/EG.
- Overhold de lokale bestemmelser for separat bortskaffelse af batterier.
- Aflever emballagen til miljørigtig genanvendelse.



### Teknisk support

+49 (0) 89 / 99 228 333

### e-mail

[support-simonsvoss@allegion.com](mailto:support-simonsvoss@allegion.com)  
[si-support-simonsvoss@allegion.com](mailto:si-support-simonsvoss@allegion.com)

### FAQ

<https://faq.simons-voss.com/otrs/public.pl>

SimonsVoss Technologies GmbH, Feringastr. 4, D-85774 Unterföhring, Tyskland

## 1. Allmänna säkerhetsanvisningar

*Signalord: Eventuella omedelbara effekter av bristande efterlevnad*  
**VARNING:** Död eller allvarlig skada (möjligt, men osannolikt), **OBSERVERA:** Liten skada, OBS: Skador på egendom eller fel, INFO: Låg eller ingen



### VARNING

#### Tillgång spärrad

Felaktigt installerade och/eller programmerade komponenter kan leda till att dörrar spärras. SimonsVoss Technologies GmbH ansvarar inte för konsekvenserna av felaktig installation såsom spärrat tillträde till skadade personer eller personer i risksituationer, materiella skador eller andra typer av skador.

#### Blockerad åtkomst genom manipulering av produkten

Om du ändrar produkten på egen hand kan fel uppstå och åtkomst via en dörr kan blockeras.

- Ändra endast produkten vid behov och endast på det sätt som beskrivs i dokumentationen.

#### Svälj inte batterier. Risk för brännskador på grund av farliga ämnen.

Den här produkten innehåller litiumknappcells-batterier. Om man råkar svälja ett knappcells-batteri kan allvarliga inre brännskador uppstå inom bara två timmar vilket i sin tur kan leda till döden.

- Förvara nya och förbrukade batterier utom räckhåll för barn.
- Upphör att använda produkten och förvara den utom räckhåll för barn om batterilocket inte går att stänga ordentligt.
- Uppsök omedelbart läkare om du misstänker att batterier har svalts eller befinner sig i någon kroppsdela.

#### Explosionsrisk på grund av felaktigt batterityp

Att sätta i fel typ av batteri kan leda till en explosion.

- Använd endast de batterier som anges i de tekniska data.



### OBSERVERA

#### Brandrisk som utgår från batterier

De isatta batterierna kan orsaka brand eller brännskador om de hanteras på ett felaktigt sätt.

- Försök inte att ladda upp, öppna eller värma upp batterierna.
- Kortslut inte batterierna.

### OBS

#### Skador på grund av elektrostatisk urladdning (ESD) när hölet är öppet

Den här produkten innehåller elektroniska komponenter som kan skadas av elektrostatiska urladdningar.

- Använd alltid ESD-anpassat arbetsmaterial (t.ex. jordningsarmband).
- Jorda dig före alla arbeten där du kan komma i kontakt med elektronik. Det gör du genom att fatta tag i en jordad metallta (såsom dörrkarmar, vattenrör eller värmeventiler).

#### Skada på grund av vätskor

Den här produkten innehåller elektroniska och/eller mekaniska komponenter som kan skadas av alla typer av vätskor.

- Låt inte elektroniken komma i kontakt med vätskor.

#### Skada på grund av aggressiva rengöringsmedel

Ytan på den här produkten kan skadas om olämpliga rengöringsmedel används.

- Använd endast rengöringsmedel som lämpar sig för plast- och metalltyper.

#### Skada på grund av mekanisk påverkan

Den här produkten innehåller elektroniska komponenter som kan skadas av alla typer av mekanisk påverkan.

- Undvik att vidröra elektroniken.
- Undvik annan mekanisk påverkan på elektroniken.

#### Skada på grund av polvändning

Den här produkten innehåller elektroniska komponenter som kan skadas på grund av polvändning i spänningskällan.

- Vänd inte spänningskällans poler (batterier resp. nätdelar).

#### Driftstörning på grund av radiostörning

Den här produkten kan i vissa fall påverkas av elektromagnetiska eller magnetiska störningar.

- Produkten ska inte monteras eller placeras i omedelbar närhet av utrustning som kan orsaka elektromagnetiska eller magnetiska störningar (switchade nättaggregat!).

#### Kommunikationsstörning på grund av metalltytor

Den här produkten kommunicerar trådlöst. Metalltytor kan minska produktens räckvidd avsevärt.

- Produkten ska inte monteras eller placeras på eller i närheten av metalltytor.



### INFO

#### Avsedd användning

SimonsVoss-produkter är uteslutande avsedda för öppning och stängning av dörrar och liknande.

- Använd inte SimonsVoss-produkter för andra syften.

#### Funktionsstörningar på grund av dålig dålig kontakt eller annan urladdning

För små / kontaminerade kontaktytor eller olika urladdade batterier kan leda till funktionsstörningar.

- Används endast batterier som är godkända av SimonsVoss.
- Vidrör inte de nya batteriernas kontakter med händerna.
- Använd rena och fettfria handskar.
- Byt alltid alla batterier samtidigt.

#### Avvikande tider vid G2-lås

G2-låsens interna tidsenhet har en tekniskt betingad tolerans på upp till  $\pm 15$  minuter per år.

#### Kvalifikationer krävs

Installation och idrifttagning kräver specialiserad kunskap.

- Endast utbildad personal får installera och driftsätta produkten.

Ändringar eller teknisk vidareutveckling kan inte uteslutas och kan komma att genomföras utan föregående meddelande om detta.

Den tyska språkversionen är den ursprungliga bruksanvisningen. Andra språk (utarbetade på kontraktsspråket) är översättningar av originalinstruktionerna.

Läs och följ alla installations-, installations- och driftsinstruktioner. Skicka dessa instruktioner och alla underhållsinstruktioner till användaren.

## 2. Produktspecifika säkerhetsanvisningar

### OBS

#### Försvårad montering på grund av att gänghylsor har tryckts ut

Gänghylsorna i handtaget är monterade med en presspassning. Om man trycker för hårt när handtaget skruvas fast på fixeringsplattan kan leda till att gänghylsorna glider på handtaget.

- Tryck inte på skruvarna när modulhållaren skruvas fast.
- Håll emot med ett finger på gänghylsornas ändrar vid fastskruvning.



### INFO

#### Dokumentation från panikregelns tillverkare

I dokumentationen från panikregelns tillverkare finns ytterligare information om nödvändiga delar, villkor och monteringsanvisningar.

- Läs även denna dokumentation innan du påbörjar monteringen.

### 3. Leveransomfång

- SmartHandle AX Advanced Panikhandtag med bred skytt
  - Specialverktyg
  - Snabbguide
- Ingår inte:
- Panikregel
  - Skruvar för montering av panikregel

### 4. Konstruktion med skytt (\*PS\*)



### 5. Konstruktion med rundrosett (\*PO\*)



### 6. Förbereda dörr (borschablon)

- ✓ Stift eller ritsnål finns.
- ✓ Borrmaskin finns.
- ✓ Lämpligt borrstål finns (Ø 7 mm, för montering av rundrosett dessutom Ø 6 mm).
- ✓ PH2-skruvmejsel finns.
- ✓ Linjal finns.

1. Demontera instickslåset.



2. Mät avståndet (vridaxlarnas avstånd vrån fyrkant och cylinder).



3. Montera instickslåset.



4. Stick in fyrkanten i instickslåset.



5. Sätt på borschablonen på fyrkanten.



6. Rikta in borschablonen lodrätt med hjälp av den påtryckta skalan.

7. Markera borrhållarna på dörren.



8. Ta bort borschablonen och fyrkanten.



9. Demontera instickslåset.



10. Borra de hål som behövs.



11. Montera instickslåset.



### 7. Montera handtag

- ✓ Dörr förborrad.
- ✓ PH2-skruvmejsel finns.
- ✓ TX15-skruvmejsel finns.
- ✓ Mätare för kalibreringsmått finns.
- ✓ Såg finns.

1. Demontera panikregeln fram till fästplattan enligt tillverkarens dokumentation.

2. Mät dörrjockeleken och fastställ fyrkantens längd.



*PS* (med skytt)		*PO* (med rundrosett)	
BKS (stång-handtag)	Dörrjocklek - 27,8 ± 1,5 mm	BKS (tryckstång)	Dörrjocklek + 36,8 ± 2,5 mm
BKS (tryckstång)	Dörrjocklek - 36,8 ± 2,5 mm		
CISA 8 mm fyrkant	Dörrjocklek - 27,3 ± 0,5 mm		
CISA 9 mm fyrkant	Dörrjocklek - 19,3 ± 0,5 mm		

3. Korta av fyrkanten med en lämplig såg.



4. Beställ de skruvar som inte medföljer leveransen från panikregelns tillverkare.



#### INFO

#### Uppgifter från panikregelns tillverkare

Panikregelns tillverkare kan ställa ytterligare krav på skruvarna, bland annat vad gäller hållfasthet och längd.

- Beakta även dokumentationen från panikregelns tillverkare.



5. Sätt i hylsmutterarna och fyrkantsskyddet i fixeringsplattan.



6. Placera distansringen på hylsmuttern i öppningen



7. Sätt i modulhållaren i fixeringsplattan.



8. Skjut modulhållaren uppåt.



- ↳ Modulhållaren hakar i.

9. Skruva fast modulhållaren på fixeringsplattan med 16 mm-skruvarna (PH2).



10. Stick in fyrkanten i handtaget.



11. Sätt i modulhållaren med fixeringsplattan på dörrens ytersida.



12. För icke-MO: Sätt i blindcylindern.

























13. För icke-MO: Skruva fast blindcylindern.







14. För PO (rundrosett): Skruva fast rundrosettens bas (PH2).



- 36 
  - 37 
  - 38 
  15. För PO (rundrosett): Sätt på skyddet på rundrosettens bas. 
  16. Skruva fast panikregelns fästplatta (TX25). 
  - 40 
  - 41 
  17. Beakta eventuella tillverkarspecifika uppgifter avseende fastsättning av fästplattan. 
  - 42 
  18. Montera panikregeln enligt tillverkarens anvisningar (t.ex. stoppskruv). 
  - 43 
  19. Sätt på kåpan upptill på fixeringsplattan. 
  - 44 
  20. Fäll kåpan nedåt. 
  - 45 
  21. Skjut kåpan uppåt. 
  - 46 
  22. Tryck fast inlägget. 
  - 47 
  23. Sätt fast ytterhandtaget. 
  - 48 
  24. Skruva fast ytterhandtaget med stoppskraven (TX15). 
  - 49 
- ↳ SmartHandle AX Advanced är färdigmonterat.

## 8. Demontera handtag (panikhandtag)

- ✓ 1,5 mm sexkantsnyckel finns.
1. Demontera handtaget i omvänd ordningsföljd jämfört med montering.
  2. Lossa kåpan genom att böja inlägget utåt med hjälp av specialverktyget.
  3. Sätt i en 1,5 mm-insexnyckel i hålet på fyrkantsfästet i modulhållaren. 
  - 51 
  4. Böj insexnyckeln åt den sida där hålet sitter och dra samtidigt i ytterhandtaget. 
  - 52 
- ↳ SmartHandle AX Advanced har demonterats.

## 9. Byt batterier.







































### INFO

#### Funktionsstörningar på grund av dålig dålig kontakt eller annan urladdning

För små / kontaminerade kontaktytor eller olika urladdade batterier kan leda till funktionsstörningar.

1. Används endast batterier som är godkända av SimonsVoss.
2. Vidrör inte de nya batteriernas kontakter med händerna.
3. Använd rena och fettfria handskar.
4. Byt alltid alla batterier samtidigt.

- ✓ Specialverktyg finns.
- ✓ Handskar finns.

1. Sätt i specialverktyget i kåpinlägget på elektroniksidan. 
  - 53 
  2. Böj försiktigt upp kåpinlägget med specialverktyget. 
  - 54 
  3. Skjut kåpan nedåt. 
  - 55 
  - ↳ Kåpan är lossad.
  4. Avlägsna kåpan. 
  - 56 
  5. Lossa batterimodulens klämmor med specialverktyget. 
  - 57 
  6. Avlägsna batterimodulen. 
  - 58 
  7. Lossa batteriets klämmor med specialverktyget. 
  - 59 
  8. Ta ur de övre batterierna. 
  - 60 
  9. Böj mellanfjäders försiktigt åt sidan.
  10. Ta ur de nedre batterierna. 
  - 61 
  11. Sätt i två nya batterier så att pluspolerna vidrör varandra (typ CR2450). 
  - 62 
  - ↳ Mellanfjäders är synlig ovanför de nedre batterierna.
  12. Sätt i två nya batterier så att pluspolerna vidrör varandra (typ CR2450). 
  - 63 
  13. Haka i batteriklämmorna igen. 
  - 64 
  14. Sätt tillbaka batterimodulen i modulhållaren. 
  - 65 
  15. Haka i batterimodulens klämmor med specialverktyget. 
  - 66 
  - ↳ SmartHandle AX Advanced piper tre gånger.
  16. Sätt på kåpan upptill på fixeringsplattan. 
  - 67 
  17. Fäll kåpan nedåt. 
  - 68 
  18. Tryck kåpan mot dörren och skjut den samtidigt uppåt. 
  - 69 
  - ↳ Kåpan hakar i.
  19. Tryck fast inlägget. 
  - 70 
- ↳ Batterierna är bytta.

## 10. Tekniska data

Temperaturområde (drift)	-25 °C till +60 °C
Batterityp	4× CR2450 3 V litium
Batteritillverkare	<ul style="list-style-type: none"> <li>■ Murata</li> <li>■ Panasonic</li> <li>■ Varta</li> </ul>
IP-kapslingsklass	Upp till IP66 (WP-variant)

## Utsläpp radio

15,24 kHz - 72,03 kHz Endast för artikelnummer: SV-S3.*AM.G2*, SV-S3.*A.G2*, SI-S3.*LN*	10 dBµA/m (3 m avstånd)
13,560006 MHz - 13,560780 MHz Endast för artikelnummer: SV-S3.*AM.G2*, SV-S3.*A.G2*, SI-S3.*M.WO*, SI-S3.*LN*	1,04 dBµA/m (3 m avstånd)
868,000 MHz - 868,600 MHz / 869,700 MHz - 870,000 MHz Endast för artikelnummer: SI-S3.*M.WO*, SI-S3.*LN*	<25 mW ERP
2402 MHz - 2480 MHz Endast för artikelnummer: SV-S3.*AM.G2*, SV-S3.*A.G2*, SI-S3.*M.WO*, SI-S3.*LN*	2,5 mW

## 11. Försäkran om överensstämmelse

Häri förklarar SimonsVoss Technologies GmbH att varan (SI-S3.\*M.VCN\*, SV-S3.\*M.G2\*, SV-S3.\*AM.G2\*, SV-S3.\*A.G2\*, SI-S3.\*M.WO\*, SI-S3.\*LN\*) uppfyller följande riktlinjer:

- 2014/53/EU -RED- eller för Storbritannien: Förenade kungarikets lag 2017 nr 1206 -Radioustrustning-
- 2011/65/EU -RoHS- eller för Storbritannien: Förenade kungarikets lag 2012 nr 3032 -RoHS-



Den fullständiga texten till EU-försäkran om överensstämmelse finns på följande internetadress: [www.simons-voss.com/se/certifikat.html](http://www.simons-voss.com/se/certifikat.html).

Den fullständiga texten till UK-försäkran om överensstämmelse finns på följande internetadress: [www.simons-voss.com/se/certifikat.html](http://www.simons-voss.com/se/certifikat.html).

## 12. Hjälp och ytterligare information

### Infomaterial/dokument

<https://www.simons-voss.com/se/dokument.html>

<https://www.smartintego.com/int/home/infocenter/documentation>

### Försäkringar om överensstämmelse

<https://www.simons-voss.com/se/certifikat.html>

### Avfallshantering

- Produkten (SI-S3.\*M.VCN\*, SV-S3.\*M.G2\*, SV-S3.\*AM.G2\*, SV-S3.\*A.G2\*, SI-S3.\*M.WO\*, SI-S3.\*LN\*) får inte slängas i hushållsoporna utan ska lämnas in på en kommunal uppsamlingsplats för elektriskt och elektroniskt avfall i enlighet med direktiv 2012/19/EU.
- Defekta eller uttjänta batterier ska återvinnas i enlighet med direktiv 2006/66/EG.
- Beakta gällande lokala bestämmelser gällande separat bortskaffande av batterier.
- Avfallshandla förpackningsmaterial på ett miljövänligt sätt.



### Teknisk support

+49 (0) 89 / 99 228 333

[support-simonsvoss@allegion.com](mailto:support-simonsvoss@allegion.com)

[si-support-simonsvoss@allegion.com](mailto:si-support-simonsvoss@allegion.com)

### FAQ

<https://faq.simons-voss.com/otrs/public.pl>

SimonsVoss Technologies GmbH, Feringastr. 4, D-85774 Unterföhring, Tyskland

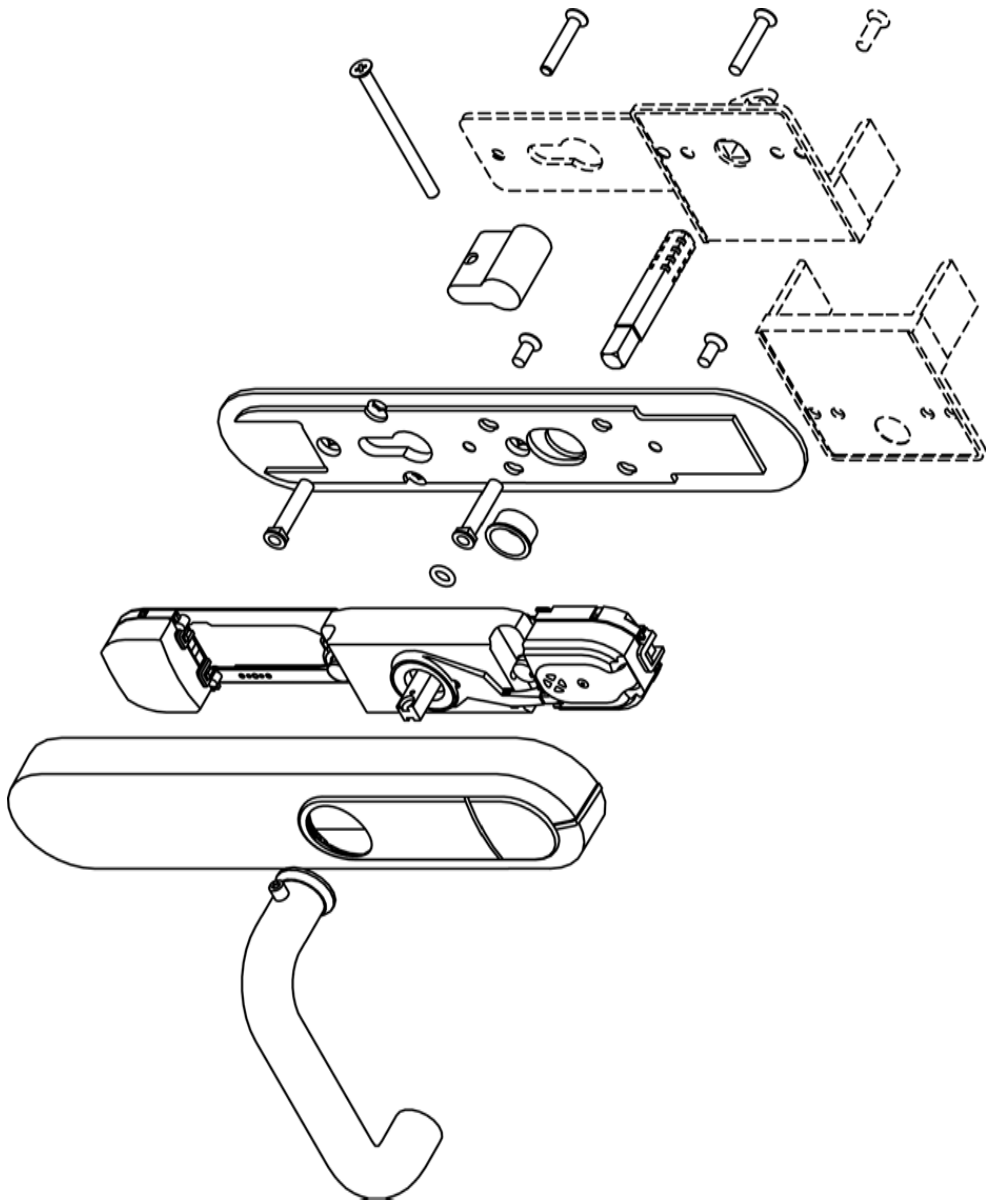

© 2024, SimonsVoss Technologies GmbH, Unterföhring

All rights are reserved. Text, images and diagrams are protected under copyright law.

The content of this document must not be copied, distributed or modified. You can find more information on our website. Subject to technical changes.

SimonsVoss and MobileKey are registered brands belonging to SimonsVoss.

**SimonsVoss**  
technologies

Made in Germany

A BRAND OF

